



USER MANRAL

Network Video Recorder

NVR

CONENTS

SAFETY INSTRUCTION	1
CHAPTER 1 PRODUCT OVERVIEW	3
1.1 REAR PANEL.....	3
1.2 REMOTE CONTROL (ONLY FOR REFERENCE, SUBJECT TO THE PHYSICAL OBJECT).....	4
CHAPTER 2 NVR INSTALLATION & CONNECTION	6
2.2 CONNECTION DIAGRAM.....	6
2.3 POWER SUPPLY CONNECTION.....	7
CHAPTER 3 COMMON OPERATIONS OF NVR	8
3.1 USE OF THE PROVIDED MOUSE.....	8
3.2 USING VIRTUAL KEYBOARD.....	9
3.3 PASSWORD.....	9
3.4 SYSTEM LOGIN.....	14
4.1 START WIZARD.....	15
4.1.1 Start Wizard.....	15
4.1.2 Network Configuration.....	15
4.1.3 Date / time.....	17
4.1.4 IP Camera.....	20
4.1.5 Disk.....	22
4.1.6 Resolution.....	23
4.1.7 Mobile.....	23

4.1.8 Summary.....	25
4.1.9 Cloud Service Configuration.....	25
4.2 INTRODUCTION OF THE REAL-TIME VIEW INTERFACE.....	27
4.2.1 Camera Quick Toolbar.....	28
4.2.2 Taskbar.....	34
4.2.3 System Menu.....	37
CHAPTER 5 NVR SYSTEM SETTINGS.....	39
5.1 CHANNEL.....	39
5.1.1 Channel.....	40
5.1.2 Live configuration.....	47
5.1.3 Image control.....	48
5.1.4 Record and Encode Settings.....	54
5.1.5 Image Capture.....	61
5.1.6 PTZ.....	62
5.1.7 Video Cover.....	71
5.2 STORAGE.....	73
5.2.1 Schedule.....	73
5.2.1.1 Record schedule.....	73
5.2.2 Storage.....	76
5.3 ALARM.....	83
5.3.1 I/O alarm.....	83
5.3.2 Exception.....	87

5.3.3 Combined Alarm	88
5.3.4 Voice Prompts	91
5.3.5 Deterrence	96
5.3.7 Disarming	98
5.4 EVENT	101
5.4.1 Event Settings	101
5.4.2 List Management	131
5.4.3 Statistical analysis	147
5.5 NETWORK	152
5.5.1 General	152
5.5.2 Cloud services	158
5.5.3 DDNS (Dynamic Domain Name Server)	160
5.5.4 Email	161
5.5.5 IP filter	164
5.5.6 Platform Access	165
5.6 SYSTEM SETTINGS	172
5.6.1 System	173
5.6.2 Multi-user management	180
5.6.3 Maintenance	185
5.6.4 IP Camera Maintain	194
5.6.5 Information	198
CHAPTER 6 AI SCENARIO	202

6.1 CROSSING COUNTING SCENARIO	202
<i>6.1.1 Channel</i>	202
<i>6.1.2 Group No</i>	204
<i>6.1.3 Search</i>	205
<i>6.1.4 Setting-up</i>	206
6.2 FACE ATTENDANCE	208
6.3 NON-MOTOR VEHICLE STATISTICS	213
CHAPTER 7 PLAYBACK SEARCH AND BACKUP	217
7.1 USE OF THE SEARCH FUNCTION	217
<i>7.1.1 Playback interface search and playback video recording</i>	220
<i>7.1.2 Sub-Periods</i>	224
<i>7.1.3 Slice Playback</i>	226
<i>7.1.4 External files</i>	227
<i>7.1.5 Event search, playback, and backup</i>	227
<i>7.1.6 Picture search</i>	230
<i>7.1.7 Tag playback</i>	231
<i>7.1.8 AI</i>	232
CHAPTER 8 REMOTE ACCESS THROUGH THE WEB CLIENT	246
8.1 BASIC ENVIRONMENT REQUIREMENTS OF THE SYSTEM	246
8.2 DOWNLOAD AND INSTALLATION OF THE WEB PLUG-IN	247
8.3 WEB CLIENT MANAGEMENT	249

<i>8.3.1 Preview interface</i>	249
<i>8.3.2 Playback</i>	257
<i>8.3.3 Remote Settings</i>	263
<i>8.3.4 Local settings</i>	263
CHAPTER 9 PLAY THE BACKUP VIDEO	265
CHARPTER 10 REMOTE ACCESS VIA A MOBILE DEVICE	269
10.1 RXCAMVIEW	269
10.2 CYBVU	272
CHAPTER XI APPENDIX	275
11.1 FAQs	275
11.2 USE AND MAINTENANCE	278
11.3 RANDOM ATTACHMENTS (SUBJECT TO THE PHYSICAL OBJECT)	279

SAFETY INSTRUCTION

Please read the following safety instruction carefully to avoid personal injuries and prevent the equipment and other connection devices from being damaged.

- The device should be used in compliance with local laws, electrical safety regulations, and fire prevention regulations.
- Use the power supply attached or specified by the manufacturer only. Never operate the equipment by using an unspecified power supply.
- Firmly connect the plug to the power socket. Do not connect several devices to one power adapter.
- Power off the device before connecting and disconnecting accessories and peripherals.
- The NVR should not be placed in a dusty field.
- The NVR should be placed in sealing condition with good ventilation and kept away from sunshine, rain and water. If the equipment is accidentally in contact with water, unplug the power cable immediately and contact your local dealer.
- The NVR includes HDD which produces large amount of heat during operation. Do not block the vents (on the top, bottom and both sides) for cooling the system during operation.
- Never place the NVR in an unstable location. The NVR may fall to cause serious personal injury or death.

- Keep the surface of the NVR clean and dry. Use soft cloth to clean the outer case of NVR and do not use liquid aerosol cleaners.
- If smoke, odor or noise rise from the NVR, turn off the power immediately, unplug the power cable, and then contact your local dealer.
- This product contains a coin/button cell battery. If the battery is swallowed, it can cause severe internal burns in just 2 hours and can lead to death.
- If you think batteries might have been swallowed or placed inside any part of the body, seek immediate medical attention.
- Keep new and used batteries away from children.
- Do not dispose of the battery into fire or a hot oven, or mechanically crush or cut the battery, which may cause an explosion.
- Do not leave the battery in an extremely high temperature surrounding environment, which may result in an explosion or the leakage of flammable liquid or gas.
- Do not subject the battery to extremely low air pressure, which may result in an explosion or the leakage of flammable liquid or gas.

Chapter 1 Product Overview

1.1 Rear Panel

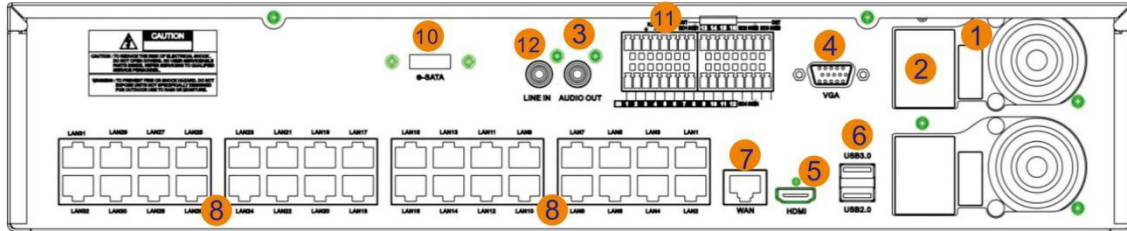
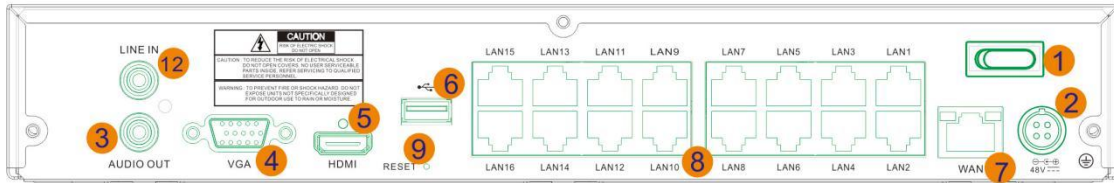

No.	Item	Description
1	Power Switch	Power switch to turn on or turn off the NVR.
2	DC Power Input	Connect the included DC power adapter
3	AUDIO Output	Audio output port. Connect to audio output devices like speakers.
4	VGA Port	Connect a VGA monitor. Audio line input port.
5	HDMI Port	Connect to HDMI display device(s).
6	USB Port	Connect an external storage device for recording or backup

6	Reset hole	Under the USB port, keep press 10 seconds to load device to default
7	WAN Port	Connect to a router or network switch
8	LAN Port	Network interface,connect IP cameras. <i>*It is strongly recommended to only one camera per PoE port.</i>
9	RESET Button	Press and hold for 10 seconds with a pin to restore default settings
10	E-SATA	Support E-SATA storage HDD to record and backup.
11	Sensor, Alarm &	SENSOR & G: Connect to external sensors;
12	Line in	Device intercom,microphone connect interface.

1.2 Remote control (Only for reference, subject to the physical object)

number	Keynote name	Key function
1	1-0	Channel selection, the number key
2	ALL	Multi-channel display
3	Menu	Enter the main menu / return
4	Mute	Silent function
5	Sub menu	Enter the sub menu
6	▲	Up button, volume adjustment
7	SEL	Select the key / Edit key, Confirm



		the selection operation
8	◀▶	Left / right, reduce / increase the parameter value on the control bar and adjust the volume on the playback page
9	▼	Down key, Volume adjustment
10	◀◀	Fast back key
11	▶▶	Fast forward key
12	▶	Enter the video query menu; play the key
13	●	Video key
14	■	Stop the manual video recording; stop the playing
15	⏸	Pause key / round tracking keys

Chapter 2 NVR Installation & Connection

This NVR supports two 3.5" or 2.5" SATA hard disk drives.

CAUTION: DO NOT install or remove the hard disk drive while the device power is turned ON.

HDD Installation:

a) Connect the data and power cables to the two hard disk drives and place the hard disk drives on

b) Carefully flip the NVR case and secure the hard disk drives to the NVR with the eight (8) screws

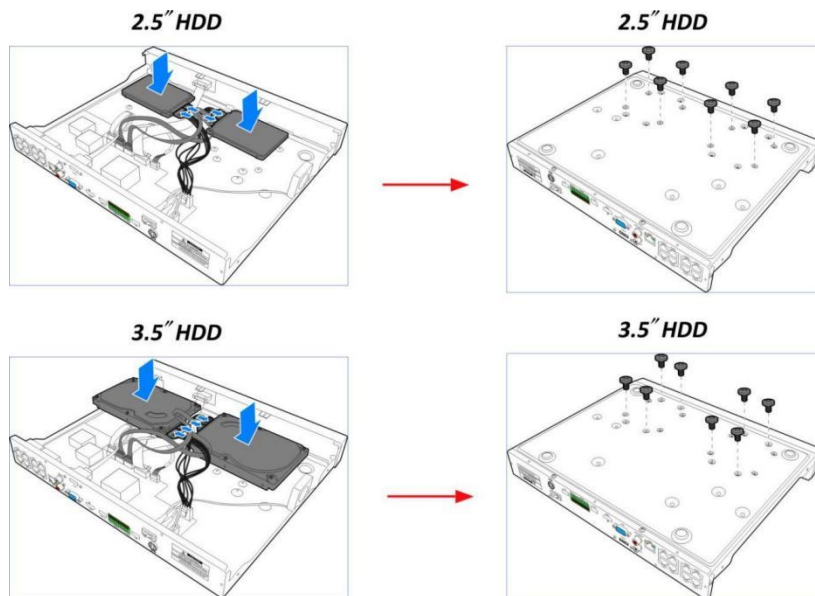

Note: Above procedures are for reference only. The practical operation may be different depending on the NVR you purchased.

2.2 Connection Diagram

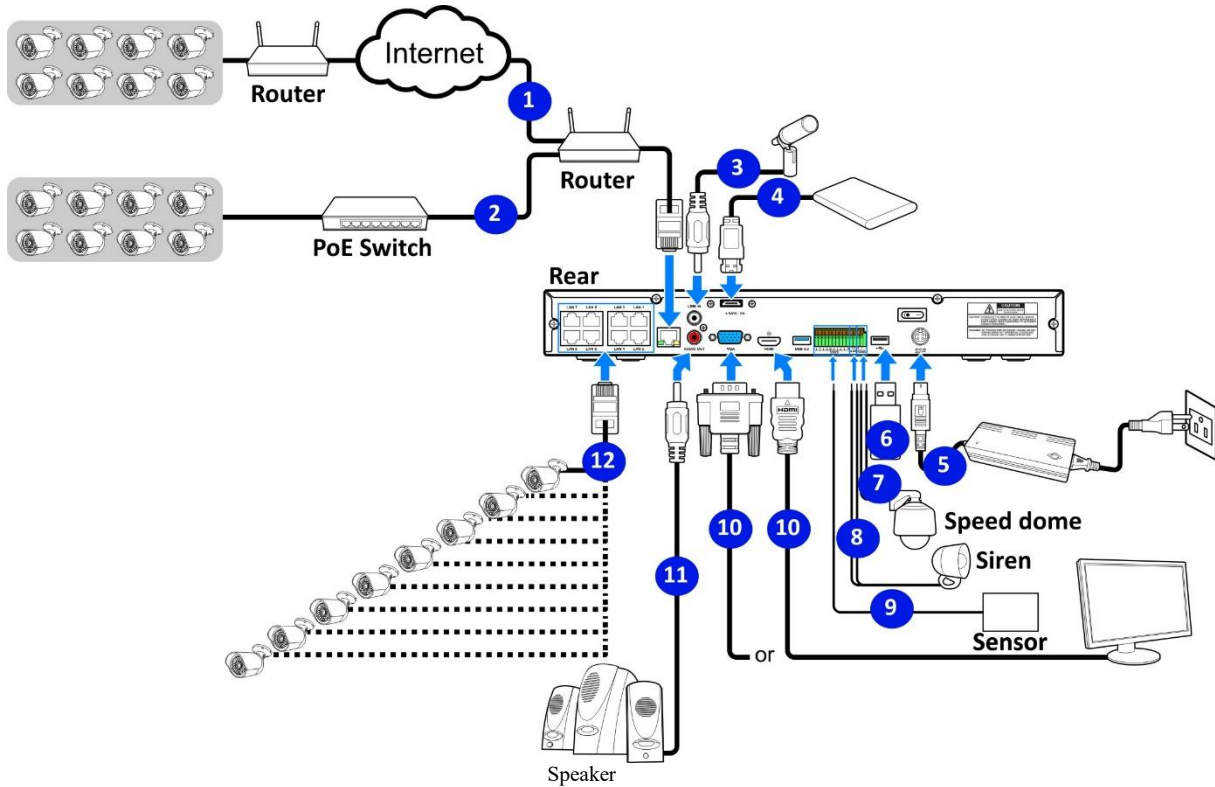

Note: Above diagram is for reference only. The practical connection may be different depending on the NVR you purchased.

2.3 Power Supply Connection

Caution: Use only the supplied power adapter that came with the NVR.

Connect one end of the power adapter to the power connector on the back of the NVR. Plug the other end of the power adapter into the wall outlet.

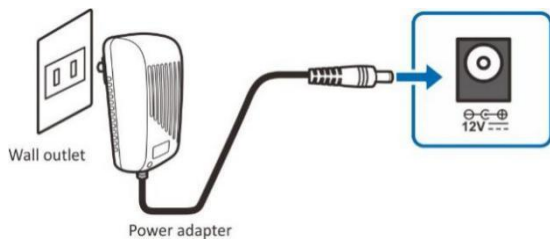

For some specific models, you may need to press the Power switch to turn on the power.

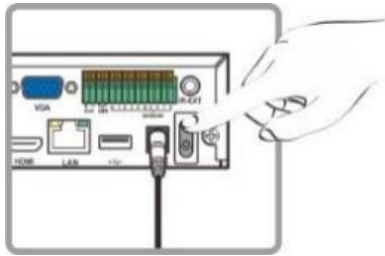

Chapter 3 Common operations of NVR

3.1 Use of the provided mouse

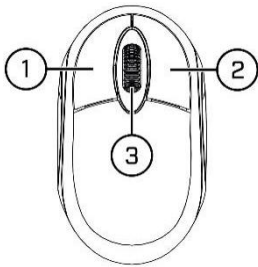

1. Left key

- Click to select the menu option
- In the multi-screen view, quickly double-click a channel for full-screen view.
Double-click the channel again to return to split-screen viewing.
- Select a channel in the Live preview to open the Camera Quick Toolbar
- Click and hold in preview mode to drag the slider and zoom

2. Right Button

- In menus, scroll to move up / down through the menu content.
- While hovering over the volume control wheel, scroll to turn system volume up / down.

3. Scroll Wheel

- In menus, scroll to move up / down through the menu content.
- While hovering over the volume control wheel, scroll to turn system volume up / down.

3.2 Using Virtual Keyboard

You will see the virtual keyboard automatically on the screen when you need to enter data, such as enter password, camera title, etc.

Click to toggle the keyboard to upper case

and more punctuations

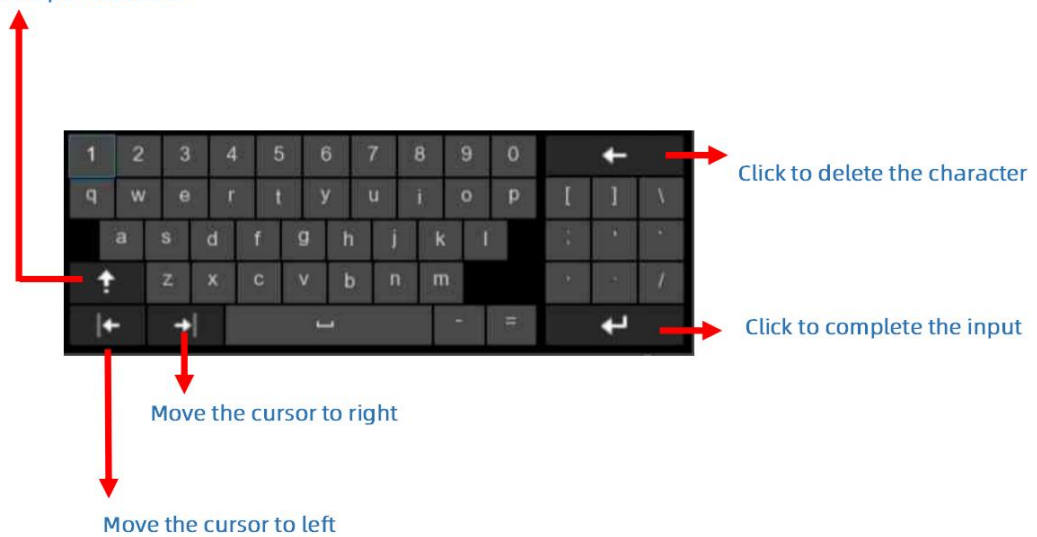

3.3 Password

For the first time when you run the recorder, you must be required to set your own password immediately in order to protect your privacy. Please be sure to record your username and password and save them in a secure place.

The screenshot displays a configuration menu with the following fields and options:

- Language:** A dropdown menu currently set to "English".
- Device ID:** A text input field containing "000000" with "(000000)" shown to its right.
- New Admin Name:** A text input field containing "admin".
- New Admin Password:** A password input field with a strength indicator bar showing red, yellow, and grey segments, labeled "Medium".
- Confirm Password:** A second password input field, currently highlighted with a blue border.
- Unlock Pattern:** A dropdown menu currently set to "Disable".
- Camera Activation Password:** A text input field with a checkbox labeled "Same as recorder's password" to its right.

An "Apply" button is located at the bottom center of the configuration area.

Language: Choose an available OSD language.

Device ID: Input the device ID in the parentheses. Default ID is 000000. If your device is not using a remote control, you can leave the default value.

New Admin Password: Set the administrator password. The password length should be between 8 and 16 characters and must include at least two combinations of uppercase letters, lowercase letters, numbers, or special characters.

Confirm Password: Re-enter the administrator password.

Unlock Pattern: You can enable Unlock Pattern for quick access to the system. Select "Enable" and then draw the pattern, confirm it twice, and the pattern password will be successfully set

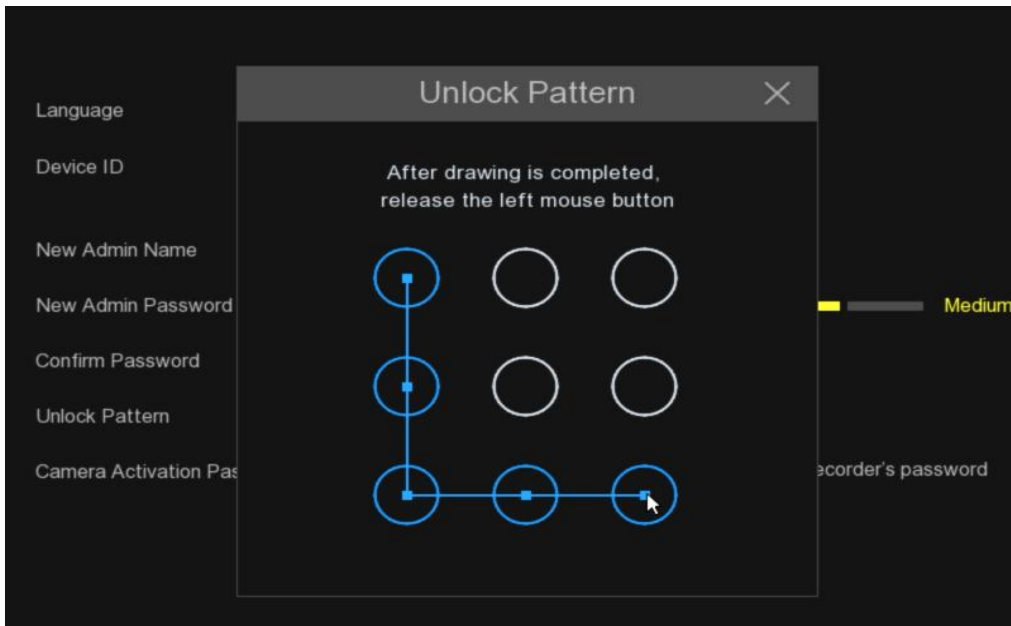

Camera Activation Password: This password is used to activate cameras that are not yet activated and are connected to the NVR. If "Same as recorder's password" is not checked, you can customize the activation password for cameras. If "Same as recorder's password" is checked, the device's login password will automatically be used as the camera activation password.

Click "Apply" to enter the password reset settings page.

Click [Apply](#) to enter the login interface, enter the device login password and click Login to unlock to enter the NVR system.

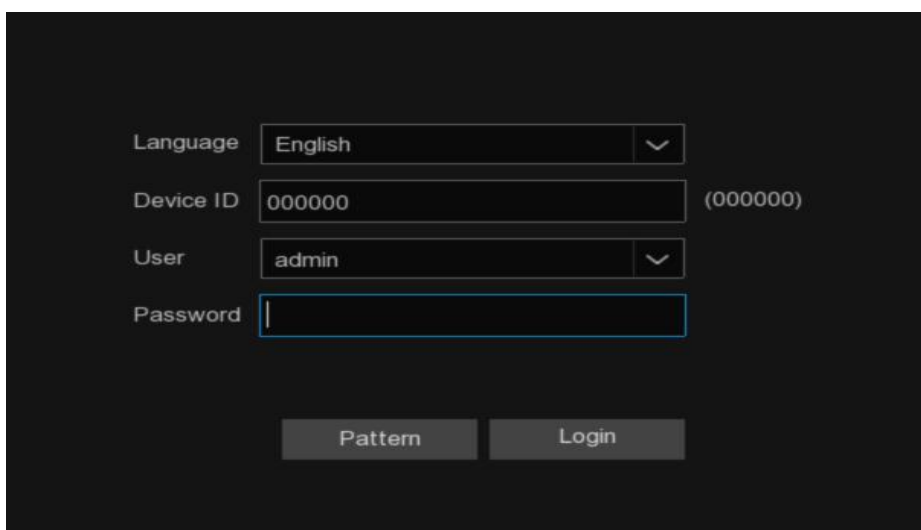

When the system is locked, click [Pattern](#) to enter the pattern password unlock interface to unlock the device.

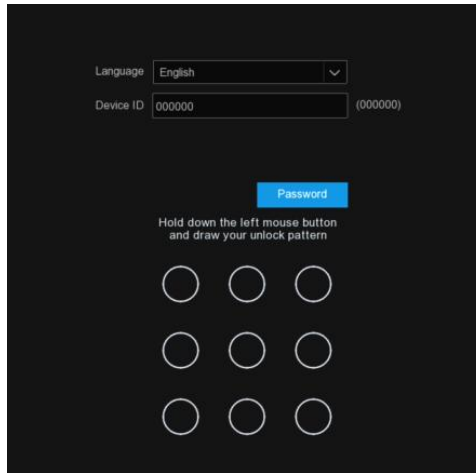

When the system is locked, if you forget the password, you can click [Forgot Password](#) to reset.

Note: Using the wrong password for 5 consecutive times, the system interface will be locked for 3 minutes.

After the first login, enter the password reset setting page, enable the appropriate password reset mode and save. If you click the Cancel button without checking any reset mode, the password reset function will not be enabled.

① **Security Questions** (checked)

Security Question 1: What is your father's middle name? (dropdown)
Answer: 1 (text box)

Security Question 2: What is your mother's maiden name? (dropdown)
Answer: 1 (text box)

Security Question 3: What's your head teacher's nickname in senior high school? (dropdown)
Answer: 1 (text box)

Password Reset Key (help icon) [Export]

Super Code (not recommended) (help icon)

[OK] [Cancel]

① **Security Question Configuration:** This feature enables the modification of the administrator user's password through security questions. After enabling it, you need to select three questions from a list of 15 common questions and set the answers, with a maximum length of 64 characters for each answer.

② **Certificate of authorization:** This feature allows the modification of the administrator user's password using a key. After enabling it, you need to click on "Export" to download the key file and certificate.txt to a USB flash drive.

③ **Super code (Not recommended):** This feature enables the modification of the administrator user's password using a super code. If you enable this recovery method, when you forget your password, you'll need to prepare the recorder's MAC address and the current system date, then contact the dealer from whom you purchased the device. They will provide you with a unique Super Code for your device.

3.4 System Login

Once the system password and password reset settings are completed, you can use the newly set password to log in to the recorder.

If you have enabled Unlock Pattern, you can draw the pattern you have set to quickly unlock the device.

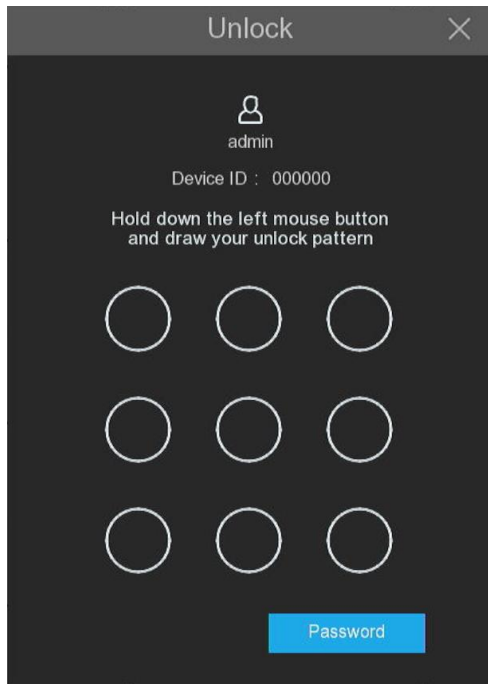

You can also click [Password](#) button to switch to the password input interface. After entering the password, click [Unlock](#) to access the device.

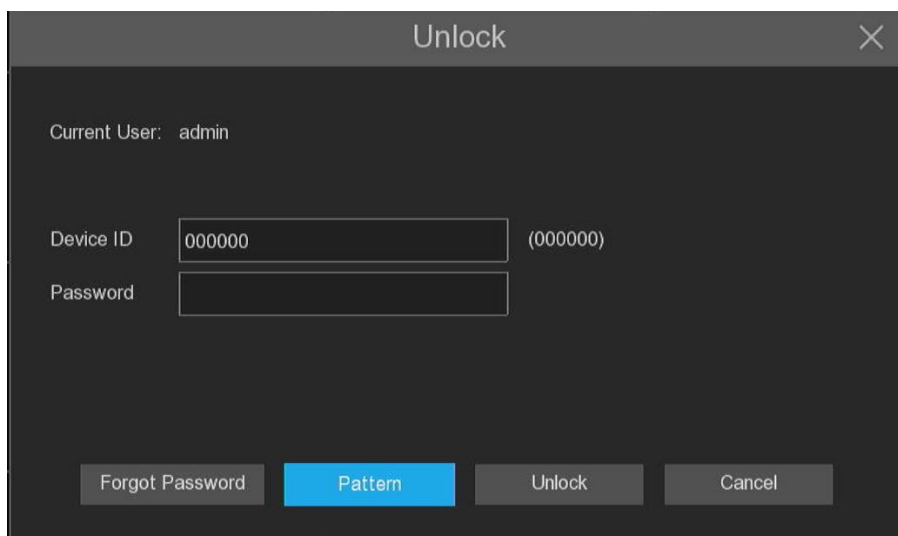

Note: The system interface will be locked for 3 minutes after 5 consecutive logins with incorrect passwords.

Chapter 4 NVR Starting up

4.1 Start Wizard

4.1.1 Start Wizard

When you first use the device, the system will open the Start Wizard menu, allowing you to quickly customize the basic functions of the device.

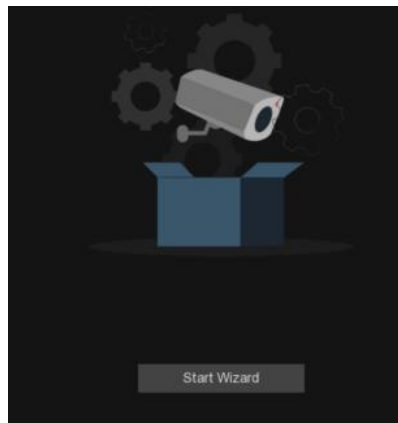

4.1.2 Network Configuration

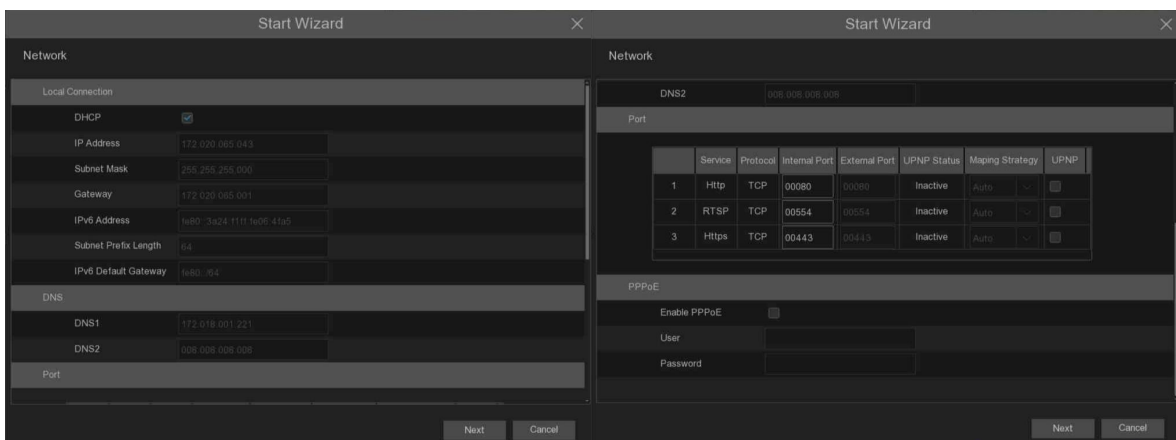

If the network connected to the device has a DHCP server, check the DHCP box, and the DHCP server will automatically assign all network parameters to the device. or manually set the following network parameters:

IP Address: IPV 4 address is the identity of NVR in the network. It consists of four sets of numbers between 0 and 255, separated by periods. For example, "192.168.001.100".

Subnet Mask: A subnet mask is a network parameter that defines the range of IPV 4 addresses that can be used in the network. Subnet addresses also consisted of four sets of numbers, separated by periods. For example, "255.255.000.000".

Gateway: The IPV4 gateway address of the network where the device is located, the default is 192.168.001.001.

IPv6 Address: The IPv6 address is the identity of the NVR in the network. It consists of eight sets of numbers between 0 and FFFF, separated by colons. For example, "ABCD:EF01:2345:6789: ABCD: EF01:2345:6789".

IPv6 Gateway: The IPV 6 gateway address of the network where the device is located.

DNS 1 / DNS 2: DNS 1 is the primary DNS server, and DNS 2 is the standby DNS server. Usually just enough to enter the DNS 1 server address.

Port

Web Port: This is the port used for the remote clients to log on to the NVR (for example, using the Web client). If the default port 80 is already occupied by another application, change it.

RTSP Port: This is the port where NVR is allowed to transfer live streams to other devices (for example, using a streaming player).

Https Port: Https port is the web browsing port, mainly for HTTPS services, is another HTTP that provides encryption and transmission through a secure port.

Note: WEB port, RTSP port and HTTPS port are integrated, and share one port, and the default is 80.

UPNP (Universal Plug and Play): Short for Universal Plug and Play, enables NAT traversal rules for automatic port mapping, allowing external computers to access internal network devices,

there by optimizing network efficiency. UPnP functionality requires router support. Before enabling UPnP, please configure the router and set parameters such as internal IP address, subnet mask, and gateway in the network basic configuration to match the router.. If your router does not support UPnP, make sure the port forwarding is completed manually in your router.

Mapping Strategy: Choose "Manual" for mapping type, allowing users to edit external ports (ports on the router). If set to "Auto," it will randomly map an external port (different from the internal port).

PPPoE: PPPoE is a protocol that allows the NVR to connect to the network directly through a DSL modem. Check the Enable PPPoE box, then enter the PPPoE username and password provided by the ISP.

Enable PPPOE: Enable/disable switch for PPPoE. When enabled, the NVR will restart to activate the PPPoE settings.

PPPOE Network Card Select: Select the LAN port corresponding to the dial-up connection. (Note: This option is not displayed in Single Address mode).

User: PPPoE user name.

Password: PPPoE password.

4.1.3 Date / time

This menu allows the user to configure the date, time, date format, time format, time zone, NTP, and Daylight Saving Time parameters.

Date and Time

Click on the calendar icon to set the current system date.

The screenshot shows a 'Start Wizard' window with a 'Date/Time' section. It has three tabs: 'Date and Time', 'NTP', and 'Daylight Saving Time'. The 'Date and Time' tab is active, showing the following fields:

Date	02/12/2025	
Time	10:59:52	
Date Format	MM/DD/YYYY	▼
Time Format	24Hour	▼
Time Zone	GMT	▼

At the bottom, there are three buttons: 'Previous', 'Next', and 'Cancel'.

Date: Click on the calendar  icon to set the system date.

Time: Click to set system time.

Date Format: Select the preferred date display format from the drop-down menu.

Time Format: Select Set the preferred time 24 hour or 12 hour display format from the drop-down menu.

Time Zone: Set the correct time zone for the area.

NTP

When this function is enabled, the device will automatically synchronize the date and time of the selected time server. In order to ensure the normal use of this function, the device should ensure the normal access to the network.

The screenshot shows the 'NTP' configuration screen. It has three tabs: 'Date and Time', 'NTP', and 'Daylight Saving Time'. The 'NTP' tab is active, showing the following fields:

Enable NTP	<input checked="" type="checkbox"/>
Server Address	pool.ntp.org ▼

At the bottom, there is an 'Update Now' button.

Tick the "NTP " box and select the NTP server.

Note: The default time zone is GMT. NTP is enabled by default, and the server address is pool.ntp.org

DST(daylight-saving time)

The screenshot shows the 'Start Wizard' interface with the 'Daylight Saving Time' section selected. The configuration is as follows:

Start Wizard					
Date/Time					
Date and Time	NTP	Daylight Saving Time			
Enable DST	<input checked="" type="checkbox"/>				
Time Offset	1Hour				
DST Mode	Week				
Start Time	Mar.	The 2nd	SUN	02:00:00	
End Time	Nov.	The 1st	SUN	02:00:00	

DST (daylight saving time): Tick to enable if Daylight Saving Time (DST) is observed in your region.

Time Offset (Time offset): Select the amount of time to offset for DST.

Time Mode (Daylight saving time mode): Choose to set the daylight-saving time in weeks or in days.

Start Time / End Time (Start time / end time): Set the start time and end time for daylight saving.

4.1.4 IP Camera

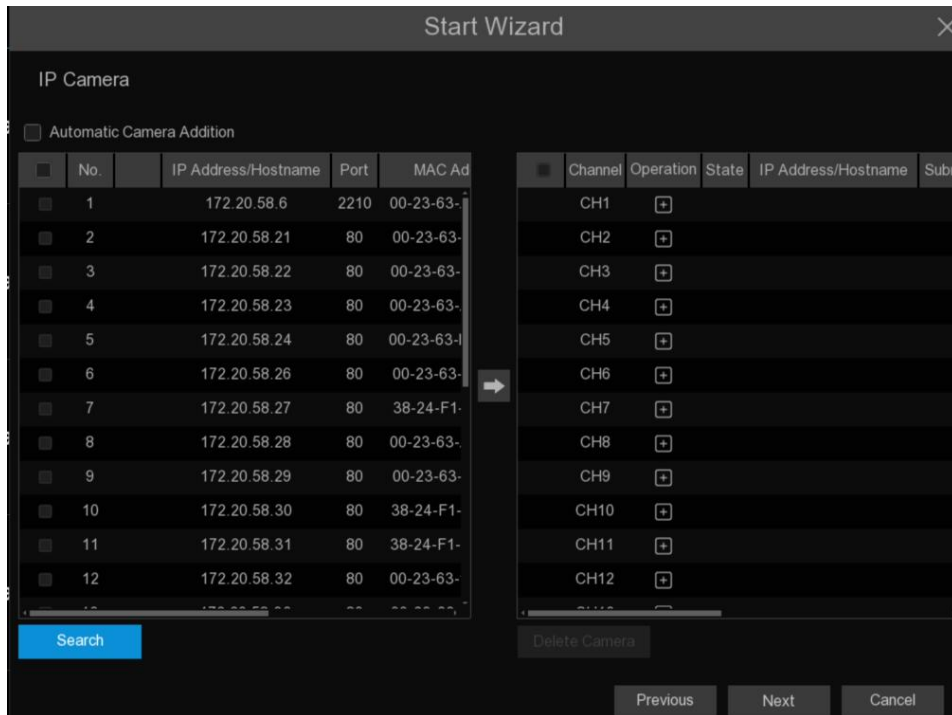

Click "Search" to search for IP cameras in the same network. Select multiple IP cameras you want to add and click the icon  Add to NVR. Enter the camera's user name and password to add the camera.

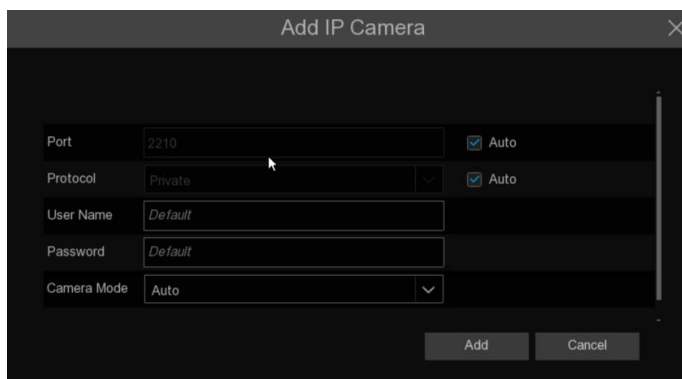

Enter the user name and password of the camera to add the camera.

Click  icon to open the IP Camera Add menu, manually enter the camera information or select the IP Camera from the device list.

No.	Edit	IP Address	Port	Activation State	Device Type	MAC Address
6		172.20.58.26	80	Activated	IPCamera	00-23-63-1
7		172.20.58.27	80	Activated	IPCamera	38-24-F1-1
8		172.20.58.28	80	Activated	IP CAMERA	00-23-63-1
9		172.20.58.29	80	Activated	IP CAMERA	00-23-63-1
10		172.20.58.30	80	Activated	IPCamera	38-24-F1-1
11		172.20.58.31	80	Activated	IPCamera	38-24-F1-1
12		172.20.58.32	80	Activated	30kq+200ai	00-23-63-1
13		172.20.58.33	80	Activated	IP CAMERA	00-23-63-1
14		172.20.58.34	80	Activated	30kq + 307	00-23-63-1

IP Address/Hostname:

Port:

Protocol:

Connection Mode:

User Name:

Password:

Connect with default password

Camera Mode:

Search Default Password Add Cancel

IP Address/Domain: IP address or domain name of the IP camera.

Alias: Name of the IP camera.

Port: The port of the IP camera.

Protocol: Select the protocol to be used for the add-in.

User Name: User name of the IP camera.

Password: Password of the IP camera.

Connect with default password: When checked, the camera connection will use the default password that has been set.

Channel Binding: Select to add the camera to a specified channel.

Camera Mode: Select the mode of the IP camera from the dropdown menu.

4.1.5 Disk

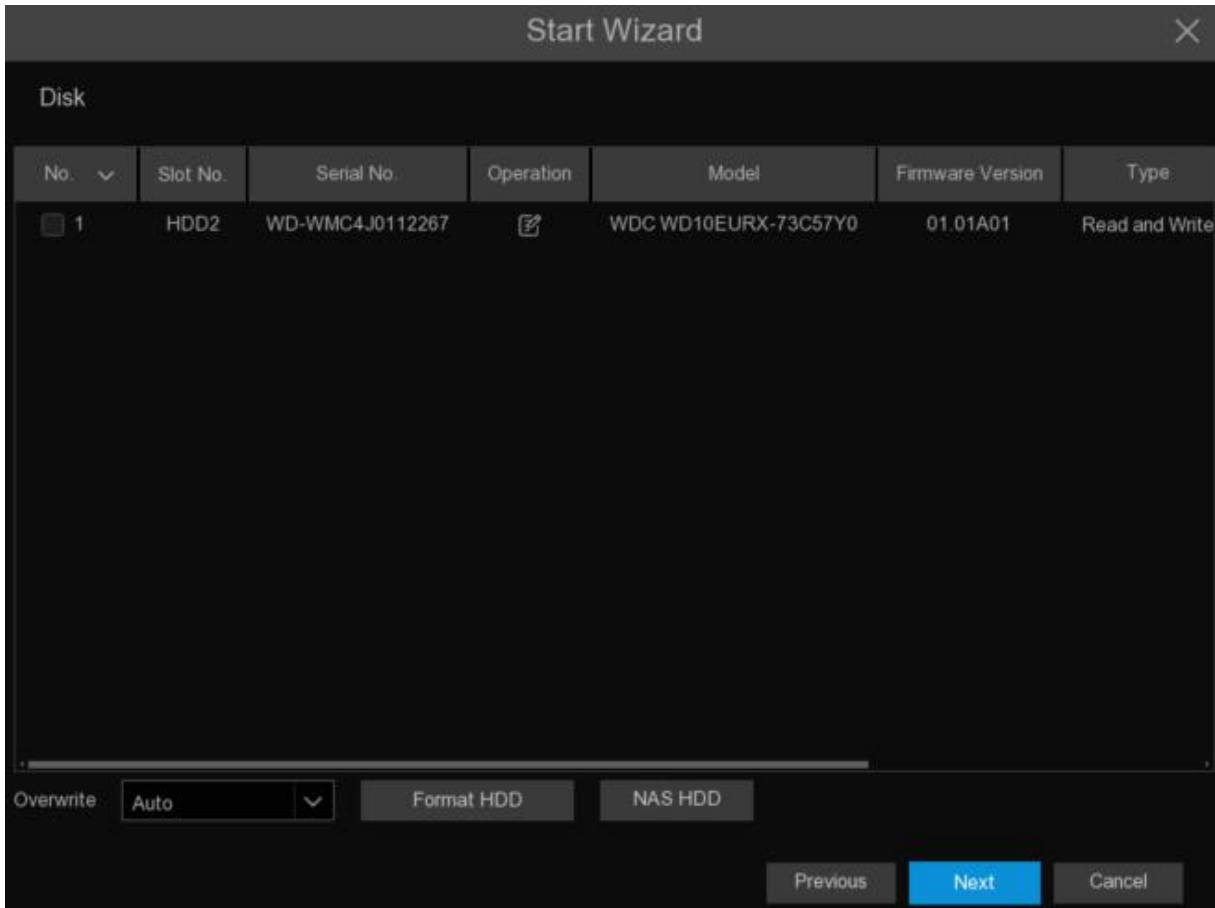

The drive needs to be formatted when it is first installed on NVR. Select the drive and click the Format HDD icon to format the drive.

Overwrite: When the hard drive is full, use this option to overwrite old records on the hard drive.

For example, if you select the 7-day option, only recordings from the past 7 days will be retained on the hard drive. To avoid overwriting old recordings, choose "Disable." If this feature is disabled, regularly check the hard drive status to ensure it is not full.

To prevent overwriting any old recordings, select **OFF**. If you have set Off on this feature, please check the HDD status regularly to make sure the HDD is not full. Recording will be stopped if HDD

is full. We recommended leaving the **Auto** selection as this prevents your NVR from running out of storage space.

Add NAS HDD: To add your NAS disk.

Record On E-SATA: If your NVR comes with an E-SATA port on the rear panel, you can enable to record the video to E-SATA HDD. This function only available when your E-SATA HDD has been connected to the NVR already.

4.1.6 Resolution

Choose an output resolution that matches your monitor. The NVR supports automatically adjusting the output resolution to match the optimal resolution of your monitor during startup. If you connect to a 4K HDMI monitor, you can select a maximum resolution of 4K (3840x2160). If you connect to a VGA monitor, do not select a resolution larger than 1080P (1920x1080).

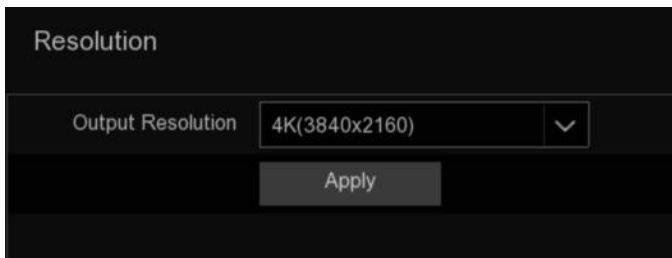

4.1.7 Mobile

When the device is connected to the Internet, users can scan the QR code through the mobile APP to realize the remote monitoring and management of the device.

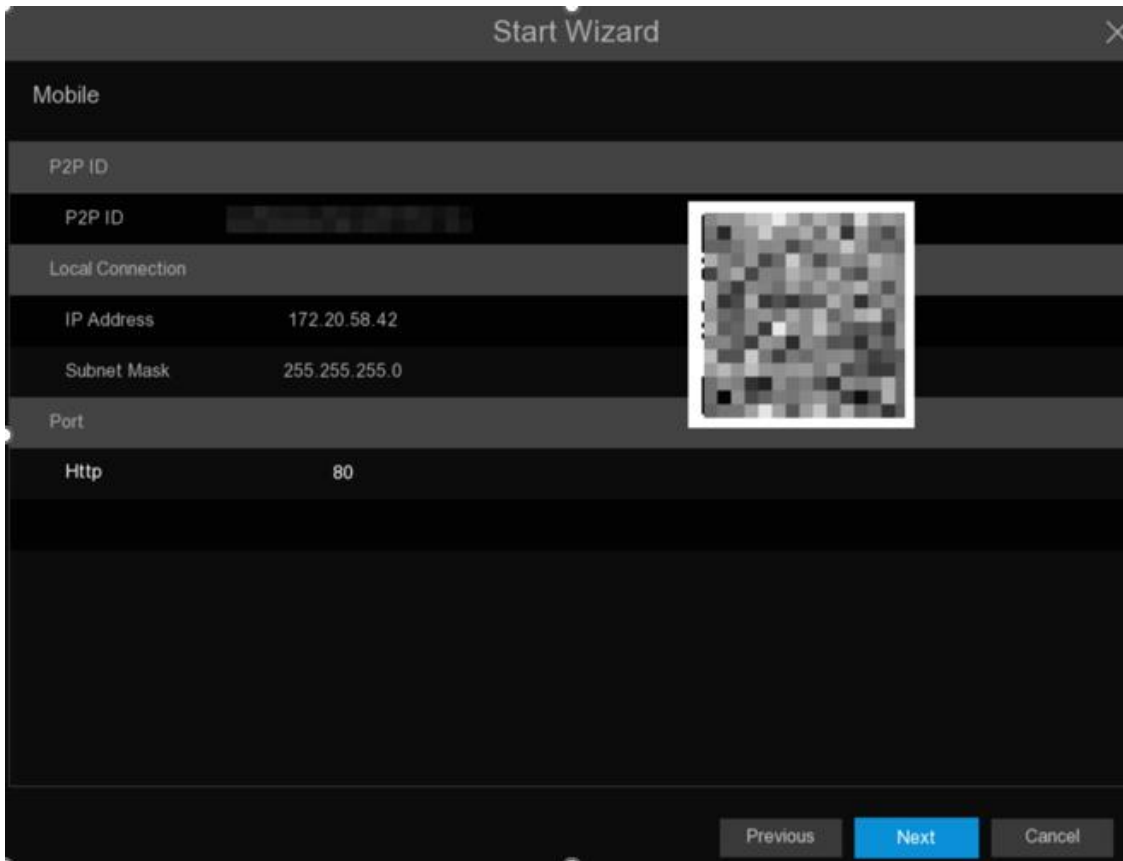

4.1.8 Summary

On this page, users can check the system summary information set up in the Start Wizard and complete the launch wizard.

If the user does not want to display the startup wizard on the next system restart, tick "[Don't show the start Wizard on next startup](#)" and click [Finish](#) icon to save and exit.

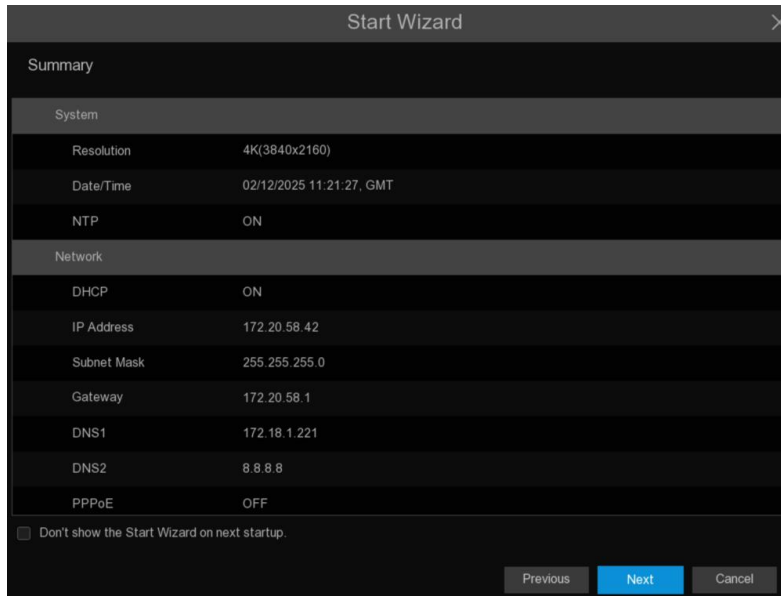

4.1.9 Cloud Service Configuration

By enabling the cloud service function, setting up the region, generating the dynamic QR code, using the CybVu APP to scan this QR code to add the device to the APP for management.

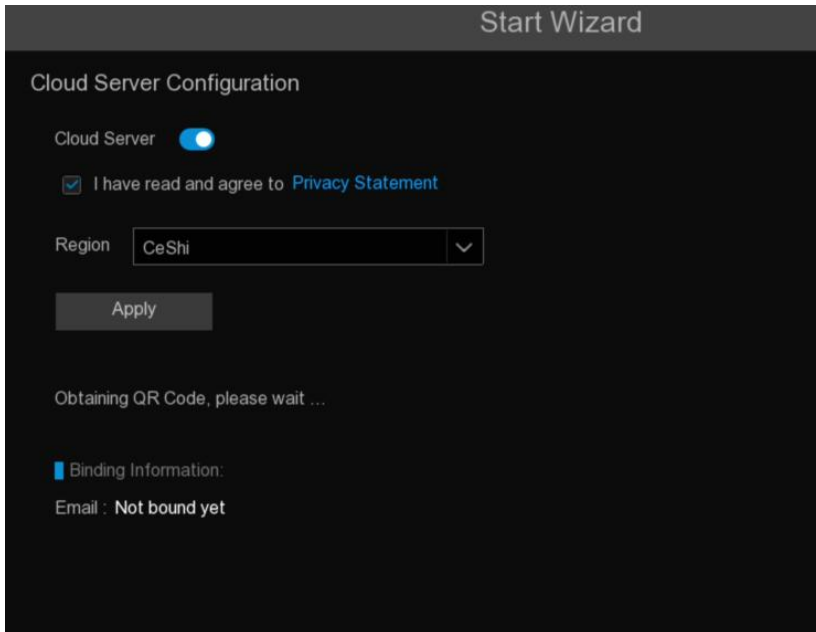

Cloud Services: Cloud Service Switch.

Privacy Statement: Enable cloud services, first read and agree to the privacy statement.

Region: Select the cloud service area (consistent with the CybVu APP registration area).





QR code display: After enabling cloud service and setting the area, dynamic QR code will be automatically generated (The valid duration of the QR code is 300s, failure automatically after expiration, you need to re-obtain). Scan the QR codes using the CybvU APP, the camera can be added to the APP for management.

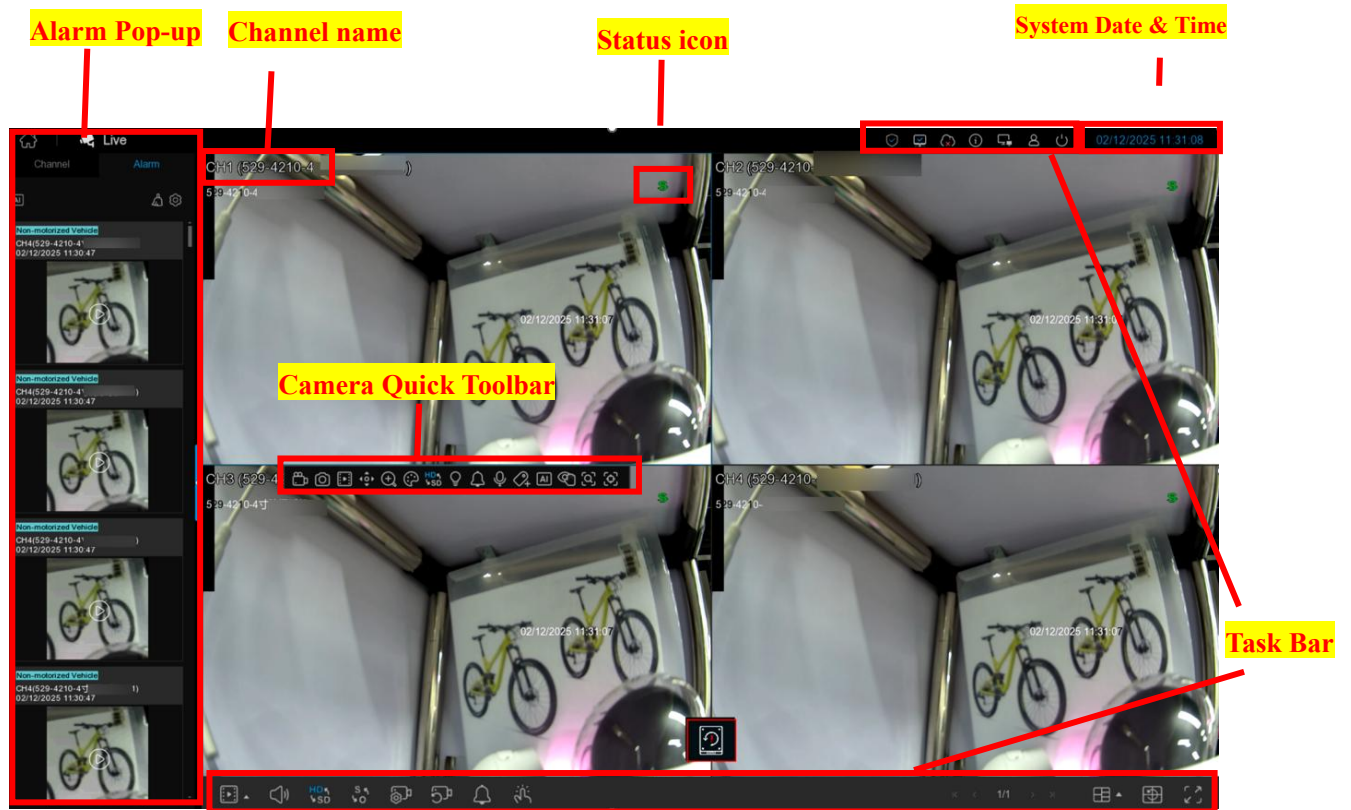

Unbind: Click the unbinding button, users can unbind the camera with the CybvU APP account. After unbinding, the device on the APP is prompted offline and inaccessible.

Note: The cloud service function needs to communicate with the cloud server, so the device needs to be connected to the Internet when using this function.

4.2 Introduction of the real-time view interface



Status Icons	
Icon	Description
	The camera is being recorded currently
	A motion alarm is happening
	An intelligent or AI alarm is happening
	The external I/O alarm device is being triggered

HDD Error Icons	
Icon	Description
	HDD is uninstalled or in error
	HDD is unformatted



The other prompt messages that may appear in the screen:

Off-line: The analog camera is disconnected.

No Camera: No camera has been added to the channel.

Decoding Failed: NVR does not support this IP camera compression standard, please change to H.264 compression standard.

Insufficient Resource: The decoding resources for previewing IP channels exceed the decoding specifications limit, or IP channels using MJPEG encoding type can only preview one IP channel, while other IP channels indicate insufficient resources.

Insufficient Bandwidth: Insufficient bandwidth, channel cannot be brought online.

Failed to connect to camera: Failed to establish connection with the IP camera.

Incorrect user name or password: The username or password for the IP camera is incorrect.

Please enter the correct username and password.

Privacy Mode: The IP camera is enabled in the privacy mode.



Click to open the Quick Add menu to add an IP camera.













Click to edit the current channel parameters.







4.2.1 Camera Quick Toolbar

In live viewing, click the left button of your mouse on a connected camera to display the camera quick toolbar.

Note: The shortcut buttons that appear may vary depending on the camera model.



Icon	Function	Description
	Manul Record	Click to manually record the channel immediately. If the manually recording is in process, the icon will be in red color. Click one more time to stop manual record.
	Image Capture	Click to save a snapshot of the current camera image. Manual Capture must be enabled to use this feature. For details on enabling Manual Capture.
	Instant Playback	Click to play the latest 5 minutes recording of this channel
	PTZ Control	Click to enter PTZ control panel, click to control zoom and focus of motorized varifocal lens
	Digital Zoom	Click to zoom-in the channel. Scroll the wheel button of your mouse to zoom in and zoom out the image.
	Color Adjustment	Click to adjust the image color of the channel.
	Stream Switch	To switch the live view video stream between HD & SD. HD is mainstream images, SD is substream images.
	Siren Switch	If your camera has a built-in speaker, click this button to turn on or turn off the alarm sound.
	White light	If your camera has white light LEDs, click this button to turn on or turn off the LEDs.
	Warning light	If your camera has warning light LEDs, click this button to turn on or turn off the LEDs.

	Intercom	Click to start two-way voice communication.
	Tag button	It supports to fast search by adding a tag in live view. Tagging enables you to create a searchable, descriptive index of important events or points of interest within extensive video recordings.
	AI statistics	Hover the mouse upon the icon to view AI statistics when the AI function is activated in your NVR.
	Privacy mode	While enabled or disabled privacy mode, during privacy mode enabled, preview and playback without images.
	In pick	This button is displayed when the camera is connected, and click the button to enter In-Pick mode (some cameras do not support In-Pick function, only some NVR models support In-Pick)
	Area focus	Click the button, use the mouse to preview the area. The camera lens will focus according to the sliding area.(Zoom camera support only)
	Fisheye Mode	When a fisheye camera is connected, this button will appear. Clicking the button will enter fisheye mode preview. (Only certain NVR models support local operation of fisheye mode.)

4.2.1.1 In-Pick

After the device adds camera online, the In-Pick icon will be displayed in the preview channel

shortcut  and the playback operation menu. Click the button to enter the In-Pick mode setting page.



The preview/playback is paused, the system will automatically detect and identify and select the

human type and model targets in the screen, click  button to enter the In-Pick search page, automatically retrieve the screenshots stored

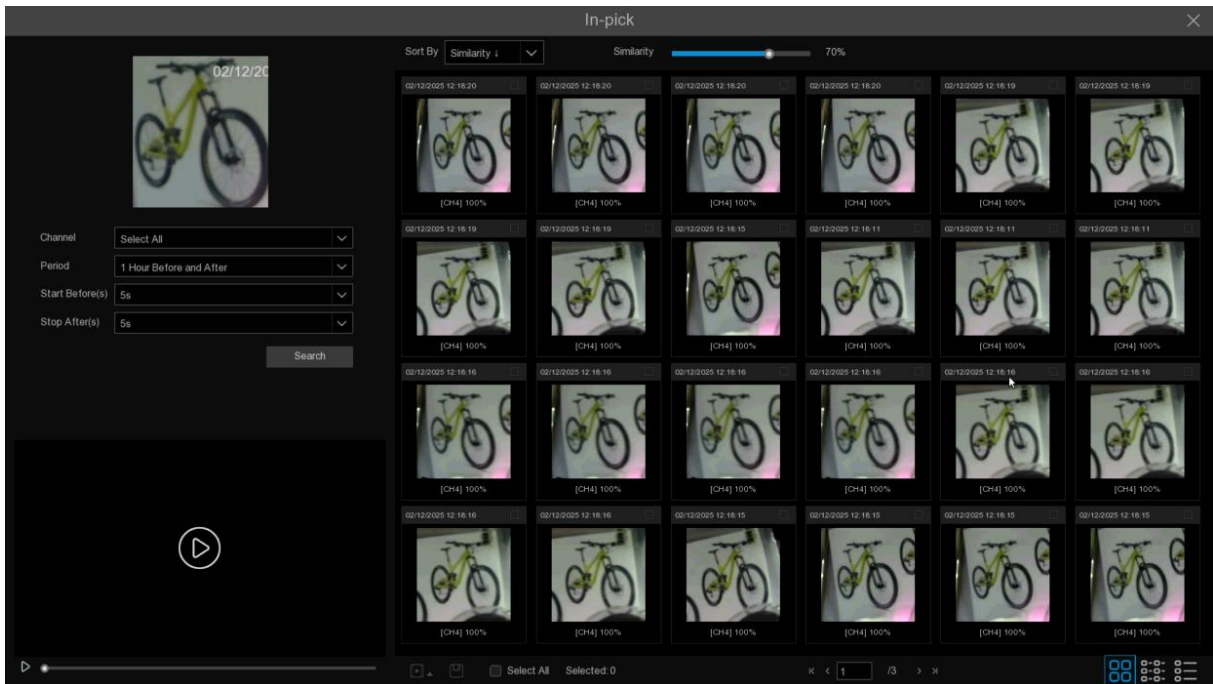

in Pedestrian and Vehicle according to the screenshots selected in the AI playback, and show the search results of similarity match.

1. **Search criteria:** Show the search results according to the set conditions.

Channel: Select the channel need to be searched.

Period: Select the search period, the options include one hour before and after, today, two days before and after, seven days before and after, and user customization. For example, one hour before and after the selection, the entry search time is 19:00, so the search period is 18:00-20:00.

Start Before, Stop After: Select the time before and after playback, for example, select 5s and 60s respectively, the search results will start the playback 5s before the actual start time, and the playback will end 60s after the actual end time.

Sort By: Select the sorting method, you can select the time lifting order and the similarity lifting order to sort the search results.

Similarity: Select the similarity and search according to the set similarity.

Search: Start to search.

Search results presentation:

Sort By: Select the sorting method, you can select the time lifting order and the similarity lifting order to sort the search results.



Thumbnail view: You can view the snapshots of the results.



List view: The search results are displayed in the list.



Details View: You can view the details of the search results.



: You can switch to the pages to view the results.

2. **Playback and backup of search results:** Click the snapshot and put it back in a small window.

double-click the snapshot to enter the playback page, which is consistent with the system playback function (see Chapter 7 Search, Playback and Backup for specific functions).



: Playback and backup, click to enter the playback and backup.

4.2.1.2 Fisheye mode

After the fisheye camera is added to the device, the fisheye menu will display in the preview channel operation menu and the playback operation menu of the preview channel. Click  button to enter the fisheye mode setting page.



On the fisheye mode operation page, click  bottom toolbar button to enter the setting menu of fisheye camera installation mode, select the corresponding mode according to the actual installation mode, and take effect after saving.

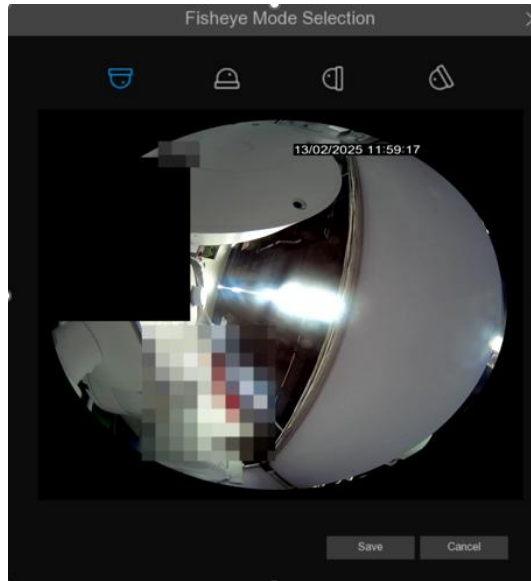

After setting the corresponding fisheye installation mode, the viewing mode type supported in the selected installation mode can be displayed in the bottom toolbar. Various modes can be switched according to the viewing needs, and drag and drop the picture and zoom the mouse wheel.



4.2.2 Taskbar



Click  button to select a different layout to preview different channels.

Common layout: You can select the regular layout split screen provided by the system (2,4,6,8...

split screen)

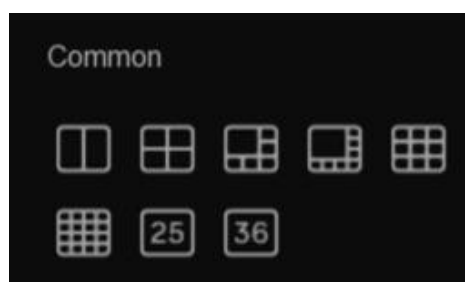

Custom View Settings: Click  to enter the setting page to customize view settings.

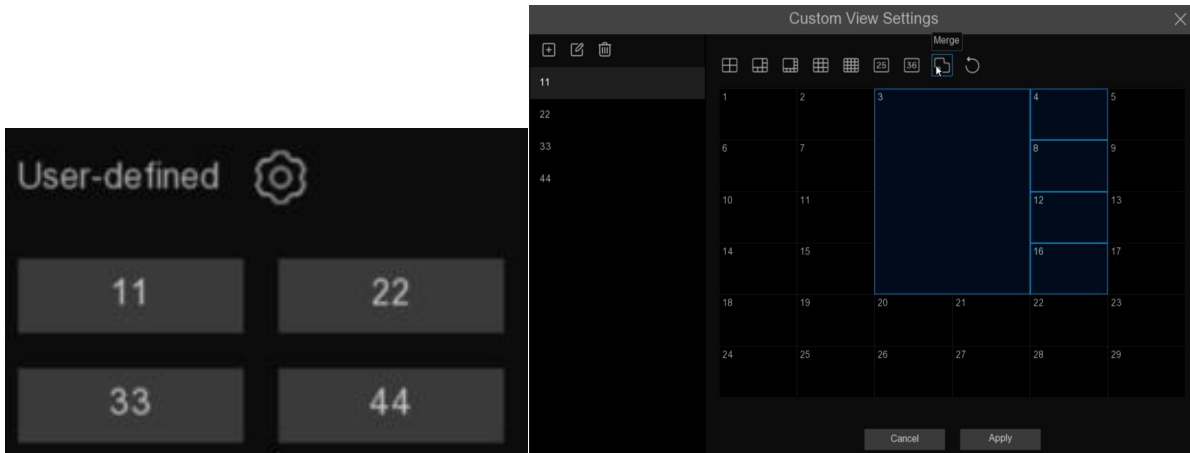

On the setup page, the functions are as follows.

Add a custom layout, click  add a new custom layout, enter the name and click **Apply**, the custom layout is added successfully.

Edit the custom layout name, and click  to set custom layout name.

 Delete the custom layout.

Click  to select the rule split screen as the custom layout.

Merge, use the mouse slide to select a small window, click , you can combine the selected window into a large window

Cancel, after the merged window, click  button to cancel the merged window and change it back to the original small window.

Auto Cycle: Click  to start preview the channel in sequence.

Quick playback, playback the video of all channels from the beginning of the day, you can also click  the lower right triangle to select from the last 5s, 10s, 30s, 1Min, 5Min to start playing.

Click  to adjust the volume.

Click  to switch all IP channels to main or substreams for a preview.

Click  to switch between the original scale screen or the stretch screen.

Click  to switch between balanced or smooth views. Preview mode affects preview video quality only through bit and frame rates, but does not affect recording quality.



There is not connection network.



There is the network disconnection.



The network connection was successful.



Enable or disable the white light and alarms for all channels.



Start or stop manual video recording and manual alarms.



View system information, channel information, recording information and network status.



One-click restore of the channel location under the multi-split screen preview.



NVR is not enabled the cloud services.



NVR is enabled the cloud services.



The NVR is in arming state.



The NVR is in disarming state.



The combined alarm message popup is displayed only after the combined alarm is triggered.



WiFi external drive device, click to remove the device safely, to avoid possible system abnormalities caused by direct removal.



Click the button, the mouse can switch between the main screen and the auxiliary screen (Supported on some NVR models).

4.2.3 System Menu

In the system page, click the right mouse button to call up the system menu. Through the system menu, you can switch to the corresponding system page, including Live, Playback, Search, AI Scenario, and Configuration.

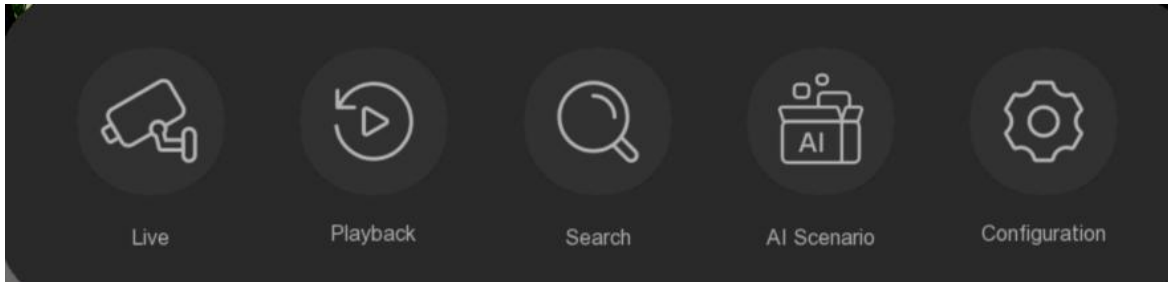

Live: Preview, view the access camera preview situation

Playback: Video playback, including regular playback, slice playback, slice playback, and external file playback

Search: Search for playback, including event playback, picture playback, tag playback and AI playback.

AI Scenario: AI scenario-based application.

Configuration: Each setting of the NVR system.

4.2.3.1 Unlock and Lock Screen

When the NVR does not operate for some time(default 1 min), the screen will be locked to protect the system security.

In the unlocked state, click  the taskbar to call the menu.

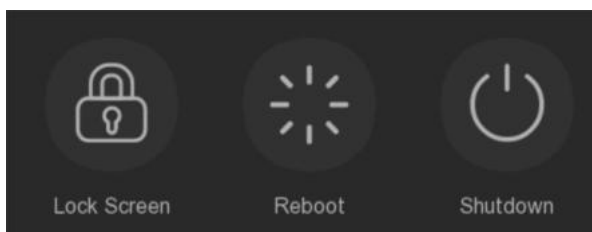

Click  [Lock Screen](#) icon to lock the system immediately.

If the system is locked, then click the right mouse button to call up the menu, and you can pop up the unlock window to unlock.

4.2.3.2 Shutdown and Reboot

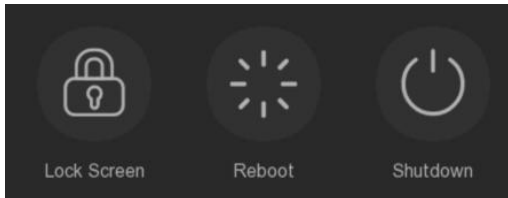

Click the [Shutdown](#) button in the menu and select the action to take. Click the [Authenticate](#) button, the system will popup and enter the administrator password for authentication.

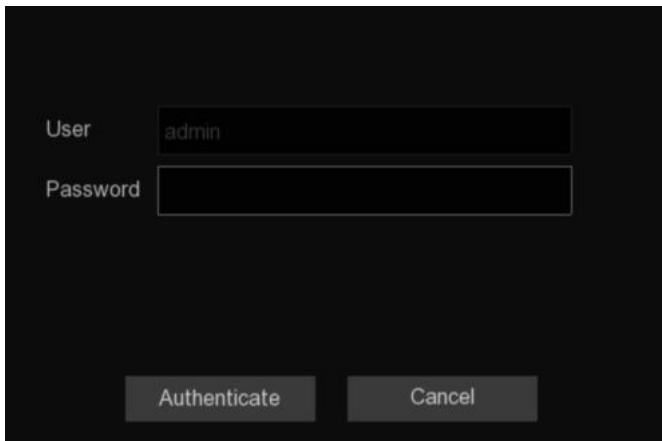
A dark-themed authentication dialog box. It has two input fields: 'User' with 'admin' entered, and 'Password' which is empty. Below the fields are two buttons: 'Authenticate' and 'Cancel'.

Select [Reboot](#) System , and the system will restart after entering the password.

4.2.3.3 Switch User

Click  in the taskbar, you can call up the user switch menu, select the user who needs to log in, enter the corresponding user password, click [Switch User](#), the system will switch the user.

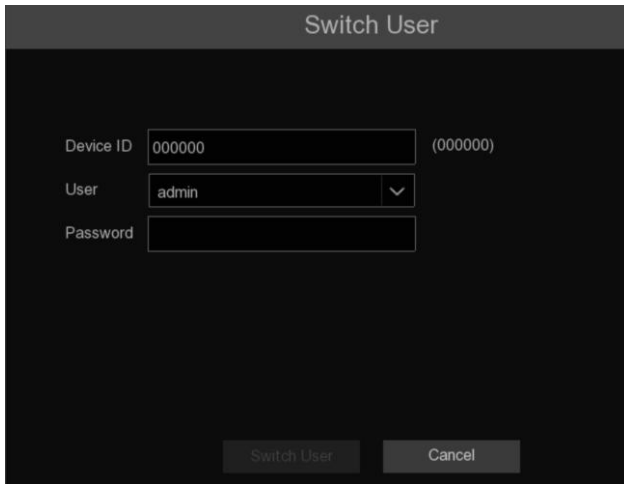

The image shows a 'Switch User' dialog box with a dark background. At the top, the title 'Switch User' is displayed. Below the title, there are three input fields: 'Device ID' with the value '000000' and a small '(000000)' label to its right; 'User' with a dropdown menu showing 'admin'; and 'Password' with an empty text box. At the bottom of the dialog, there are two buttons: 'Switch User' and 'Cancel'.

Chapter 5 NVR system Settings

This menu can be configured with channel, record, event, network and other parameters.

Path: [System menu->Configuration](#).



5.1 Channel

In this section, the user can configure the camera, real-time preview, manage IP camera, adjust the image of the IP camera, PTZ settings, motion detection settings, etc.

5.1.1 Channel

5.1.1.1 IP Channels

Channel	Operation	State	IP Address	Port	Device Type	Protocol	MAC Address	Software Version	Manufacturer
CH4 (529-4210)			172.20.58.46	80	IP CAMERA	Private	00-23-63-B3-AA-5F	VC43.45.1.2.0-250121	
CH5									
CH6			172.20.58.30	80	IPCamera	Private	38-24-F1-04-E0-2F	VC21.45.1.2.0-250123	
CH7									
CH8									

No.	Edit	IP Address	Port	Channel Count	State	Device Type	Protocol	MAC Address	Software Version	Manufacturer
6		172.20.58.26	80	1	Activated	IPCamera	Private	00-23-63-B3-79-80	VC30.85.1.1.0_240910	
7		172.20.58.27	80	1	Activated	IPCamera	Private	38-24-F1-06-04-09	VC48.55.1.1.1_240926	
8		172.20.58.28	80	1	Activated	IP CAMERA	Private	00-23-63-AD-3F-50	VC30.85.1.1.0_240910	
9		172.20.58.29	80	1	Activated	IP CAMERA	Private	00-23-63-90-11-7C	V31.35.8.2.2_220625	
10		172.20.58.31	80	1	Activated	IPCamera	Private	38-24-F1-04-DF-C6	VC21.45.1.1.0_240827	
11		172.20.58.32	80	1	Activated	30kq+200ai	Private	00-23-63-94-A9-DE	VC31.35.1.1.0_240910	
12		172.20.58.33	80	1	Activated	IP CAMERA	Private	00-23-63-AC-B7-86	VC31.35.1.1.0_240910	
13		172.20.58.34	80	1	Activated	30kq + 307	Private	00-23-63-9E-78-EF	VC31.35.1.1.0_240910	
14		172.20.58.35	80	1	Activated	SSC30KQ+SC500A	Private	00-23-63-92-CF-8D	VC31.35.1.1.0_240910	
15		172.20.58.36	80	1	Activated	SSC30KQ+IMX307	Private	00-23-63-AE-0F-E7	VC31.35.1.1.0_240910	
16		172.20.58.37	80	1	Activated	IP CAMERA	Private	00-23-63-A0-73-0F	VC42.54.1.2.0-241129	

1. Click [Add](#) to realize the expansion and folding of the device search window
 - a. Click [Search](#) button to search and display the devices under the same LAN. Select one or more devices based on the search results, and click [Add](#) to input the corresponding information to complete the addition.
 - b. Multiple devices can be selected based on the search results. Click [Batch IP Modification](#) to set the correct information and modify the selected camera IP in batches.
 - c. Select [Automatic Camera Addition](#), the device will automatically add the camera that is not added in the LAN to the channel

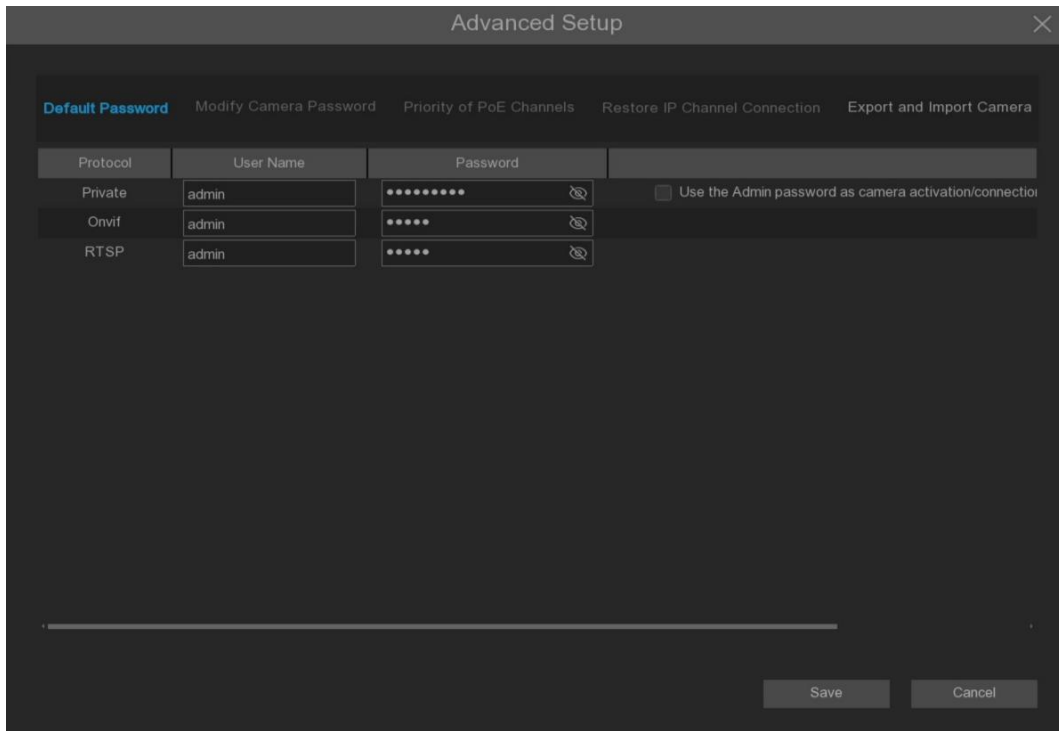

2. Click [Advanced Setup](#) button to enter the password of the device to open the Advanced Settings page, where the following operations can be performed.

a. Default Password: Set the default password for the device to connect the camera through Private / Onvif / Rtsn protocol. The default password of Private protocol can be used to activate the unactivated camera. When Use the Admin password as camera activation / connection password is checked, Private protocol will activate / connect the connected camera using the device administrator password.

b. Modify Camera Password: Change the password of the existing online camera.

c. Priority of PoE Channels (POE model NVR support only).

(1). The POE channel is preferred. If the camera has been manually added to the channel, then the camera is connected to the PoE port corresponding to the channel, the original manually added camera will be replaced by the PoE access camera.(Not checked to remember my choice, only effective once)

(2). Manual addition is preferred. If the camera has been manually added to the channel, and then the camera is connected to the PoE port corresponding to the channel, the camera originally added manually will not be replaced by the camera connected to the PoE access.(Not checked to remember my choice, only effective once)

(3). If any priority is not enabled, when the channel has been manually added a camera, access the camera in the PoE port corresponding to the channel, and the popup indicates that the current channel has exists and ask whether to replace it.

d. Restore IP Channel Connection: When the device mistakenly removes online channel due to the restoration of factory settings, it can add the original online camera back to all the channels with one key.

Note: This function does not take effect after the factory Settings are restored via **Factory**

Defaults.

e. Export and Import Camera: Export added IPC information as backup for reimport or import into other devices (exported information does not include connection password).

3. Select the camera that has been added to the device, and click **Delete** button to delete the selected camera.

4. Tick **Show Password**, enter the administrator password and display the camera connection password added to the device.

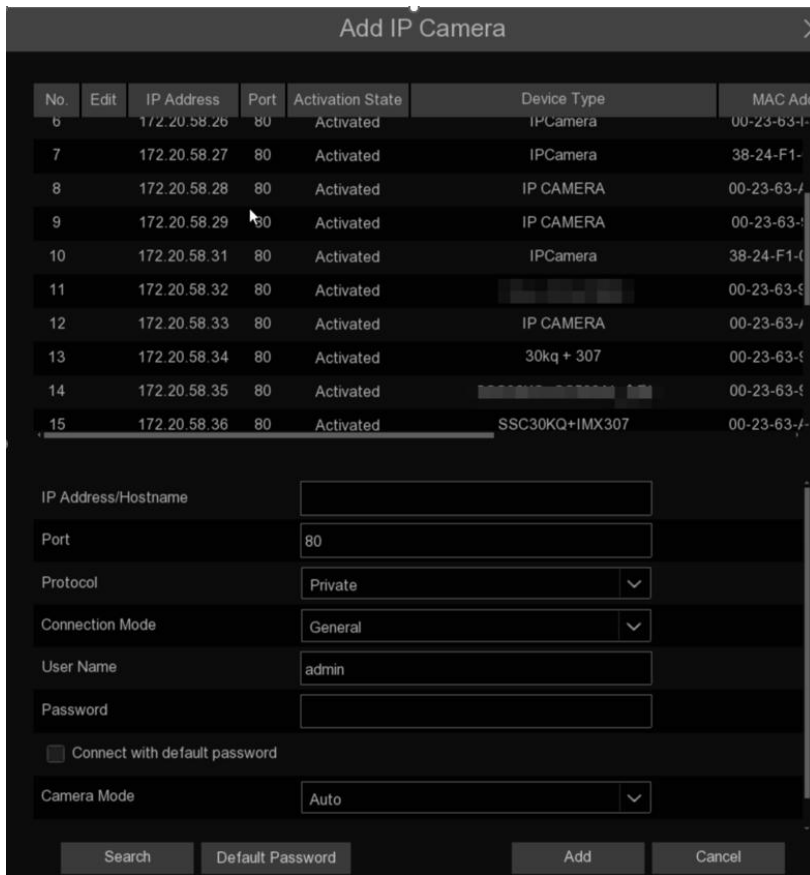

Click [Search](#) icon to search for the online camera in the LAN, select the camera to be added, and enter the correct information to add it.

Protocol: Select the protocol of the IP camera from the drop-down menu, including Private, Onvif and RTSP protocol.

The screenshot shows the 'Edit Connection Information' dialog box. The fields and their values are as follows:

Field	Value
Channel	CH5 (111112222233333444455555666667)
IP Address/Hostname	10.10.5.5
Subnet Mask	255.255.000.000
Port	80
Protocol	Private
Connection Mode	General
User Name	admin
Password	••••••••
Mode	Auto
Camera Mode	Auto

Buttons: OK, Cancel

Connect Mode: Select General or Security from the drop-down menu. Choosing General will use the HTTP port connection protocol. Select **Security** will use the HTTPS port connection protocol.

Note: If the camera does not support using the Hhttps mode, the HTTP port will be automatically switched.

Mainstream URL: When you select the RTSP protocol, this option appears, so enter the main stream address to connect to the IPC.

Substream URL: When you select the RTSP protocol, this item appears, enter the substream address to connect to the IPC.

The screenshot shows a configuration window titled "Edit Connection Information". The fields are as follows:

Field	Value
Channel	CH5 (1111122222333334444455555666667)
IP Address/Hostname	10.10.5.5
Subnet Mask	255.255.000.000
Port	80
Protocol	Private
Connection Mode	General
User Name	admin
Password	••••••••
Mode	Auto
Camera Mode	Auto

Buttons: OK, Cancel

Click **Mode** drop-down box to select either **Auto** mode or **ePoE** mode.

Note: In automatic mode, the transmission bandwidth of 100Mbps supports the maximum transmission distance of about 120 meters. In ePoE mode, it limits the transmission bandwidth to 10Mbps to expand the transmission distance to about 230 meters.(To ensure transmission stability, the Cat5E or Cat6 network cable is recommended)

Camera Mode: Camera mode, support Auto, Normal, Fisheye three modes.

5.1.1.2 POE power

This interface can display the power used by IPC to access NVR through PoE, and can view the used PoE used power and remaining power of NVR in real time.

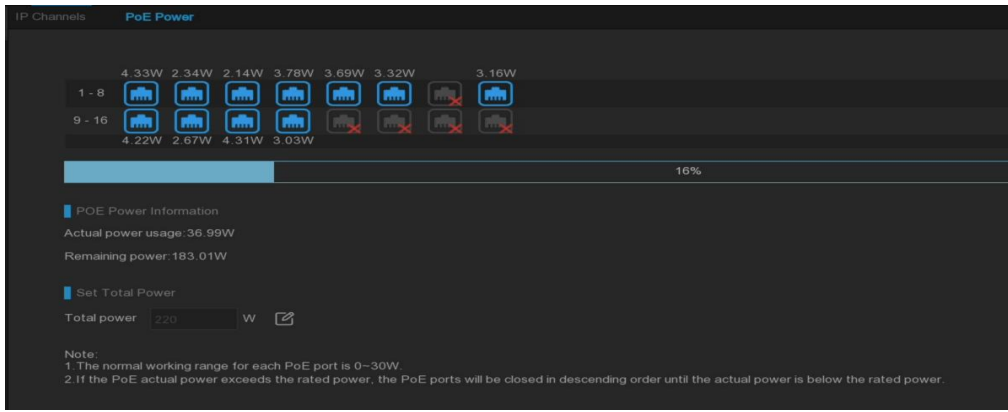

Actual power usage: PoE Power in used.

Remaining power usage: Remaining PoE power.

Total Power: Set total power, click  button, pop up the prompt box, then can be set to modify the total power.

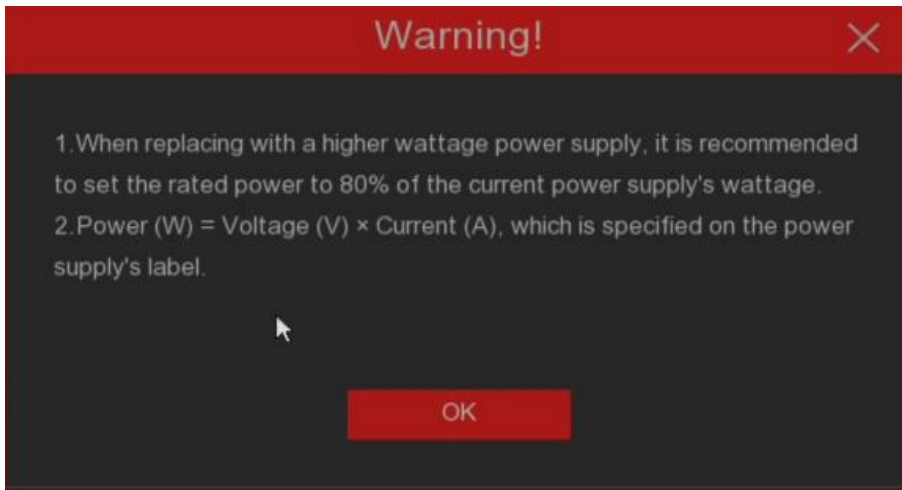

Warning:

1. If larger power supply is replaced, it is recommended to set the remaining power to 80% of the current power supply to ensure that the power supply load is within a reasonable range.

2. The power calculation formula is: power (W) = voltage (V) *current (A). For specific parameters of the power supply can refer to the annotation information on the power supply sticker

Note:

1. Single PoE port can support maximum power output of 30W.
2. If the output power of the connected device exceeds POE port, the power supply will be insufficient and the upper and camera will offline.

5.1.2 Live configuration

Configure IP camera live parameters.

Channel	Setup	Privacy Mode	Channel Name	Show Name	Date Format	Time Format	Show Time	Refresh Rate
CH1		<input type="checkbox"/>	529+4210poe	<input checked="" type="checkbox"/>	YYYY/MM/DD	24 Hour	<input checked="" type="checkbox"/>	60Hz
CH2		<input type="checkbox"/>	30kq824	<input checked="" type="checkbox"/>	YYYY/MM/DD	24 Hour	<input checked="" type="checkbox"/>	60Hz
CH3		<input type="checkbox"/>	Camera	<input type="checkbox"/>	DD/MM/YYYY	24 Hour	<input type="checkbox"/>	60Hz
CH4		<input type="checkbox"/>	Camera823	<input checked="" type="checkbox"/>	YYYY/MM/DD	24 Hour	<input checked="" type="checkbox"/>	60Hz
CH5		<input type="checkbox"/>	1111122222333334444455555666667	<input checked="" type="checkbox"/>	MM/DD/YYYY	24 Hour	<input checked="" type="checkbox"/>	60Hz
CH6		<input type="checkbox"/>	338g	<input checked="" type="checkbox"/>	YYYY/MM/DD	12 Hour	<input checked="" type="checkbox"/>	50Hz
CH7		<input type="checkbox"/>		<input checked="" type="checkbox"/>	YYYY/MM/DD	24 Hour	<input checked="" type="checkbox"/>	60Hz
CH8		<input type="checkbox"/>	529+4210one	<input checked="" type="checkbox"/>	YYYY/MM/DD	24 Hour	<input checked="" type="checkbox"/>	50Hz
CH9		<input type="checkbox"/>	lll	<input checked="" type="checkbox"/>	YYYY/MM/DD	24 Hour	<input checked="" type="checkbox"/>	50Hz
CH10		<input type="checkbox"/>	live	<input checked="" type="checkbox"/>	YYYY/MM/DD	24 Hour	<input checked="" type="checkbox"/>	60Hz
CH11		<input type="checkbox"/>	529-850	<input checked="" type="checkbox"/>	MM/DD/YYYY	24 Hour	<input checked="" type="checkbox"/>	50Hz
CH12		<input type="checkbox"/>	16>z<338g	<input checked="" type="checkbox"/>	YYYY/MM/DD	24 Hour	<input checked="" type="checkbox"/>	60Hz
CH13		<input type="checkbox"/>	Camera	<input checked="" type="checkbox"/>	YYYY/MM/DD	24 Hour	<input checked="" type="checkbox"/>	50Hz
CH14		<input type="checkbox"/>		<input checked="" type="checkbox"/>	YYYY/MM/DD	24 Hour	<input checked="" type="checkbox"/>	50Hz
CH15		<input type="checkbox"/>		<input checked="" type="checkbox"/>	MM/DD/YYYY	24 Hour	<input checked="" type="checkbox"/>	60Hz
CH16		<input type="checkbox"/>	1200	<input checked="" type="checkbox"/>	MM/DD/YYYY	24 Hour	<input checked="" type="checkbox"/>	50Hz
CH17		<input type="checkbox"/>	529+11	<input checked="" type="checkbox"/>	YYYY/MM/DD	24 Hour	<input checked="" type="checkbox"/>	60Hz
CH18		<input type="checkbox"/>	338g	<input checked="" type="checkbox"/>	YYYY/MM/DD	24 Hour	<input checked="" type="checkbox"/>	50Hz

Channel: Display of the channel name

Privacy Mode: Privacy mode. During privacy mode enabled, there are no images for preview and playback, and the setting page does not display preview images.

Setup: Click icon to enter the Settings page.

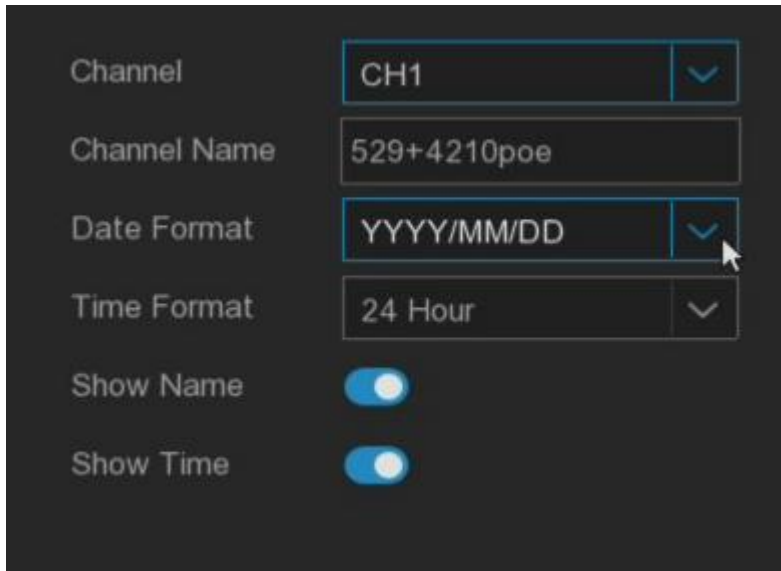

Channel Name: Set the channel name.

Date Format: Set the date format for the IP camera OSD display.

Time Format: Set the time format for the IP camera OSD display.

Refresh Rate: Set the refresh rate of the IP camera.

Show Name: Preview displays the IP camera channel name.

Show Time: Preview displays the IP camera time.

This page supports the display of date format OSD, time format OSD, and Cross-counting statistics OSD (Cross counting function is enabled) in the image.

5.1.3 Image control

This menu is used to set the image parameters for IP camera.

Channel	Setup	Image Mode	IR-CUT Mode	Vertical Flip	Horizontal Flip	Angle Adjustment	BLC Level	3D Noise Reduction	DWDR	AGC
CH1 (529+4210poe)		Day/Night Mode	Image	OFF	OFF	180	OFF	Auto	OFF	
CH2 (30k824)			GPIO Auto	OFF	OFF	0	OFF	Auto	OFF	
CH3 (Camera)		Day/Night Mode	Automatic mode	OFF	OFF	0	OFF	Auto	OFF	
CH4 (Camera823)		Day/Night Mode	Image	OFF	OFF	180	OFF	Auto	OFF	
CH5 (1111122222333334444455555666667)		Day/Night Mode	Automatic mode	OFF	OFF	0	OFF	Auto	OFF	
CH6 (338g)			Color Mode	OFF	OFF	0	OFF	Auto	OFF	
CH7 (30k)		Day/Night Mode	Image	OFF	OFF	0	OFF	Auto	OFF	
CH8 (529+4210one)		Day/Night Mode	Day	OFF	OFF	180	OFF	Auto	OFF	
CH9 (ll)		Full Color Mode		OFF	OFF	180	OFF	Auto	OFF	
CH10 (lve)		Day/Night Mode	Image	OFF	OFF	0	OFF	Auto	OFF	

Channel: Channel name.

Setup: Click to enter settings page.



Channel: Select the channel that you want to configure.

Image Mode: Set the camera image mode, total three modes.

Full Color Mode: When surrounding illumination is insufficient, the warming light is on.

Day / Night Mode: When surrounding illumination is insufficient, the IR light is on for supplementary lighting. When surrounding illumination is sufficient, the IR light turns off and the IR light finish supplementary.

Smart Illumination: Intelligent light mode, when surrounding illumination is insufficient, alarm will trigger the warming light on, the alarm end of the warming light off.

White Light: In **FullColor** mode, set the lighting effect of the camera warming light effect, total four modes.

Automatic mode: Automatic mode, the camera automatically adjusts the intensity of the warm light according to the ambient illumination.

Manual: Fixed brightness value, the surrounding light.

Schedule: By setting schedule table to automatically switch the supplment light.

OFF: Disbale the warming light.

Sensitivity: Level from 0 to 3, the camera perception of surrounding light, the higher the value, the more sensitive.

Light Distance: The range is 0-100, white light is to adjust the brightness of the supplementary light in Manual mode, the higher the value, the higher the brightness.

IR-Cut Mode: In Day / Night Mode mode, set the camera IR-Cut switching mode in 5 modes.

Auto / GPIO Auto: Automatic control switch mode, color switch black and white by image judgment, black and white conversion color by photosensitive judgment.

Day / Color Mode: Force the color mode, do not switch between black and white.

Night / Black White Mode: Force black and white mode, do not switch color.

Image File (s) / Image Control: Similar to the automatic mode, control the color to black and black to color mode through the image Schedule or B/W.

Schedule: Switch between black and white and color through schedule settings. Enable this feature, you need to set the start and end time to enter the night vision.

IR-LED Control: Set the warming light effect of the camera IR light during night vision, there are three modes.

SmartIR: Intelligent control of supplement light intensity, according to the focal length, whether the picture is overexposive dynamic control of IR light.

Manual: Manual mode to fill the brightness of the set IR light.

OFF: Disable IR light.

Low Beam Light: The brightness of the first group of IR lights can be manually adjusted. (0~100, the IR light is not bright when set to 0, and the brightest at 100).

High Beam Light: The brightness of the IR light of the second group (if the camera supports) can be manually adjusted (0~100, the IR light is not bright when set to 0, and the light is brightest at 100).

Hue: Adjust the image tone.

Brightness: Adjust the image brightness.

Contrast: Adjust the image contrast ratio.

Saturation: Adjust the image saturation degree.

Sharpness: Adjust the image sharpness.

Anti-Overexposure: Image anti-overexposure function.

Vertical Flip: Flips the image upside down.

Horizontal Flip: Mirrors the image horizontally.

Corridor Mode: Optimizes the camera's vertical viewing angle for monitoring long, narrow scenes like hallways or corridors. Enable this mode if your camera is aimed along a corridor.

Angle Adjustment: Allows to set the flip angle.

Exposure Compensation: Set the exposure compensation, there are four modes.

WDR: Wide dynamic range in which the picture is uniformly balanced based on the setting and both light and dark areas can be clearly distinguished. (DWDR here for some models).

HLC: Highlight compensation in which the objects in the highlighted area are clearer in the picture. (applicable for some models).

Back Light: Backlight compensation in which the objects in the dark area are clearer.

Disable: Image will not be optimized with backlight on.

3D Noise Reduction: Reduce the noise in the image to make the picture more clear. There are three modes.

Automatic mode: Camera automatically applies noise reduction algorithms.

OFF: Disable noise reduction.

Manual: Make noise reduction according to the manually set noise reduction coefficient.

White Balance: White balance setting, there are two modes

Automatic mode: Adjust the white light with the default parameters of the program.

Manual: Manually set red, green and blue gain synthesis white light.

Shutter: Set the length of the shutter exposure, there are two modes.

Automatic mode: Based on the value of the currently set Time Exposure, the program automatically selects an appropriate exposure time.

Manual: Use the configured Time Exposure value.

Exposure Time: Set the exposure time to use in conjunction with the Shutter setting. If the Shutter mode is set to Manual, this value determines the fixed shutter speed. If the Shutter mode is set to Auto, this value sets the slowest shutter speed limit. The camera will automatically select the most suitable shutter speed between this slowest limit and the fastest speed displayed by the system for proper exposure. For example, if set to 1/30, the shutter speed will automatically adjust within the range of 1/30 to 1/20000 for optimal exposure.

AGC: Adjusts Automatic Gain Control levels to boost sensor gain in low-light, ensuring proper exposure and preventing underexposure. (Manual adjustment supported on some models.)

Defog Mode: Optimizes visibility on foggy days(Need camera support). There are three modes.

OFF: Disable defog function.

Automatic mode: The camera automatically judges the effect of defogging.

Manual: Defist according to the manually set values.

Lens Distortion Correction: Lens distortion correction (ultra-wide Angle camera support).

FoV Adjustment: The correction level can be adjusted after enabling the lens distortion correction,Level 0-5 are optional.

Default: Click this button to restore the factory default settings for all image parameters.

5.1.4 Record and Encode Settings

This menu configures the image parameters for recording video or network transmission.

Generally, main stream is the quality of the recorded video saved in the HDD. Substream is the preview video quality through remote access (such as Web clients and CMS). The mobile stream defines the preview quality of viewing through remote access using mobile device, setting the switch of the connected webcam's audio, the volume of the input and output, and the audio type.

5.1.4.1 Recording settings

This menu can configure the relevant parameters of the system record.

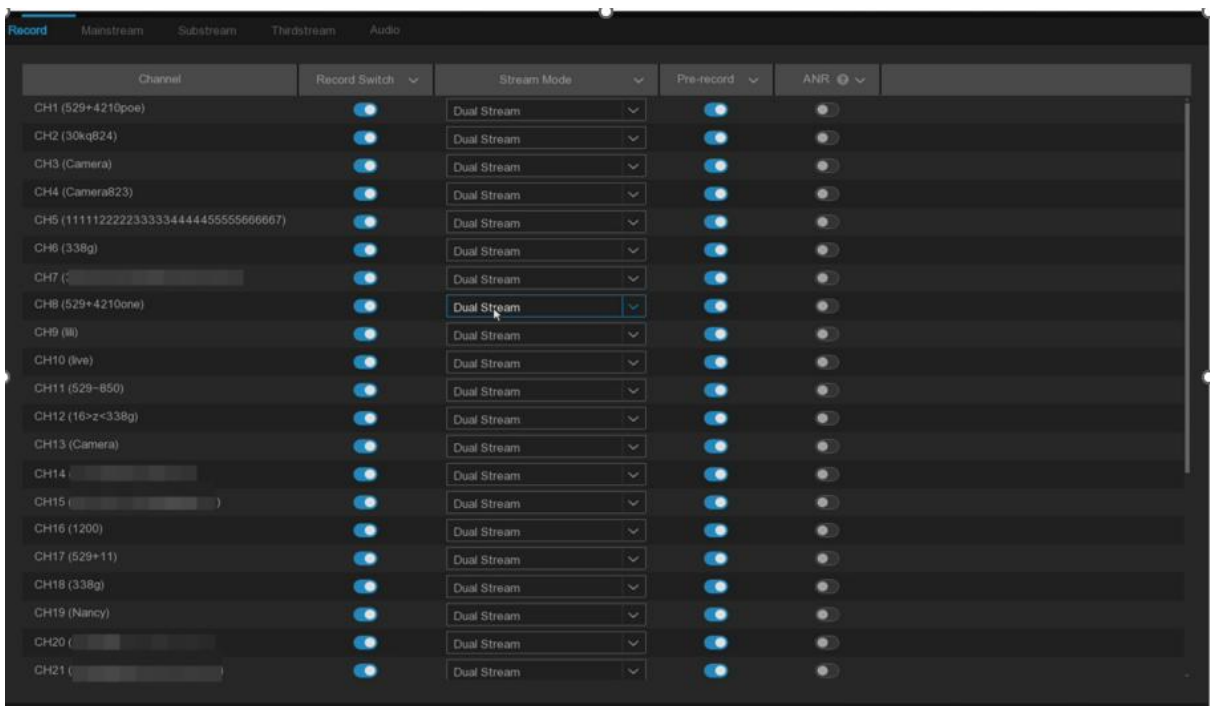

Switch: Select to enable recording in this channel.

Stream Mode : Select the recording type. If you select the dual stream, the system will record both main stream and sub stream. If selected main stream, the system will only record main stream video.

PreRecord: This allows your NVR to capture video for several seconds before an event occurs. It is recommended to keep this enabled.

ANR(Automatic Network Replenishment): Normally, videos are stored on the NVR when the network connection between the NVR and cameras is working. With the ANR (Automatic Network Replenishment) function enabled, the camera will start continuously recording to its SD card if the connection is lost. Once the network is restored, the recordings on the camera's SD card will be transferred back to the NVR's storage. It is recommended to enable ANR if your camera supports this feature(Only main stream will records).

5.1.4.2 Main stream

Channel	Resolution	Frame Rate	Encoding Format	Encoding Mode	Video Quality	Config Mode	Bitrate
CH1 (529+4210poe)	2560 x 1440	30	H.265	CBR		Predefined	3072
CH2 (30kg924)	1280 x 960	30	H.264	CBR		Predefined	2048
CH3 (Camera)	1920 x 1080	30	H.265+	CBR		Predefined	2048
CH4 (Camera823)	2560 x 1440	30	H.264	CBR		Predefined	8192
CH5 (111112222333334444455555666667)	2560 x 1440	30	H.264	CBR		Predefined	8192
CH6 (338g)	1280 x 960	25	H.265	CBR		Predefined	2048
CH7 ()	2880 x 1620	30	H.265	CBR		Predefined	3072
CH8 ()	2560 x 1440	15	H.265	CBR		Predefined	2048
CH9 (ll)	2688 x 1520	25	H.264	CBR		Predefined	4096
CH10 (lve)	1280 x 960	30	H.264+	CBR		Predefined	2048
CH11 (529-850)	3840 x 2160	25	H.265	CBR		Predefined	8192
	3840 x 2160	25	H.265	CBR		User-defined	8192
CH12 (16>2<338g)	1280 x 960	30	H.265	CBR		Predefined	2048
CH13 (Camera)	1280 x 960	25	H.265	VBR	Highest	User-defined	2048
CH14 ()	2880 x 1620	15	H.265	CBR		Predefined	4096
CH15 ()	1920 x 1080	26	H.265	CBR		Predefined	2048
CH16 (1200)	4512 x 2512	15	H.265	CBR		Predefined	3072
	4512 x 2512	15	H.265	VBR	Highest	Predefined	8192
CH17 (529+11)	3840 x 2160	25	H.264	CBR		Predefined	8192
CH18 (338g)	1280 x 960	15	H.265	CBR		Predefined	1024
CH19 (Nancy)	3840 x 2160	25	H.265	CBR		Predefined	8192

Resolution: Determine the record to main stream type. Higher values offer greater detail. The default resolution is auto-selected by your NVR.

Frame Rate: Set the frame number of the main stream.

Encoding Format: List the supported codec for the connected camera. H.265 compresses information more efficiently for better video quality at a given bandwidth. H.265+ offers even greater compression. H.264 requires higher bandwidth and offers less efficient compression.

H.264+ provides additional compression compared to H.264. Please note that only some devices support H.264+ and H.265+. Please note that in the substream, some cameras also support the MJPEG format. If you choose this encoding format, during preview, only one channel of MJPEG encoding will be displayed.

Encoding Mode: For simple scenarios, such as gray wall, a constant bit rate (CBR). For more complex scenarios, such as busy streets, a variable bit rate (VBR) is appropriate.

Video Quality: Available only for VBR, this setting allows to select the recording quality, here are several options like **Lowest**, **Lower**, **Low**, **Medium**, **Higher**, **Highest**.

Config Mode: Select either User-defined mode to manually set the bitrate or Predefined mode to choose from predefined bitrate.

Bitrate: Determines the speed of data transfer used for video recording. Higher bitrates result in better-quality recordings but require more bandwidth. Adjust incrementally until satisfied with image quality.

Audio: Enables or disables audio recording if your camera supports it. Make sure to enable Audio streaming in the Audio Encoding section if you want to record audio.

I Frame Interval: This parameter sets the interval between I frames (keyframes) in the IP camera's stream. I frames are full frames, while other frames are encoded based on the differences from preceding frames (P frames or B frames). A shorter interval can improve video quality but may increase bandwidth usage.

ETR: ETR (Event Trigger Recording) allows to adjust codec stream parameters for recording based on whether an alarm is present or not. This optimization ensures that crucial events, such as motion detection or alarm activation, are captured with optimal quality and efficiency.

5.1.4.3 Sub stream

Channel	Resolution	Frame Rate	Encoding Format	Encoding Mode	Video Quality	Config Mode	Bit
CH1 (529+4210poe)	320 x 240	30	H.265	CBR		Predefined	512
CH2 (30kq824)	1280 x 720	30	H.265	CBR		Predefined	1024
CH3 (Camera)	640 x 480	30	H.265	CBR		Predefined	1024
CH4 (Camera823)	640 x 480	30	H.265	CBR		Predefined	512
CH5 (1111122222333334444455555666667)	1280 x 720	30	H.265	CBR		Predefined	1024
CH6 (338g)	1280 x 720	20	H.264	CBR		Predefined	768
CH7 ()	640 x 480	30	H.265	CBR		Predefined	320
CH8 (529+4210one)	640 x 480	25	H.265+	CBR		Predefined	320
CH9 (ll)	1920 x 1080	25	H.265	CBR		Predefined	2048
CH10 (lve)	1280 x 720	25	H.264	CBR		User-defined	1024
CH11 (529-850)	1280 x 720	23	H.264	CBR		Predefined	1024
CH12 (16>z<338g)	1280 x 720	30	H.265	CBR		Predefined	1024
CH13 (Camera)	640 x 480	25	H.265	CBR		Predefined	320
CH14 (3)	1280 x 720	25	H.264	CBR		Predefined	1024
CH15 (5)	1280 x 720	30	H.264	CBR		Predefined	1024
CH16 (1200)	1920 x 1080	15	H.265+	CBR		Predefined	1024
CH17 (529+11)	640 x 480	25	H.264	VBR	Highest	Predefined	320
CH18 (338g)	640 x 480	25	H.264	CBR		Predefined	320
CH19 (Nancy)	1280 x 720	25	H.265	CBR		Predefined	1024

Resolution: Determine the record to sub stream type. Higher values offer greater detail. The default resolution is auto-selected by your NVR.

Frame Rate: Specifies the number of frames recorded per second. The default frame rate is auto-selected by your NVR.

Encoding Format: Lists the supported codec for the connected camera. H.265 compresses information more efficiently for better video quality at a given bandwidth. H.265+ offers even greater compression. H.264 requires higher bandwidth and offers less efficient compression. H.264+ provides additional compression compared to H.264. Please note that only some devices support H.264+ and H.265+. Please note that in the substream, some cameras also support the MJPEG format. If you choose this encoding format, during preview, only one channel of MJPEG encoding will be displayed.

Encoding Mode: For simple scenarios, such as gray wall, set constant bit rate (CBR). For more complex scenarios, such as busy streets, variable bit rate (VBR) is appropriate.

Video Quality: Available only for VBR, this setting allows to select the recording quality, here are several options like **Lowest**, **Lower**, **Low**, **Medium**, **Higher**, **Highest**.

Config Mode: Select either User-defined mode to manually set the bitrate or Predefined mode to choose from predefined bitrate.

Bitrate: Determines the speed of data transfer used for video recording. Higher bitrates result in better-quality recordings but require more bandwidth. Adjust incrementally until satisfied with image quality.

Audio: Enables or disables audio recording if your camera supports it. Make sure to enable Audio streaming in the Audio Encoding section if you want to record audio.

I Frame Interval: This parameter sets the interval between I frames (keyframes) in the IP camera's stream. I frames are full frames, while other frames are encoded based on the differences from preceding frames (P frames or B frames). A shorter interval can improve video quality but may increase bandwidth usage.

5.1.4.4 The third stream

Channel	Switch	Resolution	Frame Rate	Encoding Format	Encoding Mode	Config Mode	Bitrate
CH1 (529+4210poe)	<input checked="" type="checkbox"/>	640 x 480	30	H.265	CBR	Predefined	512
CH2 (30kq824)	<input checked="" type="checkbox"/>	640 x 480	30	H.265	CBR	Predefined	512
CH4 (Camera823)	<input checked="" type="checkbox"/>	640 x 480	30	H.265	CBR	Predefined	512
CH5 (11111222233333444445555666667)	<input checked="" type="checkbox"/>	640 x 480	30	H.265	CBR	Predefined	512
CH6 (338g)	<input type="checkbox"/>	640 x 480	25	H.265	CBR	Predefined	512
CH7 ()	<input checked="" type="checkbox"/>	640 x 480	30	H.265	CBR	Predefined	512
CH8 (529+4210one)	<input checked="" type="checkbox"/>	640 x 480	25	H.265	CBR	Predefined	512
CH9 (ll)	<input checked="" type="checkbox"/>	640 x 480	25	H.265	CBR	Predefined	1024
CH10 (live)	<input checked="" type="checkbox"/>	640 x 480	25	H.265	CBR	Predefined	512
CH11 (529-850)	<input checked="" type="checkbox"/>	640 x 480	25	H.265	CBR	Predefined	512
CH12 (16>z<338g)	<input checked="" type="checkbox"/>	640 x 480	30	H.265	CBR	Predefined	512
CH13 (Camera)	<input checked="" type="checkbox"/>	640 x 480	25	H.265	CBR	Predefined	512
CH14 ()	<input checked="" type="checkbox"/>	640 x 480	25	H.265	CBR	Predefined	512
CH15 ()	<input checked="" type="checkbox"/>	640 x 480	30	H.265	CBR	Predefined	512
CH16 (1200)	<input checked="" type="checkbox"/>	640 x 480	15	H.265	CBR	Predefined	512
CH17 (529+11)	<input checked="" type="checkbox"/>	640 x 480	25	H.265	CBR	Predefined	512
CH18 (338g)	<input checked="" type="checkbox"/>	640 x 480	25	H.265	CBR	Predefined	512
CH19 (Nancy)	<input checked="" type="checkbox"/>	640 x 480	25	H.265	CBR	Predefined	512
CH20 ()	<input checked="" type="checkbox"/>	640 x 480	20	H.265	CBR	Predefined	512
CH21 ()	<input checked="" type="checkbox"/>	640 x 480	25	H.265	CBR	Predefined	512
CH22 ()	<input checked="" type="checkbox"/>	640 x 480	30	H.265	CBR	Predefined	512

Switch: Enable or disable the third stream.

Resolution: Determine the record to the third stream type. Higher values offer greater detail. The default resolution is auto-selected by your NVR.

Frame Rate: Specifies the number of frames recorded per second. The default frame rate is auto-selected by your NVR.

Encoding Format: Lists the supported codec for the connected camera. H.265 compresses information more efficiently for better video quality at a given bandwidth. H.265+ offers even greater compression. H.264 requires higher bandwidth and offers less efficient compression.

H.264+ provides additional compression compared to H.264. Please note that only some devices

support H.264+ and H.265+. Please note that in the substream, some cameras also support the MJPEG format. If you choose this encoding format, during preview, only one channel of MJPEG encoding will be displayed.

Encoding Mode: For simple scenarios, such as gray wall, set constant bit rate (CBR). For more complex scenarios, such as busy streets, variable bit rate (VBR) is appropriate.

Video Quality: Available only for VBR, this setting allows to select the recording quality, here are several options like **Lowest**, **Lower**, **Low**, **Medium**, **Higher**, **Highest**.

Config Mode: Select either User-defined mode to manually set the bitrate or Predefined mode to choose from predefined bitrate.

Bitrate: Determines the speed of data transfer used for video recording. Higher bitrates result in better-quality recordings but require more bandwidth. Adjust incrementally until satisfied with image quality.

Audio: Enables or disables audio recording if your camera supports it. Make sure to enable Audio streaming in the Audio Encoding section if you want to record audio.

I Frame Interval: This parameter sets the interval between I frames (keyframes) in the IP camera's stream. I frames are full frames, while other frames are encoded based on the differences from preceding frames (P frames or B frames). A shorter interval can improve video quality but may increase bandwidth usage.

5.1.4.5 Audio Encoding

If your camera includes a built-in microphone or an external audio input device, you can activate the audio stream. You can then adjust the input/output volume and select the audio encode

type.

Channel	Enable	Audio Input Type	Type	Input Volume	Output Volume
CH1 (529+4210poe)		Mic By Camera	G711A	9	9
CH2 (30kq824)			G711U	3	0
CH3 (Camera)			G711A	7	7
CH4 (Camera823)	<input checked="" type="checkbox"/>		G711A	10	0
CH5 (1111122222333334444455555666667)	<input checked="" type="checkbox"/>		G711U	8	9
CH6 (338g)			G711A	6	
CH7 (30)		Mic By Camera	G711A	9	9
CH8 (529+4210one)		Mic By Camera	G711A	2	9
CH9 (III)	<input checked="" type="checkbox"/>		G711U	9	9
CH10 (live)			G711A	8	8
CH11 (529-850)		Mic By Camera	G711A	9	9
CH12 (16>z<338g)			G711A	7	
CH13 (Camera)			G711A	7	7
CH14 (30)		Mic By Camera	G711A	9	9

Enable: Tick to enable or disable audio.

Audio Input Type: This is to define the volume level of the audio output on the NVR locally.

Mic By Camera: Select the camera microphone input.

Line In: Select the camera audio line in.

Type: Choose the audio encoding codec, there are 711U and 711A.

Input Volume: Adjust the audio input volume.

Output Volume: Adjust the audio output volume.

5.1.5 Image Capture

You can enable and schedule your NVR to capture snapshots during normal recording periods or whenever an event is triggered. This functionality aids in rapidly identifying alarm incidents and the snapshots can additionally be used for creating time-lapse video.

Channel	Auto Capture	Normal Interval	Alarm Interval	Picture Resolution
CH1 (529+4210poe)	<input checked="" type="checkbox"/>	5 s	5 s	1920 x 1080
CH2 (30kq824)	<input checked="" type="checkbox"/>	5 s	5 s	1920 x 1080
CH3 (Camera)	<input checked="" type="checkbox"/>	5 s	5 s	1920 x 1080
CH4 (Camera823)	<input checked="" type="checkbox"/>	5 s	5 s	640 x 480
CH5 (11111222233334444555566667)	<input checked="" type="checkbox"/>	5 s	5 s	640 x 480
CH6 (338g)	<input checked="" type="checkbox"/>	5 s	5 s	1920 x 1080
CH7 ()	<input checked="" type="checkbox"/>	5 s	5 s	1920 x 1080
CH8 (529+4210one)	<input checked="" type="checkbox"/>	5 s	5 s	1920 x 1080
CH9 (III)	<input checked="" type="checkbox"/>	5 s	5 s	640 x 480
CH10 (live)	<input checked="" type="checkbox"/>	5 s	5 s	1920 x 1080
CH11 (529-850)	<input checked="" type="checkbox"/>	5 s	5 s	1920 x 1080
CH12 (16>z<338g)	<input checked="" type="checkbox"/>	5 s	5 s	1920 x 1080
CH13 (Camera)	<input checked="" type="checkbox"/>	5 s	5 s	1920 x 1080
CH14 ()	<input checked="" type="checkbox"/>	5 s	5 s	1920 x 1080
CH15 ()	<input checked="" type="checkbox"/>	5 s	5 s	1920 x 1080

Auto Capture: Enable or disable snapshot capturing for this channel.

Normal Interval: The time interval between taking snapshots during regular recording periods.

Alarm Interval: The interval for capturing snapshots when events like motion detection, I/O alarm.

Capture Resolution: When the channel grasps, it can grasp according to the set resolution.

5.1.6 PTZ

This menu allows to configure the PTZ (Pan/Tilt/Zoom) settings for High-Speed dome .

Channel	Signal Type	Protocol	Baudrate	DataBit	StopBit	Parity
CH1 (529+4210poe)	Digital	Pelco-D	9600	8	1	None
CH2 (30kq824)	Digital	Pelco-D	9600	8	1	None
CH3 (Camera)	Digital	Pelco-D	9600	8	1	None
CH4 (Camera823)	Digital	Pelco-D	1200	8	1	None
CH5 (11111222233334444555566667)	Digital	Pelco-D	9600	8	1	None
CH7 ()	Digital	Pelco-D	9600	8	1	None
CH8 (529+4210one)	Digital	Pelco-D	9600	8	1	None
CH11 (529-850)	Digital	Pelco-D	9600	8	1	None
CH13 (Camera)	Digital	Pelco-D	9600	8	1	None
CH14 ()	Digital	Pelco-D	9600	8	1	None
CH15 ()	Digital	Pelco-D	9600	8	1	None

Channel: Channel name.

Signal Type: If your PTZ camera is connected to the RS485 port, then choose "Analog", otherwise choose "Digital".

Protocol: Choose the communication protocol between the PTZ-enabled camera and the NVR. If the camera supports UTC (up coaxial) function, you can select COAX 1 or COAX 2 to display the camera's OSD menu or control UTC PTZ function.

Baudrate: The speed at which data is transmitted from the NVR to the PTZ camera. Ensure it matches the supported baud rate of your PTZ camera.

DataBit / StopBit: Data between the NVR and PTZ camera is sent in individual packets. The Data Bit indicates the number of bits in each data packet, while the Stop Bit signals the end of one packet and start of the next. Available Data Bit options are: 8, 7, 6, 5. Available Stop Bit options are 1 or 2.

Parity: For error checking. Refer to your PTZ camera's documentation to configure this setting properly.

Address: Set the command address for the PTZ system. Note that each PTZ camera requires a unique address to function correctly.

Focus mode: There are three focus modes available.

- **Auto:** Automatically focuses based on scene changes.
- **Semi-auto:** Default mode. Focuses once after panning or zooming, and does not refocus with scene changes.
- **Manual:** The user manually focuses using the focus buttons on the preview interface. Panning, zooming, and scene changes do not trigger refocusing.

Zoom Status: The zoom status of the camera. The zoom level is displayed in the lower left corner of the preview interface. You can choose whether to display it or how long to display it.

Pan & Tilt Status: In the lower left corner of the preview screen, the horizontal and vertical azimuth of the camera will be displayed. You can choose whether or not to display it or how long to display it.

Preset Status: The preset status of the camera. The preset point number is displayed in the lower left corner of the preview interface when a preset is called. You can choose whether to display it or how long to display it.

Min. Focus Distance: When the distance between the scene object and the lens is less than the minimum focus distance, the lens will not change the focus on that object and will prioritize focusing on objects at distances greater than the "Minimum Focus Distance" parameter. For example, if the minimum focus distance is set to 6 meters, you can set a baffle at 1.5 meters to block part of the lens's field of view, with one half showing a distant view and the other a close view. The camera will prioritize focusing on the distant view beyond 6 meters.

5.1.6.1 High-Speed Dome Control

After completing the PTZ setting, the PTZ function can be used to control the High-Speed Dome camera.

Click the left mouse button in the live preview channel, tool bar at the bottom of the channel, click  icon to enter PTZ control panel.

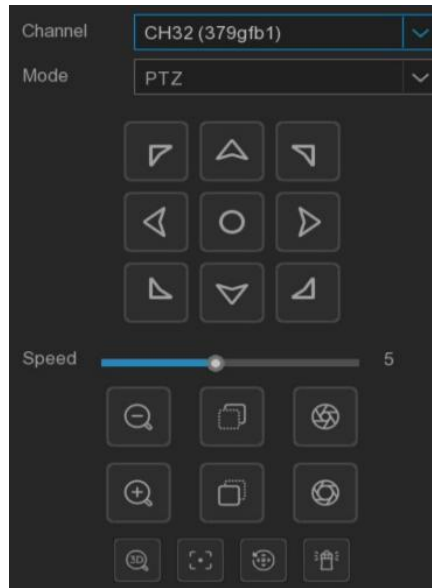

Channel: Select channel.



Mode: PTZ move control mode, there are six modes including **PTZ**, **Preset**, **Line Scan**, **Watch Mode**, **Tour**, **Pattern Scan**.

SPEED: The PTZ speed adjustment horizontal bar is divided into 1-10 gears, the larger the value, the faster the rotation speed.

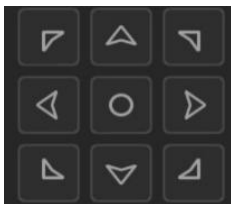

Direction Control Buttons:





Clicking any of the 8 directional arrows will cause the camera's pan/tilt to make a slight movement in the corresponding direction.

Holding down one of the arrows will result in continuous rotation in that direction for the camera's pan/tilt. Clicking the center button  initiates continuous horizontal rotation, and the button will change to  during this action. Clicking it again will stop the rotation.





Represents "focus-" and "focus +". When pressing  button, the lens pulls close and the scene enlarges. When pressing  button, the lens pulls away and the scene becomes smaller.



Represents "focus-" and "focus- +". In manual focus mode, hold on  icon, the nearby objects become clear and the distant objects gradually blur. Hold on  icon, the distant objects become clear and the nearby objects gradually become blurred.



Represents "aperture-" and "aperture +". When the monitoring screen is relatively dark, you can hold  to increase the aperture. Instead, you can hold  to reduce the aperture value.

Click  to enable 3D positioning, and the button icon will turn blue; click the button again to stop 3D positioning. When the camera's 3D positioning is enabled, you can perform the following operations:

Use the left mouse button to click on a specific point in the preview window, and the camera will move the clicked point to the center of the screen.

Hold down the left mouse button and drag to the right to create a rectangular area, then release the button. The camera will move the outlined area to the center of the screen and zoom in for a closer view.

Hold down the left mouse button and drag to the left to create a rectangular area, then release the button. The camera will move the outlined area to the center of the screen and zoom out for a wider view.

click  button, and the camera will automatically focus.

One-Click Reset, click  button, the camera will clear all preset points and cruise paths.

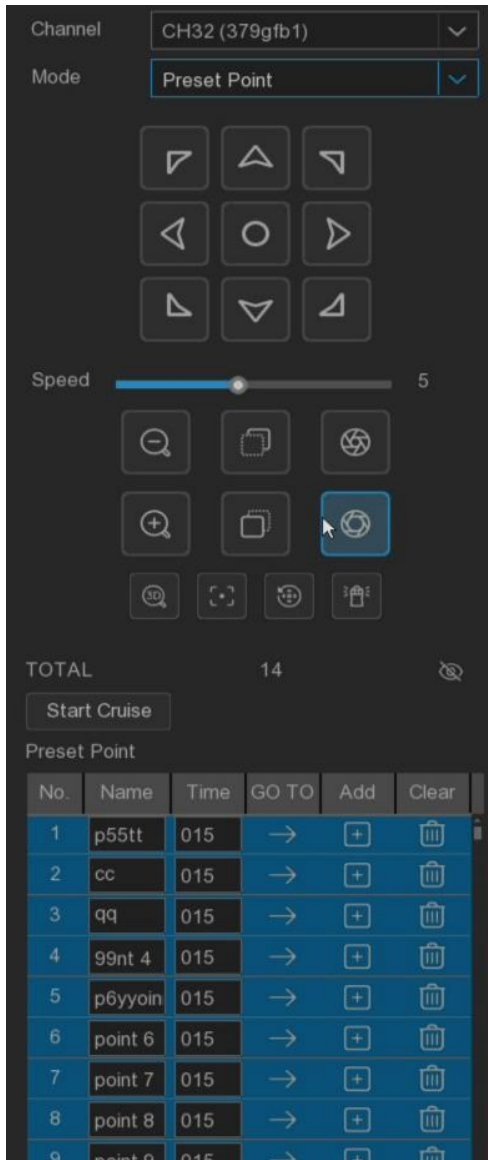

One-Click watch, click  to perform a one-click watch, this function depends on the model, please refer to the actual interface.

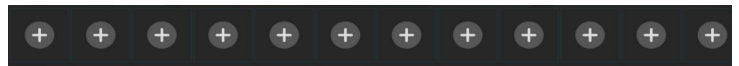

PRESET mode:

Click  icon, the preset points display below the preview screen, as shown in below picture.



Operating the cradle head controlled orientation key to turn the cradle head to the location to be saved, click  or  to add the preset points in the figure above, and display the preset point screen below the preview interface. On the left, the set preset points will be dark display, and the unset preset points will be displayed in gray.

Click  icon will rotate to the position set by the preset point, and take the shortest path.

frame, modify the preset point name. Click **Time** frame, modify the cruise time at this preset point.

Click  to delete the preset points.

Click on the Start Cruise to start cruising.

Note: Up to 255 preset points are supported.

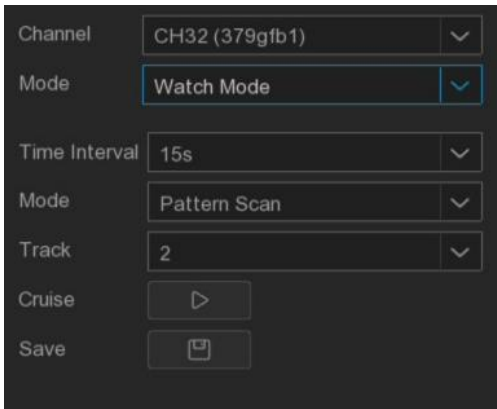

Watch Mode: When the PTZ enabled watch mode function, after the set watch waiting time, no control signal comes, the PTZ dome will automatically perform the preset action.

Time Interval: Watch waiting time, the interval between the stop operation and the continue watch action.

Mode: Select watch mode, you can select **Default Cruise**, **Preset Points Cruise**, **Line Scan**, **Track Cruise**, **Pattern Scan**.

Click  start the cruise.

Note: Only one watch point can be present.

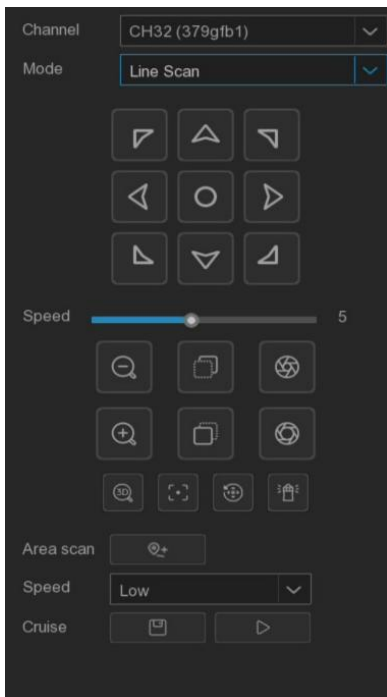

Line Scan: Line Scan allows the camera to automatically pan horizontally between position A and position B.

Area scan: Click  to record the start location, move PTZ and click  to record the stop location.

Speed: Select the Line Scan cruise speed, here are **Low**, **Medium**, **High**.

Click  to Line Scan cruise, The device will cruise at a constant speed between the start position and the end position.

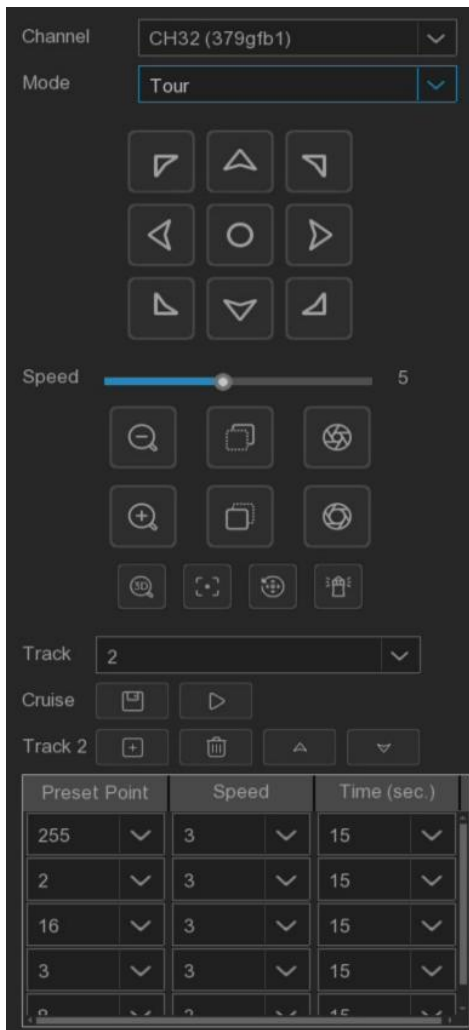

Tour Cruise: You are able to configure a maximum of 4 tracks of automatic cruise sequences by selecting different preset points. To make full use of this Tour function, please ensure that several preset points have already been configured.

Track: Select track path.

Click add preset points, click delete preset points. click / move up / down.

Click start a cruise, and the device will cruise in the order of the preset bits added.

Note: After adding the preset point, you should click the cruise button to save the track path

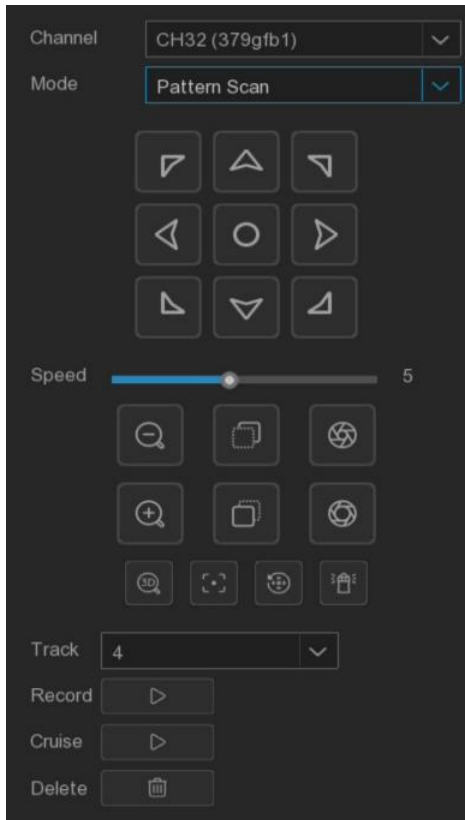

Pattern Scan: Pattern scanning refers to the scanning according to the pre-set path, recording the horizontal and vertical movement, multiplier operation and other actions of the PTZ. After recording and saving, the pattern scanning route can be directly called. This function supports setting 4 pattern scan paths and provides saving options for each pattern scan path.

Track: Select track path.

Record: Click  start recording cruise track, conduct an arbitrary PTZ operation on the device.

Click  to stop recording cruise track.

Click  to cruise along previously recorded routes and movements.

5.1.6.2 PTZ schedule (This function only supports on High-Speed Dome)

Click [Task Schedule](#) to set High-Speed Dome task schedule. The setting interface is shown in the following figure. User can set High-Speed Dome to automatically perform different cruise tasks in different time periods.

privacy area required to enable. The area is displayed as the yellow box. Click the edge section of the yellow box and drag it to any size to create the privacy area.

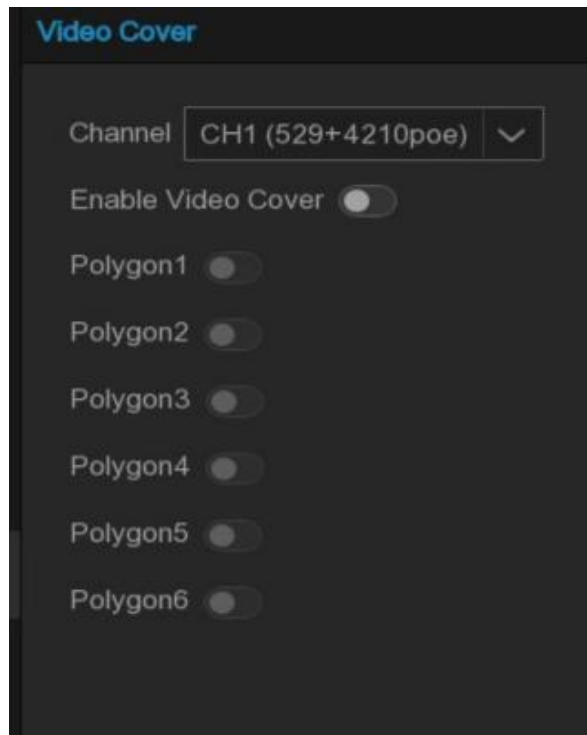

Enable Video Cover: Enable or disable Video Cover function. When enabled, the set privacy area can be covered, and the covered area will not be seen in the preview and playback.

Polygon: Multiple privacy areas can be set in the screen, each area can be moved, stretch.

Click **Apply** to save and take effect.

Note: The video cover is set up, and the picture covered by the privacy area is not visible during preview and playback.

5.2 Storage

5.2.1 Schedule

5.2.1.1 Record schedule

This menu set when NVR records the video and determine the recording mode for each channel.

The recording schedule sets up record schdeule, such as **Normal** (continuous) daily (hourly)

recording, **Motion** recording and **I/O** recording. To set the video mode, click (General, Motion, I/O)

button and drag the cursor to mark the area or manually add the recording period in List form.

The recording schedule is valid for only one channel. If you want to use the same recording

schedule for another channels, click **Copy** to use the replication feature. Click **Save Template** to

save the settings.

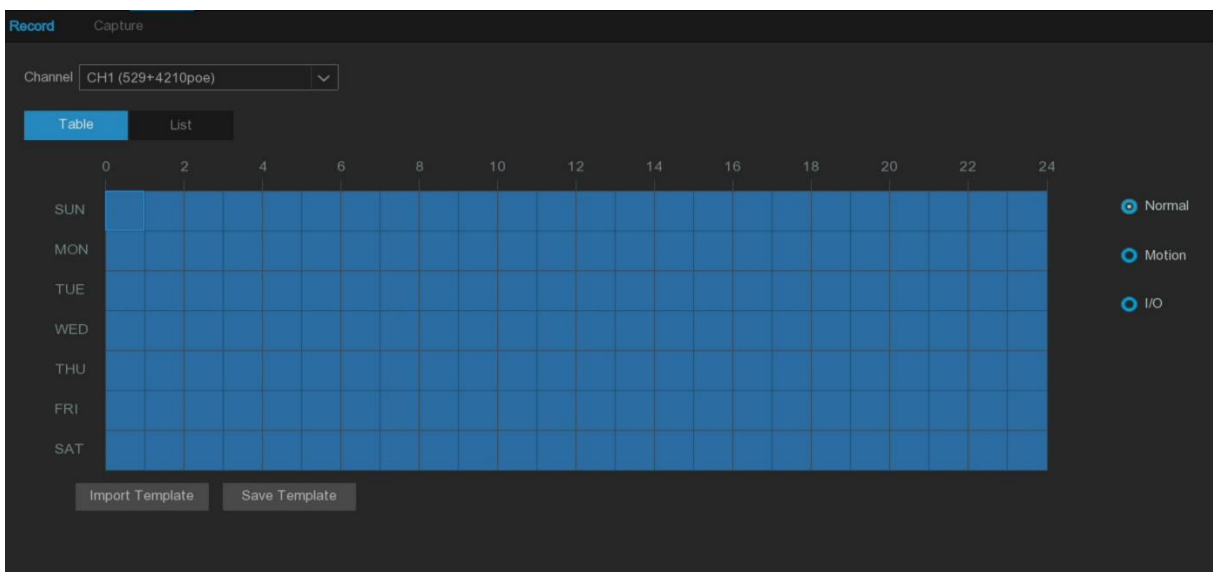

Channel: Select the channel to set video recording parameters.

Normal: Indicates the recording time period of normal video recording settings under the current channel.

Motion: Indicates the recording period of the motion detection video setting under the current channel.

I/O: The recording time period representing I/O alarm video settings in the current channel.

No Record: The time area marked as black in the table form indicates that no recording is scheduled for that session.

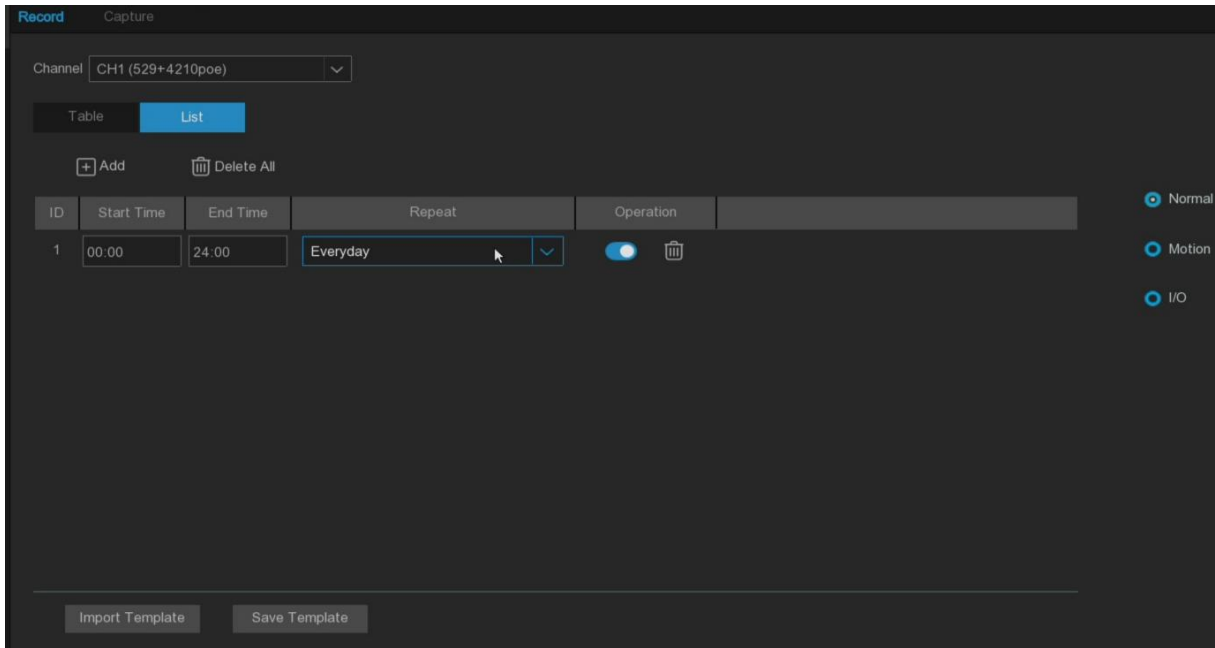

Table / List: The schedule table is presented in a table or a list form.

Select the Table form, drag or tick the corresponding time period in the table to set the corresponding time schedule.

Select the List form and set the corresponding time schedule by manually adding the rules and entering the start and end time periods.

Add: Add a schedule rule.

Delete All: Delete all schedule rules.

Start Time: Set the schedule rule start time.

End Time: Set the end time of the schedule rule.

Repeat: Set up the period during which the schedule rule takes effect.

Note: Up to 8 time periods are set. Each time period cannot be crossed or included.

Import Template: Import the custom or system default schedule template.

Edit: Edit the schedule template, you can modify the template name and the specific schedule rules.

Delete: Delete the schedule template.

Note: The system supports 7x24 and 5x24 schedule templates by default, which cannot be editable and deleted.

Save Template: Save the schedule template, you can save the currently set schedule rules as a custom template, which can be imported in the other schedule setting page.

5.2.1.2 Capture schedule

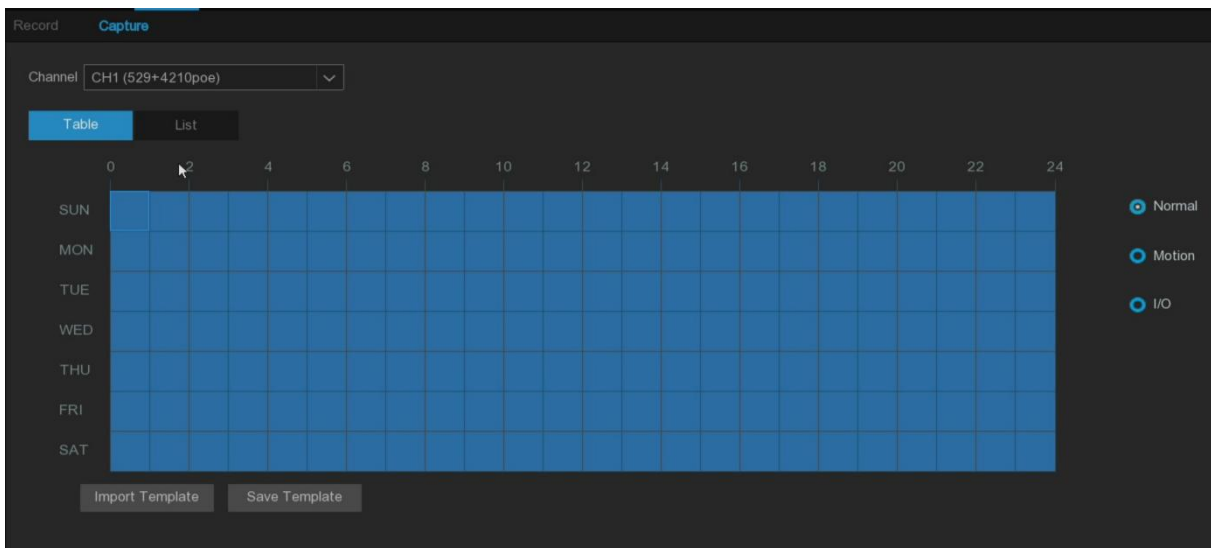

Channel: Select the channel to set its automatic capture parameters.

Normal: Indicates the time period under the current channel.

Motion: Indicates the time period of the motion detection and capture under the current channel.

I/O: Represents the time period when the I/O alarm capture under the current channel.

No Record: The time area marked as black in the table form indicates that no recording is scheduled for the record. Detailed settings refer to [5.2.1.1 Record Schedule](#).

5.2.2 Storage

5.2.1 Hard Disk

This menu is used to manage and configure internal or external hard disk drives of the NVR, such as formatting disks, configuring record parameters and disk test.

Note: The models supporting four hard disk bits and above will display the Slot.NO bar, the information corresponding to the hardware SATA slot number.

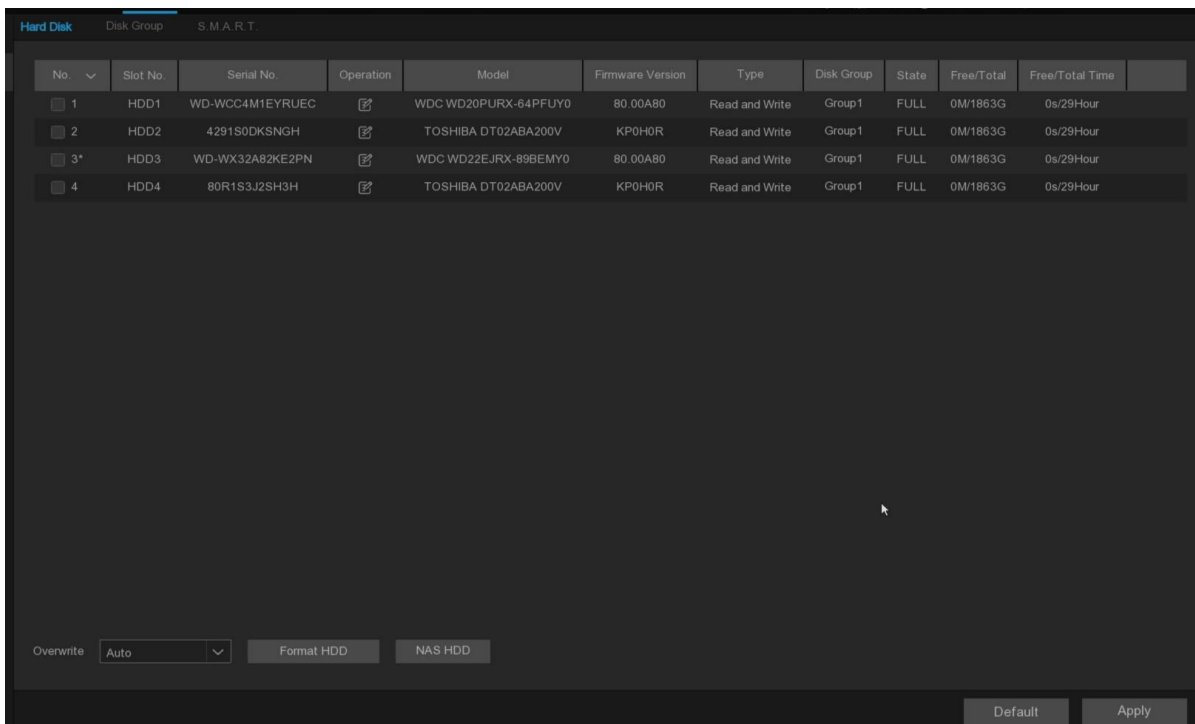

Format HDD: Select the hard disk that needs to be formatted, click **Format HDD** button, and perform the formatting operation after checking the password from the pop-up menu.

NAS HDD: Support the configuration of network hard disk for recording and capture storage. You need to create a storage partition on the network hard disk in advance and successfully connect the network hard disk on the device through the network.

(**Note:** AI database, license plate database and video prompts file only is stored in local HDD drive.)

The screenshot shows a configuration window titled "NAS HDD". It has a dark background with light-colored text and input fields. The fields are:

- Mounting Type:** A dropdown menu currently showing "NFS".
- Server IP:** A text box containing "000.000.000.000".
- Directory Name:** An empty text box.
- Capacity:** A text box containing "Default", followed by "GB" to its right.

 At the bottom of the window, there are two buttons: "Test" and "Add".

Mounting Type: Choose the mounting type from NFS and SMB/CIFS. You would need to input the account name and password of NAS if you choose SMB/CIFS.

User Name: Enter the NAS account name (In NFS mode, it is in an unselectable state)

Server IP: Enter the IP address of NAS storage.

Password: Enter the NAS password (In NFS mode, it is in an unselectable state)

Directory Name: Input the directory name on which you want to save your recording data.

Disk Size: Set the capacity size of NAS storage.

Test: Click to test the connection to NAS storage.

Add NAS HDD: Click to add NAS storage.

Overwrite: This instructs your NVR to overwrite the oldest video files as the hard drive becomes full. You also have the option of selecting the amount of days for recordings to be kept before they are overwritten. For example, if you choose the option 7 days then only the last 7 days' recordings are kept on the HDD.

To prevent overwriting any old recordings, select **OFF**. If you have set Off on this feature, please check the HDD status regularly to make sure the HDD is not full. Recording will be stopped if HDD is full. We recommended leaving the **Auto** selection as this prevents your NVR from running out of storage space.

Record on ESATA: This menu only displayed when your NVR is coming with an E-SATA port on the rear panel and your E-SATA HDD has been connected to the NVR already. It will allow to record the video to external E-SATA HDD to enhance your HDD capacity. If the E-SATA recording function is enabled, E-SATA backup function will be disabled.

If your NVR supports to install multiple hard disks and more than 1 hard disk is installed in your NVR, the edit button  will be appear in your system, you can click it to edit the HDD as below picture.

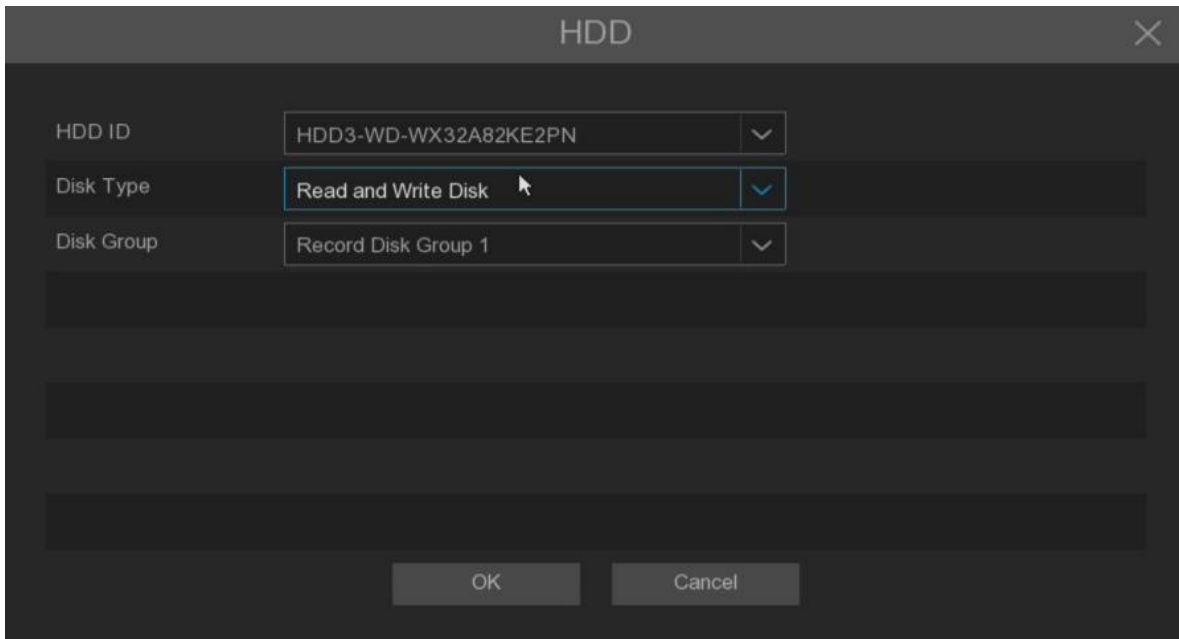

Disk Type: You can set the hard disk to be Read Write, Read Only, or Redundant.

- **Read Write** type is the normal status for an HDD to save recordings or search recordings to play. If all the installed hard disks are set to Read Write mode, the NVR will save recordings to the hard disks sequentially.
- To prevent important video data from being overwritten during cyclic recording, the hard drive disk can be set as **Read Only** type. New recordings will not be able to be saved to this read-only disk. You can still search and play recordings from this read-only disk.
- A **Redundant** hard disk can be used to save the same recordings as what is saved to the Read Write hard disk(s). When a redundant disk is set, the system can save recordings in parallel to both the Read Write hard disk and the redundant hard disk in case of hard disk failure.

Note:

1. Redundant disk supports to save mainstream recording only.

2. If the disk type has been changed, the hard disks might be unmounted and offline.

Please wait a while till the hard disks get mounted again.

3. For NVR with more than 32 channels, only Read Write and Read Only types are available

Disk Group: You can set the disks into different disk group for recording.

5.2.2 Disk Group

If your NVR supports installing multiple hard disks, and more than one hard disk is already installed in your NVR, you will see this menu. With the Disk Group function, you can assign different cameras to different hard disks for recording, in order to reduce the loading on a single hard disk and extend the life of the hard disk. For example, record channels 1-16 to one disk group, and record channels 17-32 to another disk group.

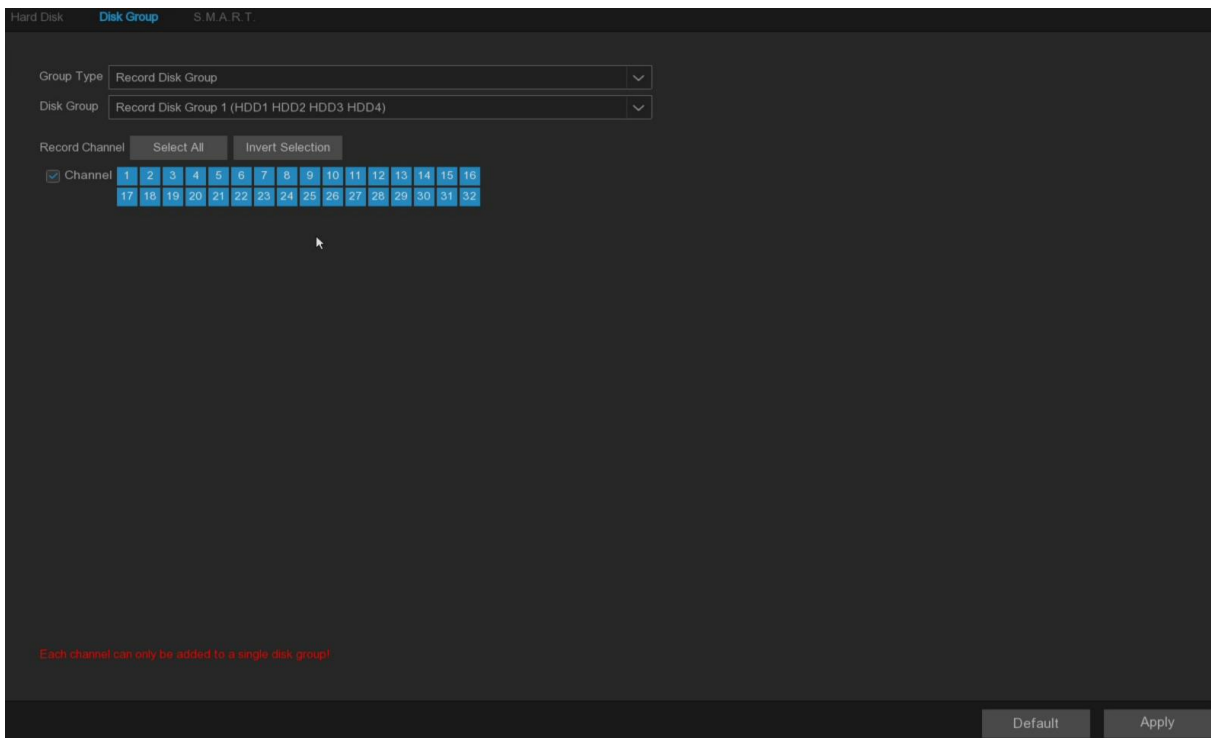

1. On the disk list page, click on the edit button  of the hard disk you want to configure, and then select its "Disk Type" and "Disk Group".

2. Go back to the "**Disk Group**" page, choose a Disk Group Type. If all the hard disks are set as Read Write mode, only Record Disk Group is available to choose here. If one or more hard disks are set as Redundant mode, Redundant Disk Group will be available to choose here.
3. Choose the "**Disk Group**".
4. Select the **Record Channel**. It indicates which camera(s) will be recorded and saved into the hard disk(s) in the selected group.

Click "**Apply**" to save your settings

Note: When the number of video channels configured by a single disk group exceeds 32, there may be a risk of video loss due to hard disk read and write performance. It is recommended that the number of video channels configured by a single disk group should not exceed 32.

5.2.3 S.M.A.R.T

This function can be used to detect and evaluate the running status of the hard disk in use, to detect risks in time and avoid data loss caused by hard disk failure.

Hard Disk Disk Group **S.M.A.R.T.**

HDD ID: Self-test Type:

Self-test State: Not detected Utility Time(d): 803

TEMP(°C): 40 Whole Evaluation: Passed

S.M.A.R.T. Info:

ID	Item	Status	Flags	Value	Worst	Threshold	Raw Value
0x1	Raw Read Error Rate	OK	21	200	200	51	0
0x3	Spin Up Time	OK	27	178	176	21	4083
0x4	Start/Stop Count	OK	32	99	99	0	1463
0x5	Reallocated Sector Count	OK	33	200	200	140	0
0x7	Seek Error Rate	OK	2e	200	200	0	0
0x9	Power-On Hours Count	OK	32	74	74	0	19272
0xa	Spinup Retry Count	OK	32	100	100	0	0
0xb	Calibration Retry Count	OK	32	100	100	0	0
0xc	Power Cycle Count	OK	32	100	100	0	809
0xc0	Power-Off Retract Count	OK	32	200	200	0	723
0xc1	Load/Unload Cycle Count	OK	32	200	200	0	1568
0xc2	HDA Temperature	OK	22	107	94	0	40
0xc4	Reallocation Count	OK	32	200	200	0	0
0xc5	Current Pending Sector Count	OK	32	200	200	0	0
0xc6	Offline Scan Uncorrectable Count	OK	30	100	253	0	0
0xc7	UDMA CRC Error Rate	OK	32	200	200	0	0

Self-check Type: There are three types available.

Short: This test verifies major components of the hard drive such as read/ write heads, electronics and internal memory.

Long: This is a longer test that verifies the above as well as performing a surface scan to reveal problematic areas (if any) and forces bad sector relocation.

Conveyance: This is a very quick test that verifies the mechanical parts of the hard drive are working.

Note:

When performing a test, your NVR will continue to work as normal.

If the hard disk S.M.A is found. R.T error, risk of missing recorded data, recommended to replace a new hard disk.





















5.3 Alarm

This menu can configure series of alarm linkage made by the system to the alarm signals when various alarms are triggered.

5.3.1 I/O alarm

5.3.1.1 Alarm Input

This page display and configure the enabling situation of all I/O alarm input sources and a series of alarm linkages after triggering alarms.

Alarm Input No.	Type	Enable	Settings	Edit
Local<-1	Normally-Close	Enable	Input	
Local<-2	Normally-Close	Enable	Input	
Local<-3	Normally-Open	Disable	Disable	
Local<-4	Normally-Open	Disable	Disable	
Local<-5	Normally-Open	Disable	Disable	
Local<-6	Normally-Open	Disable	Disable	
Local<-7	Normally-Open	Disable	Disable	
Local<-8	Normally-Open	Disable	Disable	
Local<-9	Normally-Open	Disable	Disable	
Local<-10	Normally-Open	Disable	Disable	
Local<-11	Normally-Open	Disable	Disable	
Local<-12	Normally-Open	Disable	Disable	
Local<-13	Normally-Open	Disable	Disable	
Local<-14	Normally-Open	Disable	Disable	
Local<-15	Normally-Open	Disable	Disable	
Local<-16	Normally-Open	Disable	Disable	
10_10_1_2<-1	Normally-Open	Disable	Disable	
172_20_58_6<-1	Normally-Close	Enable	Input	
10_10_8_8<-1	Normally-Open	Disable	Disable	
10_10_11_11<-1	Normally-Open	Disable	Disable	
172_20_58_34<-1	Normally-Open	Disable	Disable	

Default Apply

Edit: Click  button to open the configuration page, as shown in the below picture.

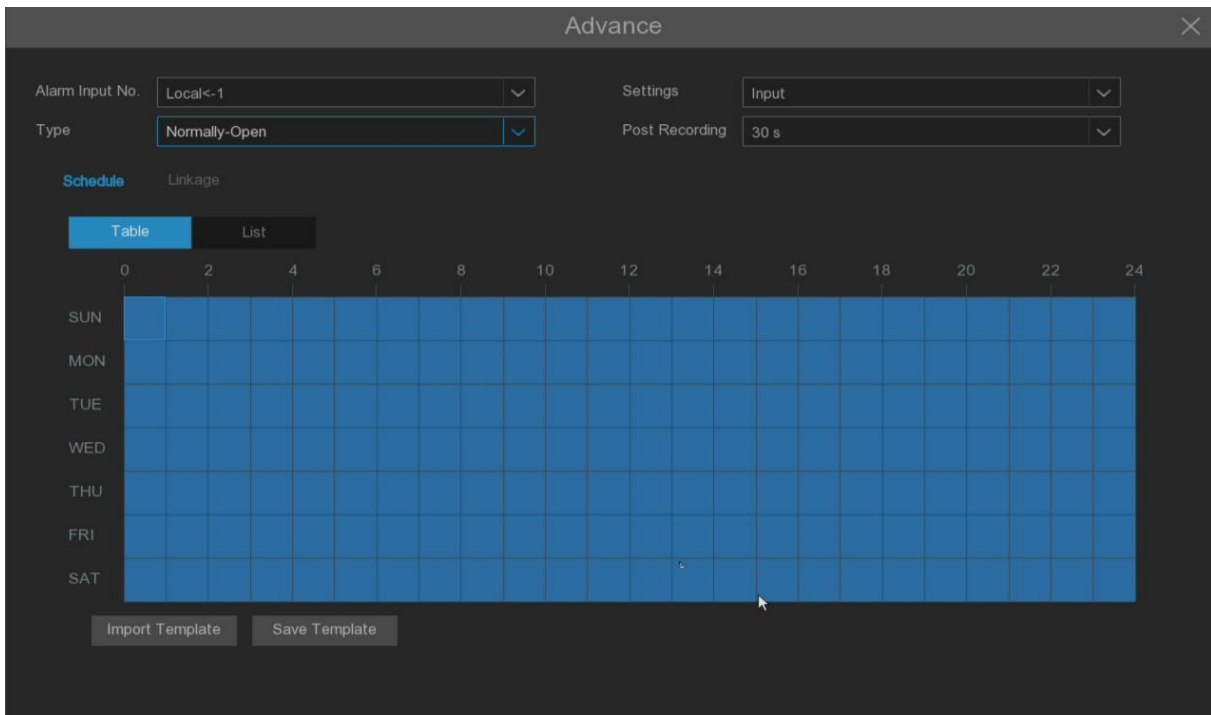

Alarm Input No.: Select the I/O alarm input source.

Type: Optional Normal-Open and Normal-Close, consistent with the type of access sensor.

Settings: With or not the I/O alarm input source.

Disable: Not enabled.

Input: Enable I/O alarm input, configure schedule and alarm linkage.

Post Recording: Set the duration of continuous NVR recording after the event occurs.

Schedule: Configure the time period of the current I/O alarm input source, and refer to

5.2.1.1 Record schdeule.

Linkage: Configure a series of alarm linkage after triggering the alarm.

Buzzer: Set whether the device will beep after the I/O alarm occurs for 10 seconds.

Show Message: Set whether the icon is displayed  on the real-time preview channel after the I/O alarm occurs.

Email: Set whether to send an email to the mailbox after the I/O alarm occurs.

Voice Prompts: Set whether to broadcast after I/O alarm occurs. Please refer to **5.3.4**

Voice Prompts.

Alarm Output: Set whether the linkage alarm output after the I/O alarm occurs.

Channel Record: Set the channel to be recorded after the I/O alarm occurs.

PTZ Linkage: Set whether the PTZ is linked after I/O alarm occurs.(High-Speed dome requiring access support can be linked).

Preset: Linkage the preset point, set the residence time of the preset point and the preset point. When the I/O alarm occurs, the linkage to PTZ will rotate to the set preset point.

Tour: Set the track cruise and set the track. When the I/O alarm occurs, it will cruise according to the set track cruise linkage to PTZ.

Pattern Scan: Set the pattern scan. When the I/O alarm occurs, it will cruise according to the set pattern cruise linkage to PTZ.

Disarming: Enabled and Local <-1 is supported only. When enabled, Local <-1 is only used to control whether to perform one-key disarming. Detailed setting of disarming parameters can refer to **5.3.7 Disarming**.

5.3.1.2 Alarm Output

When event alarm triggered and linked to alarm output, the execution schedule and duration of the alarm output can be configured on this page.

Alarm Output No.	Latch Time	Edit
Local->1	5 s	
10.10.1.2->1	5 s	
172.20.58.6->1	5 s	
10.10.8.8->1	30 s	
10.10.11.11->1	5 s	
172.20.58.34->1	5 s	
172.20.58.33->1	5 s	
172.20.58.28->1	5 s	
172.20.58.44->1	5 s	
172.20.58.32->1	5 s	
172.20.58.35->1	5 s	
172.20.58.24->1	5 s	
172.20.58.23->1	5 s	
172.20.58.36->1	30 s	
172.20.58.22->1	5 s	
172.20.58.43->1	5 s	
172.20.58.43->2	5 s	
172.20.58.41->1	5 s	

Edit: Click button to open the configuration page, as shown in the below picture.

Advance ✕

Alarm Output No. Latch Time

Alarm Status

Schedule

	0	2	4	6	8	10	12	14	16	18	20	22	24
SUN													
MON													
TUE													
WED													
THU													
FRI													
SAT													

Alarm Output No.: Select the alarm output source.

Latch Time: Set the duration of the alarm output.

Alarm Status: Display the current I/O alarm output status.

Schedule: Configure the time period of the current alarm output source. Referring to the 5.2.1.1 Record schdeule.

Trigger: Set the manual alarm, click the button to open and close I/O alarm.

5.3.2 Exception

This menu can configure the alarm linkage for NVR exception events.

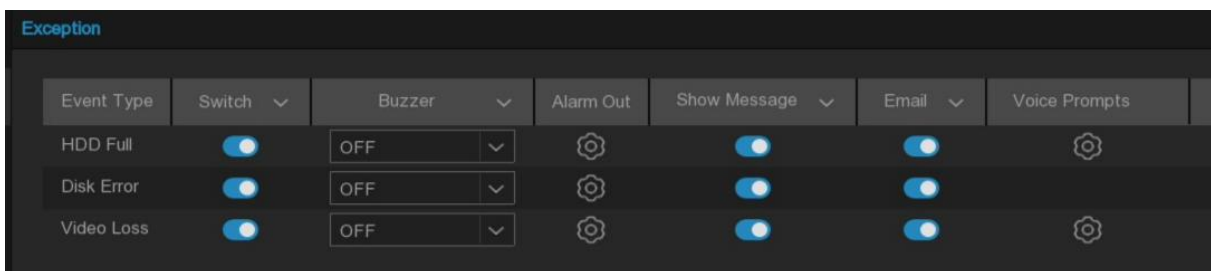

Event Type: There are 3 event types that your NVR will detect as exception.

HDD Full: The hard disk is full.

Disk Error: Hard drive error (While writing or hard drive is not initialized).

Video Loss: Video signal is lost (The channel is deleted or the channel is not correctly connected).

Switch: Enable or disable exception alarm.

Buzzer: When a detection event is triggered, you can enable the NVR's buzzer to provide an audible alert for a preset duration. Click the drop-down menu to select the desired time.

Alarm Out: If your NVR or IP camera supports connecting external alarm output devices, the system can send an alert notification to these devices.

Show Message: Set whether the icon or prompt language is displayed in the real-time preview interface after the event alarm occurs.

Email: Set whether to send an email to the mailbox after an event alarm occurs.

Voice Prompts: Set whether to broadcast after the event alarm occurs. Please, refer to 5.3.4 Voice Prompts.

5.3.3 Combined Alarm

The Combined Alarm function allows to set combination of two or more alarm types at the same time. The NVR will only trigger alarm when all of specified alarm types in the combination occur simultaneously. It will help minimize false alarms.

Combined Alarm								
+ Add a Combined Alarm								
Alarm Name	Switch	Configuration	Alarm Out	Record	Post Recording	Normal Linkage	Delete	
Customized Alarm 1	<input checked="" type="checkbox"/>			OFF	30 s			
Customized Alarm 2	<input type="checkbox"/>			OFF	30 s			
Customized Alarm 3	<input type="checkbox"/>			OFF	30 s			
Customized Alarm 4	<input type="checkbox"/>			OFF	30 s			
Customized Alarm 5	<input type="checkbox"/>			OFF	30 s			
Customized Alarm 6	<input type="checkbox"/>			OFF	30 s			
Customized Alarm 7	<input type="checkbox"/>			OFF	30 s			
Customized Alarm 8	<input type="checkbox"/>			OFF	30 s			
Customized Alarm 9	<input type="checkbox"/>			OFF	30 s			
Customized Alarm 10	<input type="checkbox"/>			OFF	30 s			
Customized Alarm 11	<input type="checkbox"/>			OFF	30 s			
Customized Alarm 12	<input type="checkbox"/>			OFF	30 s			
Customized Alarm 13	<input type="checkbox"/>			OFF	30 s			
Customized Alarm 14	<input type="checkbox"/>			OFF	30 s			
Customized Alarm 15	<input type="checkbox"/>			OFF	30 s			
Customized Alarm 16	<input type="checkbox"/>			OFF	30 s			

+ Add Combined Alarm: Add a new set of combined alarms, and support up to 15 new groups.

Alarm Name: Set the name of the combined alarm.

Switch: Tick to enable the combined alarm.

Alarm Out: Set whether the alarm output is linked after the combined alarm occurs.

Record: Set the channel to be recorded after the combined alarm occurs.

Post Recording: Set the duration of continuous NVR recording after the combined alarm occurs.

Delete: Delete the combination of the alarm.

Nomal Linkage: Set up the routine alarm linkage after the combined alarm occurs, with the following options.

Buzzer: When detection event is triggered, you can enable the NVR's buzzer to provide an audible alarm for a preset duration. Click the drop-down menu to select the desired time.

Email: Set whether to send an email to the mailbox after the combined alarm occurs.

Voice Prompts: If your NVR is connected to a speaker, you can select a customized voice alert to play when a detection event triggers. See section [5.3.4 Voice Prompts](#) for adding custom voice file.

Pop-Up: Set whether the window prompts automatically after the combined alarm occurs.

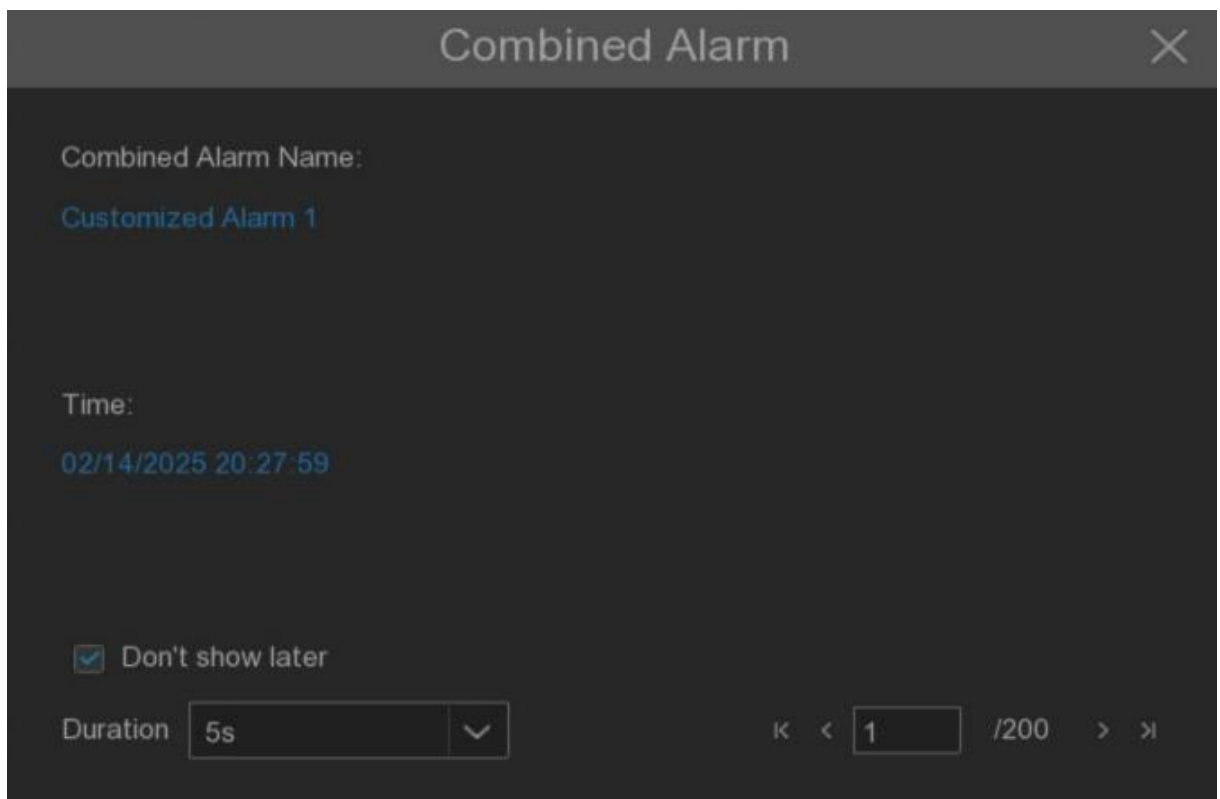

Don't show later: Tick this option do not automatically popup when trigger combined alarm.

Duration: Set the continuous display time after the popup prompt. (**Note:** If the mouse is in the display area, the continuous display time will pause until the mouse moves out of the display area.)

Configuration: Open the configuration page of the combined alarm.

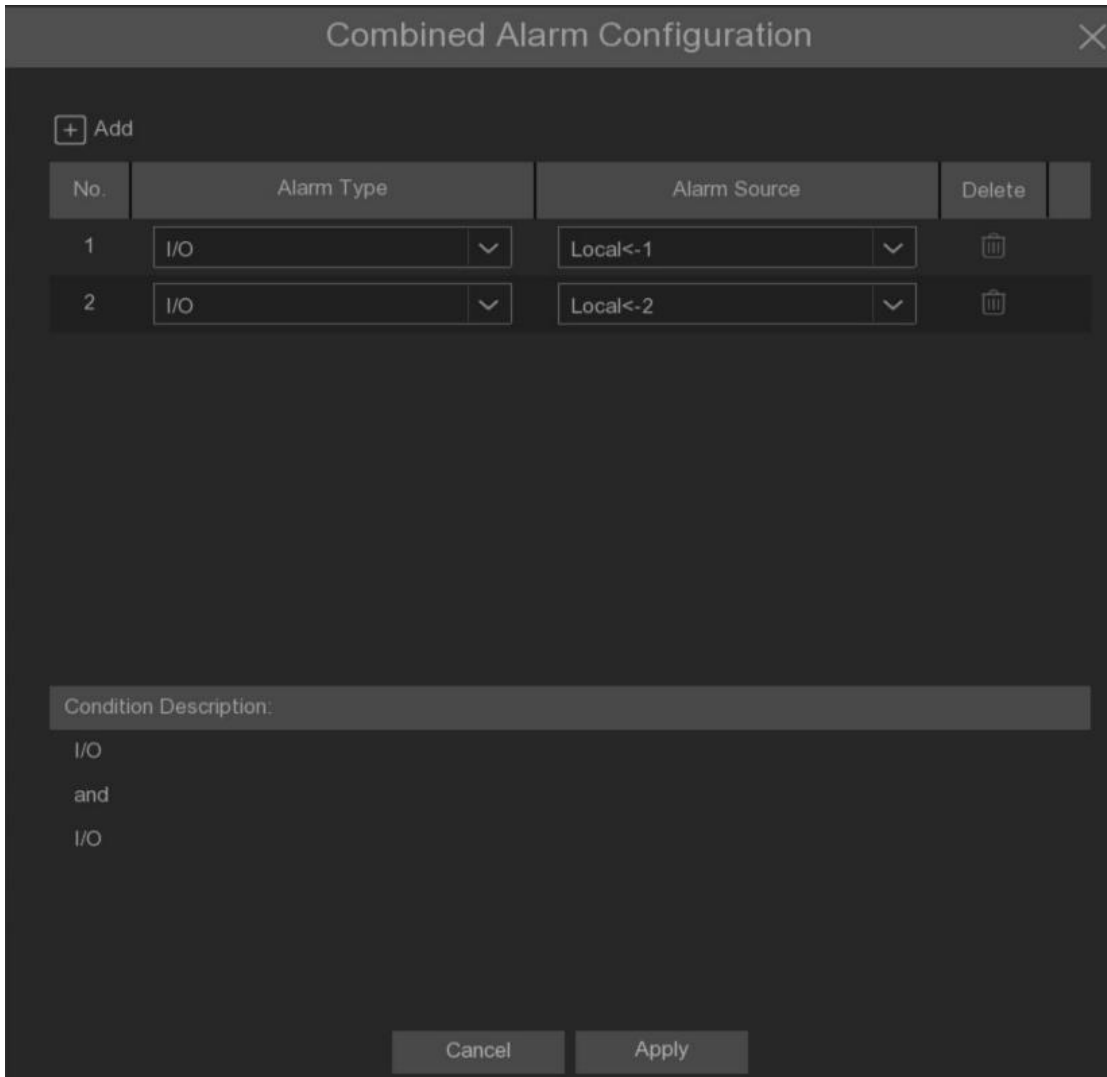

Add: Add new combined alarm event.

Alarm Type: Select the alarm event type.

Alarm Source: Select the channel that supports the event type.

Delete: Delete the combined alarm event.

If the added combined alarm event is not enabled, there will be a red prompt after clicking

[Apply](#) button. Click [settings](#) button to open the setting page of the alarm event.

5.3.4 Voice Prompts

This function is used for receiving the alarm and voice prompts device for linkage after the alarm occurs, and automatically or manually playing the audio related to the field "intrusion" behavior on the scene.

5.3.4.1 Voice File Management

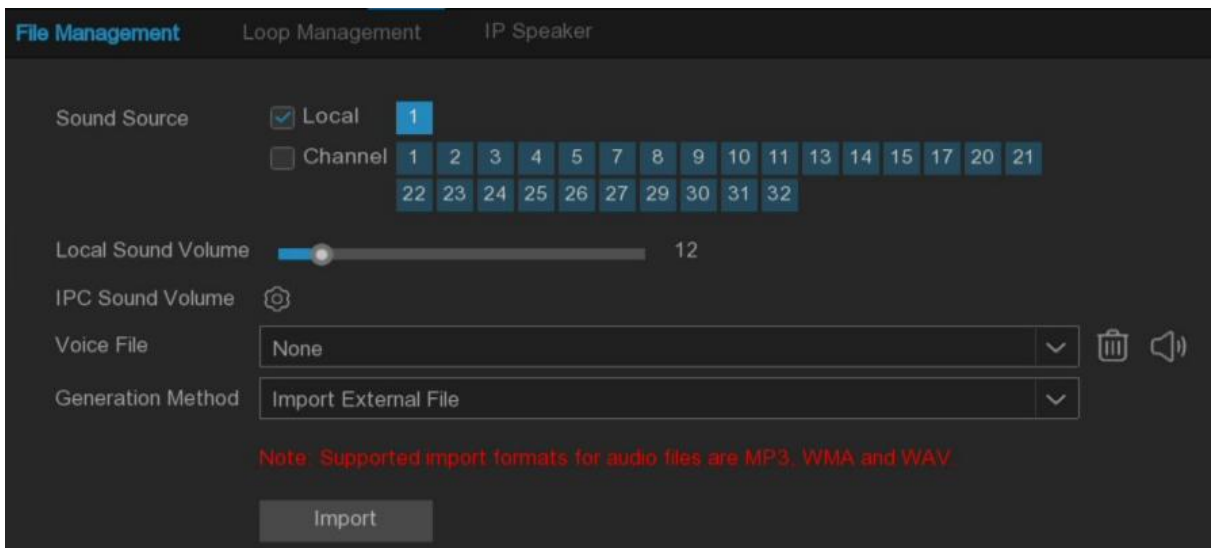

Click [Import](#) to import audio file, support two kinds of audio import methods, including Import External File, Text-to-Speech (Internet) .

Import External File: Local import (Support import MP3、WMA、WAV format of the audio file).

Text-to-Speech(Internet): Web server translation (Local import of text content that needs to be translated, sent to the network server to translate into audio files, and automatically save to the local hard disk storage) .

The text import box has a maximum input length of 200 bytes. **Import File:** Import audio files,

The face database and license plate database allow each file size of 1~500K, Non-face database and license plate database allow each file size of 1~5M.

Import of the voice prompts audio is available in **Voice File** to select.

Voice Prompts support 2 kind of methods, Local and IP channels.

Local Audio Volume: Adjustable NVR local prompts volume output size.

IPC Sound Volume: Set  the voice prompts volume output size of the camera channel.

Local: Local broadcast (When selecting this mode of broadcasting, the device side should be connected to the audio output device) .

Channel: The IP camera broadcast (This choice of broadcasting mode requires the camera program to have a voice broadcast function, while the camera side supports audio output) .

Voice Prompts setting by time period: An alarm type can support a voice prompts for up to 12 time periods, with no conflict between the start and end time of any time period.

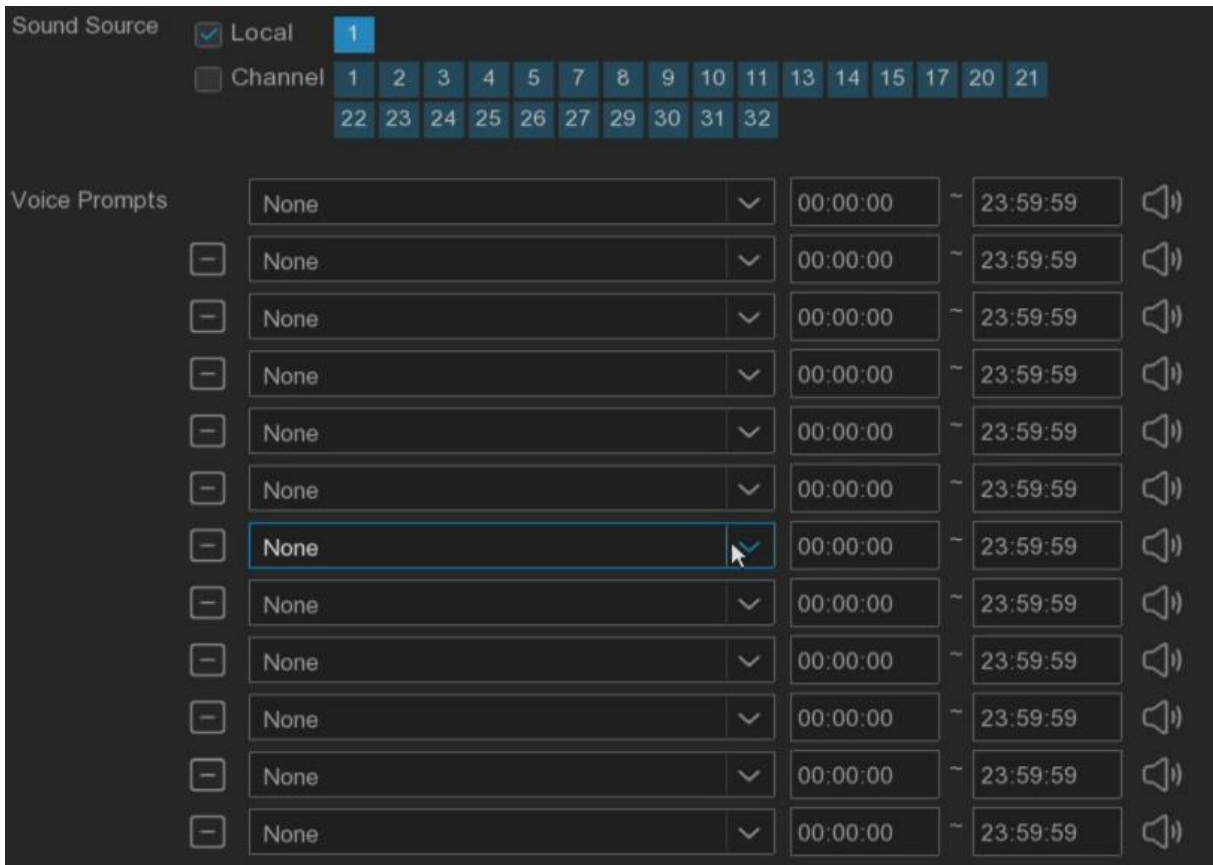

Voice prompts setting based on face recognition: this function is to realize the face recognition, the system collects the alarm signal and the voice broadcast equipment for linkage, and automatically plays the associated audio to the scene "intrusion" object. (Note: Audio imported based on face recognition allow and block list can only be used for the

associated.).

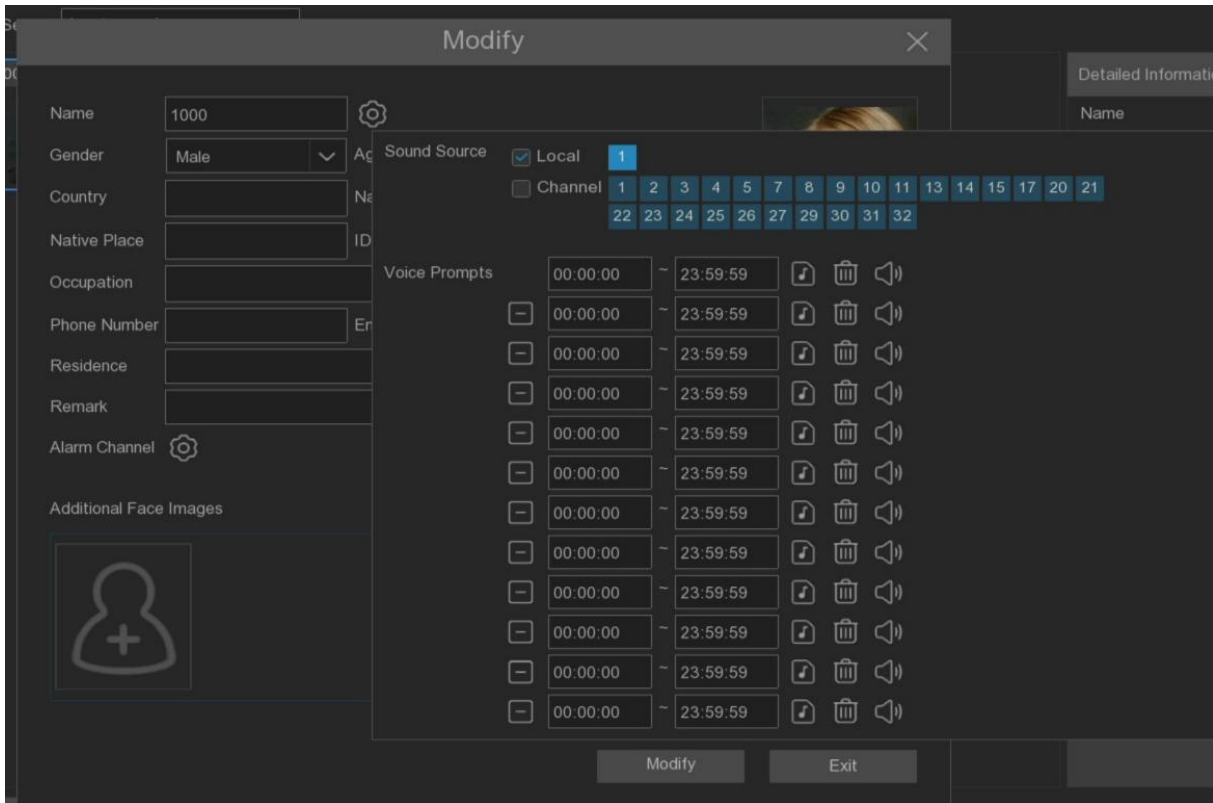

That is, when trigger face detection will be voice prompt.

5.3.4.2 Loop Management

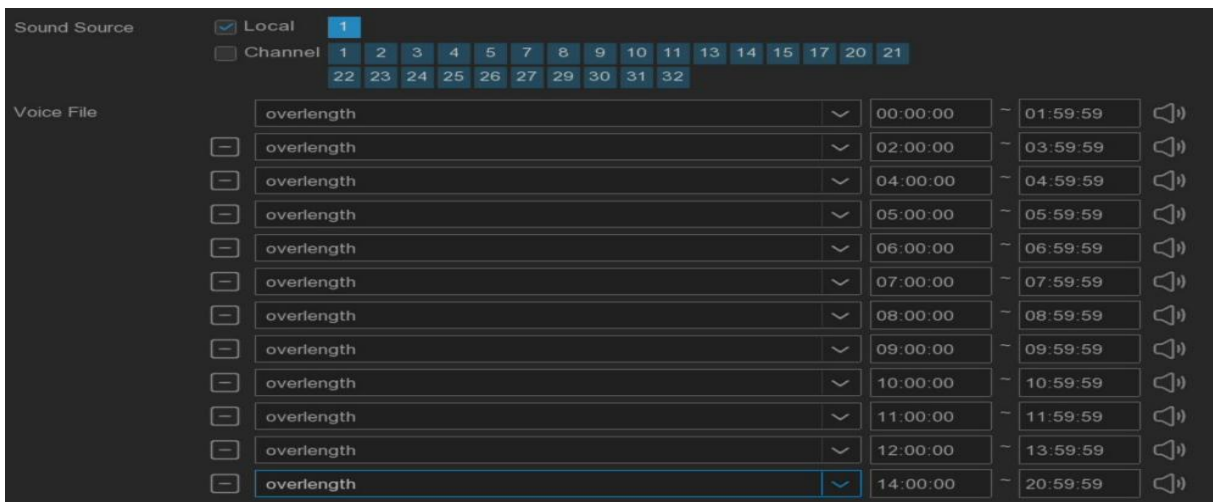

Voice File: After selecting the audio file and setting the time period, the selected audio file will be played repeatedly, and the voice broadcast can be set for up to 12 time periods.

Local: Local broadcast (when choosing this broadcast mode, the device side should be connected to the audio output device).

Channel: Network camera broadcast (choosing this broadcast mode requires the camera program with voice broadcast function, and the camera side supports audio output).

5.3.4.3 IP Speaker

On this page, IP Speaker can be added and choose to broadcast to IP Speaker for voice prompts configuration.

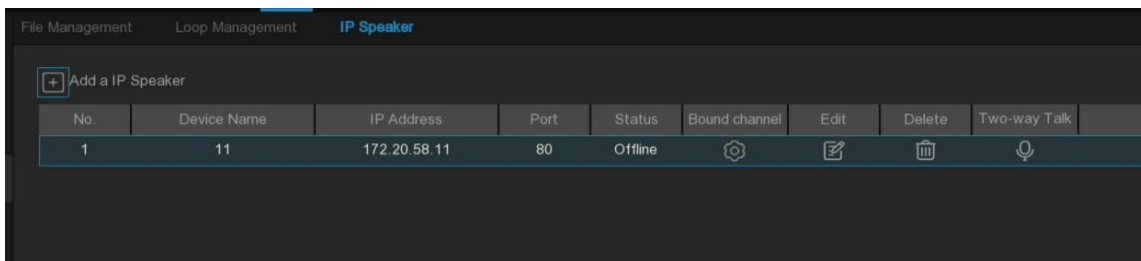

Add IP Speaker: Press  button to add IP Speaker.

Device Name: Set the name of the added IP Speaker.

IP Address: Enter IP address of the IP Speaker.

Port: Enter the port number for the IP Speaker.

Username: Enter the user name of the IP Speaker.

Password: Enter the IP Speaker password.

Bound Channel: Set the channel of IP Speaker binding, and use RXCamView/Cybvu application to click the IP Speaker intercom  to show the preview of the bound channel.

Edit: Edit  IP Speaker.

Delete: Edit  button to delete IP Speaker.

Two-way Talk: Click  button to match the device with the IP Speaker.

5.3.5 Deterrence

The menu can be configured with warming light, red and blue lights, and alarm deterrent parameters of camera channels(Access camera to support deterrence).

5.3.5.1 White light and Warning light

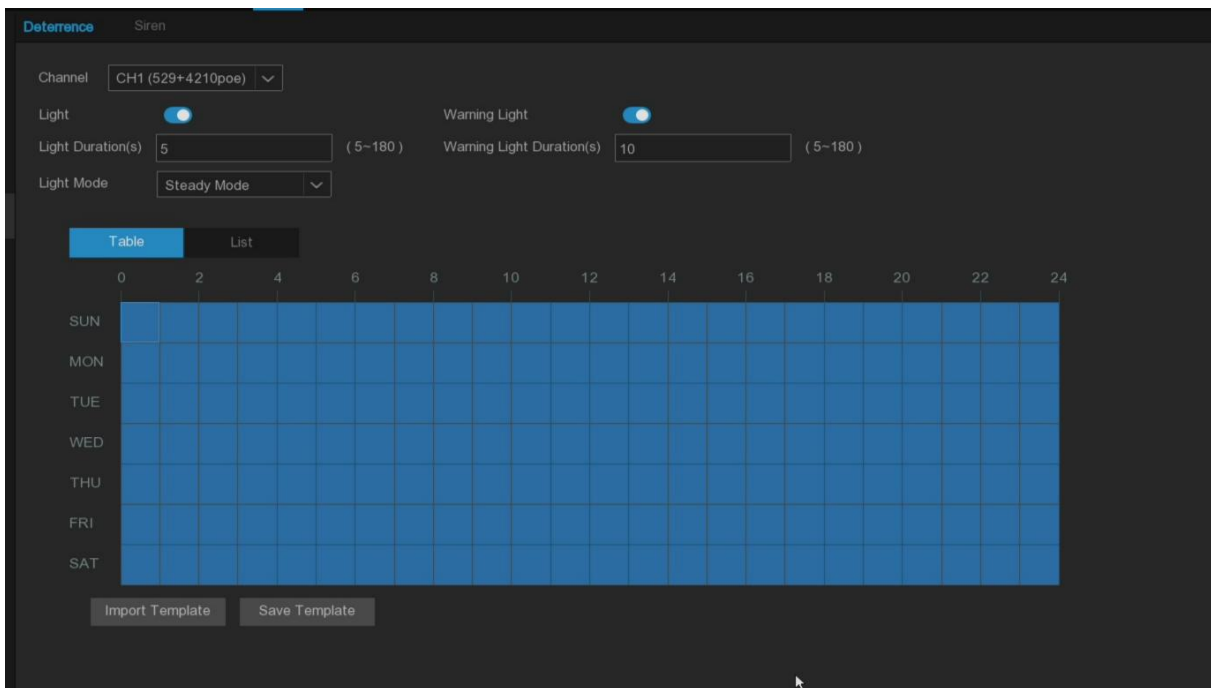

Channel: Select camera channel.

Light: Enable or disable white light.

Light Duration (s): Set the duration of the white light.

Light Mode: Set the white light mode, support **Steady Mode** and flicker mode **Flashing Mode**.

Flashing Frequency: The flashing frequency of the warming light, there are high, medium and low three levels are optional.

Warning Light: Enable or disable the red and blue light deterrent switch.

Warning Light Duration (s): Set the duration of red and blue light.

Schedule: For the installation of white light and red and blue lights, the schedule [5.2.1.1 Record Schedule](#).

5.3.5.2 Siren

If the camera connected to the device has a built-in speaker, the parameters related to the alarm sound can be set.

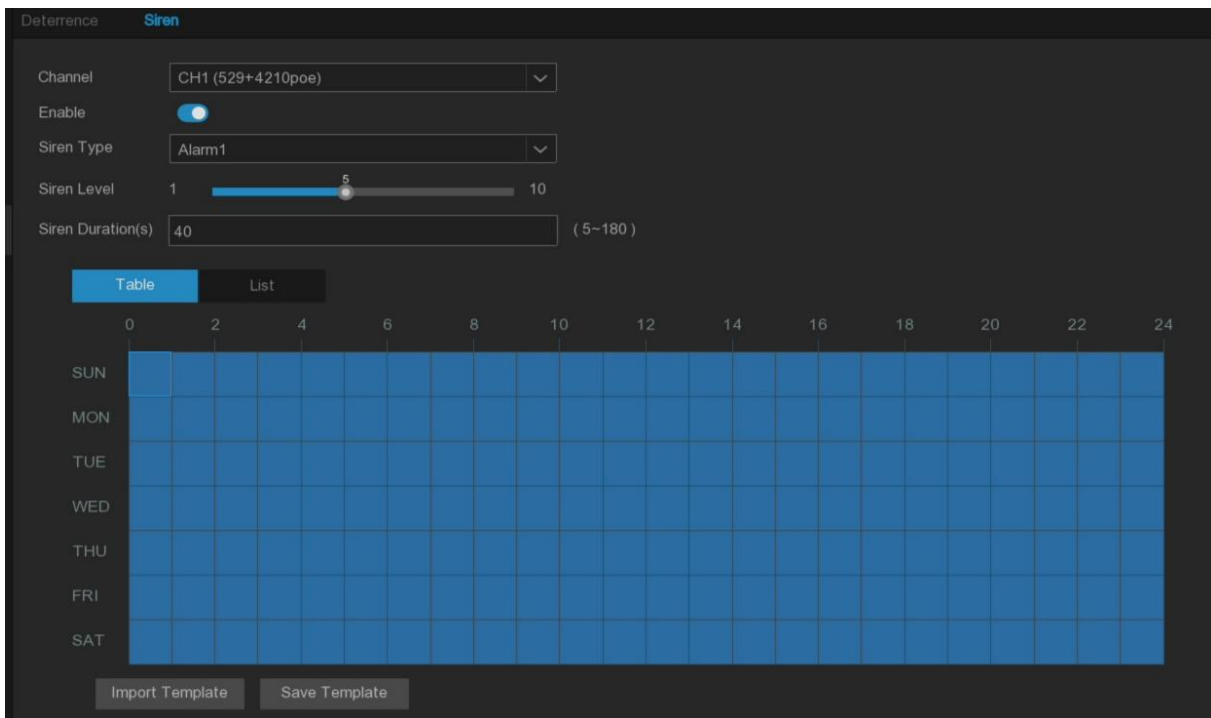

Channel: Select the camera channel.

Enable: Toggle to enable or disable the siren function.

Siren Type: Used to select the siren audio file. Depending on the model, the available alarm audio options may vary. Some models only allow you to select the built-in system alarm audio, while others allow you to upload up to three custom audio files. To use a custom audio file, select User-defined, and then upload the Pre-prepared audio file from a USB drive. The system supports importing PCM and WAV audio file formats. The imported audio

file's sampling rate should not exceed 8000Hz, and the file size should not exceed 256KB. Once a custom audio file is selected, a Delete button will appear on the right side, allowing you to remove the current audio file.

File Name: Siren Type Select the User-defined option, Enter the file name and click on the right Import button select a custom audio file for importing the U disk.

Siren Level: Used to set the siren volume level, which ranges from 1 to 10. The higher the level is, the louder the volume is.

Siren Duration(s): Used to set the siren duration. You can adjust the value between 5 to 180 seconds.

Schedule: If the IP camera is connected to the NVR via the HTTP port, you can click the [Schedule](#) button to open the setting page.

Detailed information about Siren refer to [5.2.1.1 Record Schdeule](#).

5.3.7 Disarming

Using the one-key disarming function, you can combine it with schedules to suppress alert behaviors for detected alarm events during specific time periods.

Note:

1. Exception alarm and Combined Alarm combined alarm linkage are not under disarming control.
2. One-click disarming enabled or disabled, it will not synchronize the disarming switch of the page.

3. The one-click disarming function has the highest priority. After the one-click disarming is enabled, the disarming switch configuration status on the Disarming page will be ignored to ensure the immediacy of the one-click disarming commands.
4. Detailed information of disarming system refer to chapter [5.3.1.1 Alarm Input](#).

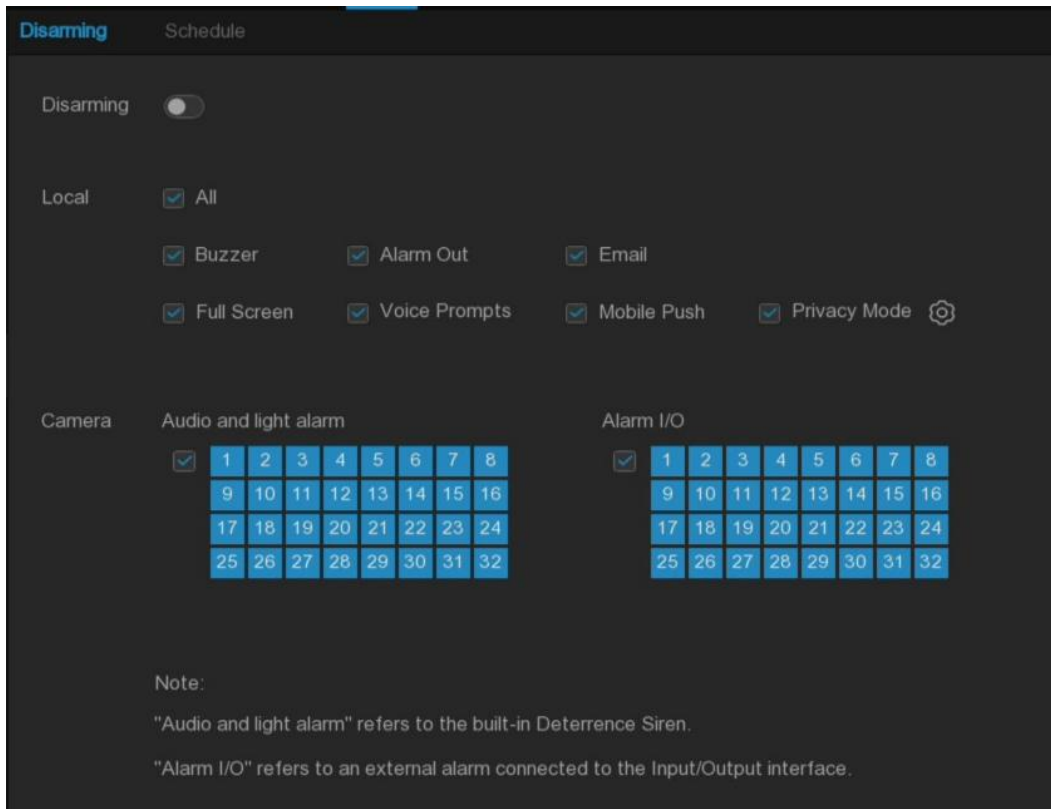

Disarming: Set to enable or disable the one-click disarming function.

Local: The NVR local alarm linkage type.

All: Select all types or empty all types.

Buzzer: Enable to disable the buzzer when an alarm is triggered while one-click disarming is enabled.

Alarm Out: Enable to disable external alarm output when an alarm is triggered while one-click disarming is enabled.

Show Message: Enable to prevent alarm messages from displaying on the preview page when a detection event triggers while one-click disarming is enabled.

Email: Enable to prevent the NVR from automatically sending emails when an alarm is triggered while one-click disarming is enabled.

Full Screen: Enable to prevent channels configured for full-screen mode from entering full-screen on the preview screen when triggering an alarm while one-click disarming is enabled.

Voice Prompts: Enable to disable voice prompts on channels configured for voice prompts when an alarm is triggered while one-click disarming is enabled.

Mobile Push: Enable to prevent the device from pushing alarm information to the mobile app(RXCam View and Cybvu) When alarm is triggered while one-click disarming is enabled.

Privacy Mode  : Enable disarming function, click **Privacy Mode**, the configured channel will disable the privacy mode.

Camera: Camera alarm linkage type.

Audio and light alarm: Enabled disarming function , if the camera in the channel supports red and blue lights, white light and siren , red and blue light, warning ligh or siren won't resonse when tirgger alarm.

Alarm I/O: Enabled disarming function, If the camera in the channel supports I/O alarm input /output.The I/O alarm input or output does not take effect.

Schedule: Configure the time periods when disarming is enabled. Detailed settings of the schedule table can be referred to [5.2.1.1 Record Schdeule](#).

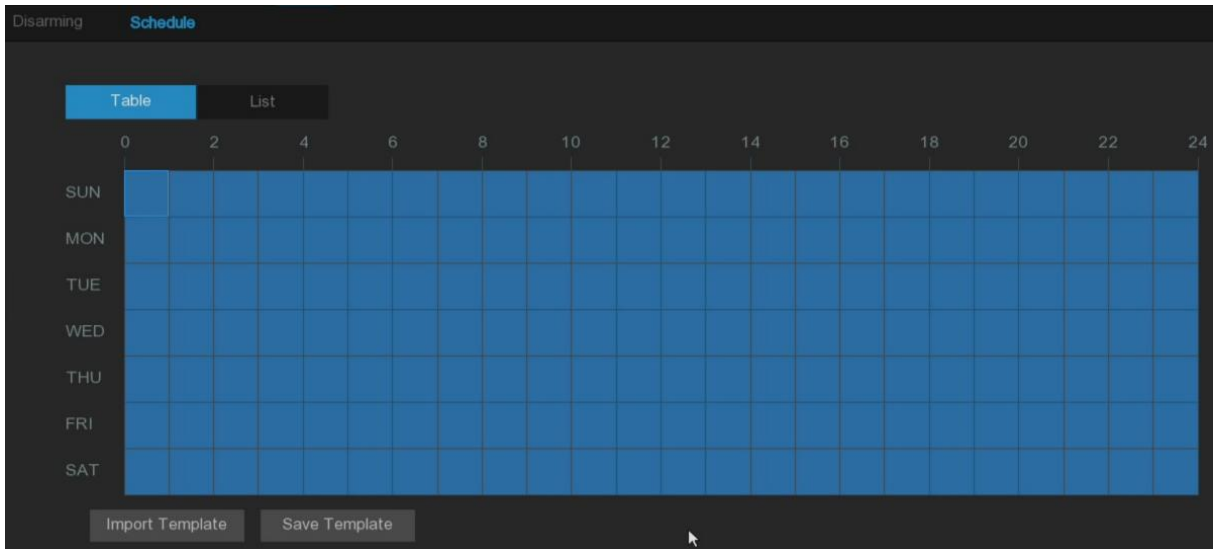

5.4 Event

5.4.1 Event Settings

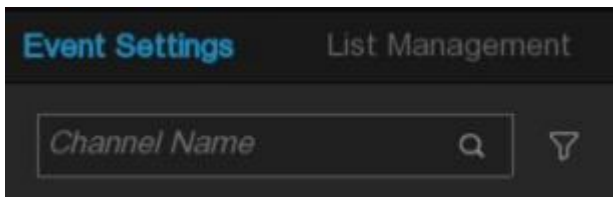

The user can easily enter the channel name of the camera through the input box to quickly locate the desired configured camera channel. Moreover, with the filter function button, the user can quickly screen all camera channels with this event type enabled.

5.4.1.1 Face detection

This menu allows to set parameters related to face detection.

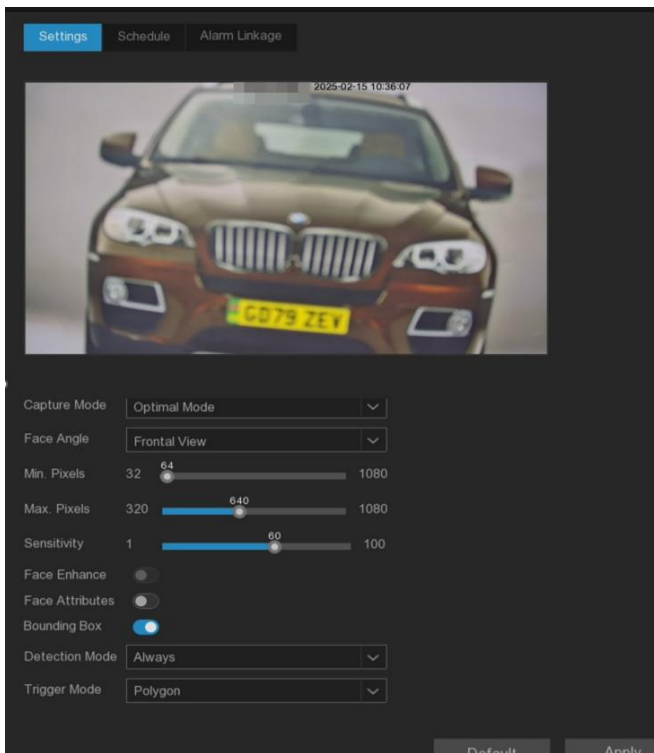

Capture Mode: Snapshot mode, with **Optimal Mode** (From the appearance of the face to the disappearance, choose the best quality picture and push). **Real-time Mode** (push once when the face appears, push once again when it disappears) and **Interval mode** (custom push time and interval).

Snapshot Qty: In interval mode, set the number of snapshots to push for each detection target in interval mode.

Capture Interval: Set the frequency of pushing snapshots of detection target in interval mode.

Face Angle: Set the angle of detection, including Front View mode, Multi-angle mode and User-defined angle mode.

- **Front View:** Only detects frontal/forward-facing faces.
- **Multi-angle:** Detects faces at multiple angles.
- **User-defined:** Customize the angle ranges for roll (rotation), pitch (vertical tilt), and yaw (horizontal pan) that faces should be detected.

Roll Angle: At User-defined mode, set the range of face rotation.

Pitch Angle: At User-defined mode, set the range of face pitch.

Yaw Angle: Set the range of face horizontal flip at custom angles.

Picture Quality: Set the image quality from 1 (lowest) to 100 (highest).

Frontal view/Multi-angle: Reset angle settings to defaults for frontal and multi-angle modes.

Min.Pixels: Set the minimum recognition pixel box, the face should be larger than the set pixel to be recognized.

Max.Pixels: Set the maximum recognition pixel box, the face should be smaller than the set pixel to be recognized.

Sensitivity: Set detection sensitivity level from 1-100. The larger the value, the easier it is to trigger.

Face Enhance: Enhance for better recognition of moving faces, may lower overall picture quality.

Face Attributes: After enabling this feature, the system will record the captured facial features, such as whether the person is wearing a mask or glasses, etc. Subsequently, when you search, you may be able to use these features to filter. This feature is only supported by some models, and due to product performance limitations, the recognized facial features may not be completely accurate.

Bounding Box: When enabled, a green bounding box will be displayed on the images, outlining and identifying detected targets. This aids in quickly locating and recognizing captured objects of interest.

Detection Mode: This setting determines the method used to detect targets within the camera's field of view. There are two modes available, please choose according to your specific needs.

- **Hybrid Mode:** In this mode, both static and moving targets are detected. It combines detection of both stationary objects and those in motion. Hybrid mode is beneficial in scenarios where both static and moving objects may be of interest for surveillance.
- **Motion Mode:** This mode exclusively detects moving targets within the frame. It focuses solely on identifying objects in motion, ignoring stationary elements.

Trigger Mode: Used to set the area and path for triggering target detection, it allows you to customize the area or path that triggers detection, enabling the system to focus on the specific areas and movement paths you are concerned about.

Rectangle: In this mode, you can draw a rectangular area as the detection area. Any targets entering this area will be detected and trigger the corresponding alarms or actions.

Detection Area: For Rectangle mode, set the detection area. You can either select Full Screen detection, or choose User-defined to adjust the size of the quadrilateral detection area.

Rule Type: Under the Line mode, you need to draw a line inside the preview area, and set the crossing direction Rule Type (A->B or B->A) so that when a face crosses the line according to the set rule, it will be detected and trigger a response - suitable for scenarios requiring monitoring of targets crossing a certain path or boundary line.

5.4.1.2 Pedestrian and Vehicle detection

This menu allows you to set parameters related to detect pedestrian and vehicles.

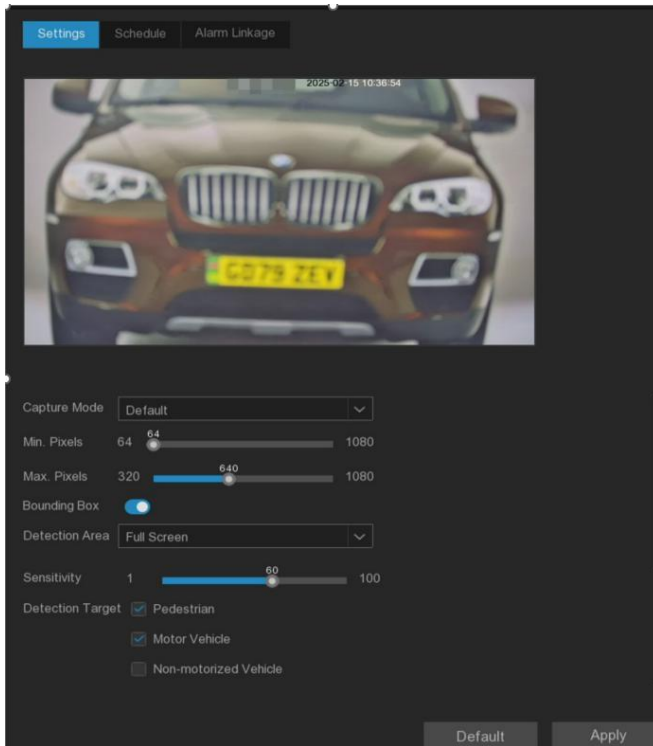

Capture Mode: Used to set the method for capturing snapshots when a detection target is identified.

- **Default Mode:** Select the best quality picture to push during the time from when the detection target appears to when it disappears.
- **Real-time Mode:** Push once when the detection target appears and again when it disappears.

Snap Qty: In the interval mode, Set the number of snapshots to push for each detection target in interval mode.

Capture Interval: Set the frequency of pushing snapshots of detection target in interval mode.

Min. pixels: Set the minimum identification pixel box, the person and vehicle should be larger than the set pixel to be identified.

Max. Pixels: Set the maximum recognition pixel box, the person and vehicle should be smaller than the set pixel to be identified.

Sensitivity: Set the sensitivity level, ranging from 1 to 100. The higher the value, the more easily it will be triggered.

Detection Target: Choose the detection target object. You can select from Pedestrian, Motor Vehicle, and Non-motorized Vehicle.

Detection Mode: This setting determines the method used to detect targets within the camera's field of view. There are two modes available, please choose according to your specific needs.

- **Hybrid Mode:** In this mode, both static and moving targets are detected. It combines detection of both stationary objects and those in motion. Hybrid mode is beneficial in scenarios where both static and moving objects may be of interest for surveillance.
- **Motion Mode:** This mode exclusively detects moving targets within the frame. It focuses solely on identifying objects in motion, ignoring stationary elements.

Bounding Box: When enabled, a green bounding box will be displayed on the images, outlining and identifying detected targets. This aids in quickly locating and recognizing captured objects of interest.

Detection Area: Used to set the area for triggering target detection, it allows you to customize the area, enabling the system to focus on the specific areas you are concerned about. You can either select Full Screen detection, or choose User-defined to adjust the size of the quadrilateral detection area.

5.4.1.3 License Plate Detection

The License Plate detection function utilizes video analytics to detect and recognize the license plates of vehicles passing through the camera's field of view. In the License Plate menu, you can configure various parameters related to this detection function.

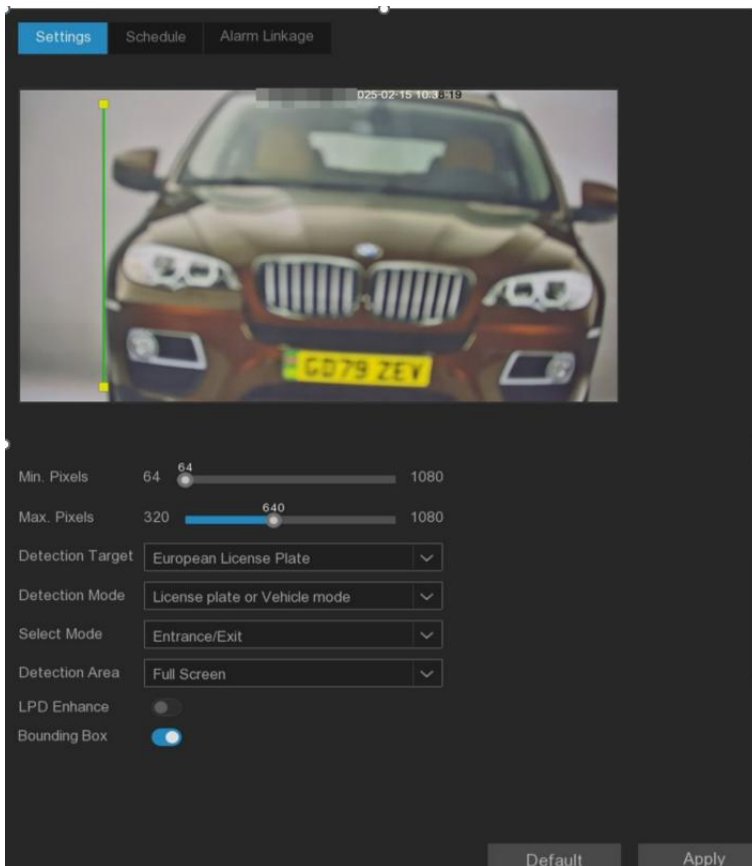

Min.pixels: Minimum recognition pixel box, the license plate must be bigger than the set minimum pixel to be recognized.

Max.pixels: Maximum recognition pixel box, the license plate should be smaller than the set maximum pixel to be recognized.

Detection Target: Select the type of license plate, such as American license plates, European license plates, etc.

Detection Mode: This setting determines the method used to detect targets within the camera's field of view. There are two modes available, please choose according to your specific needs.

- **European license plate:** European license plate.
- **American license plate:** American license plate.

Select Mode: Application mode, according to the actual installation position to select the corresponding application mode can improve the effect of license plate capture, there are the following three modes.

Entrance / Exit: Gate entrance and exit scene.

City Street: City street scene.

Alarm Input: Alarm input mode (the camera is required to support I/O alarm input).

Note: Select **Entrance/Exit** and **City Street** need to set detect line position in the video screen. When the license plate touches the detection line will capture. Select Alarm Input mode, don't need to set up detection line, when the alarm input is triggered, the license plate in the detection area will always be captured until the alarm input signal is over.

Detection Area: Used to set the area for triggering target detection,, it allows you to customize the area, enabling the system to focus on the specific areas you are concerned about:

Full Screen: Detect the full screen area

User-defined: Customize the detection area.

Bounding Box: When enabled, a green bounding box will be displayed on the images, outlining and identifying detected targets. This aids in quickly locating and recognizing captured objects of interest.

LPD Enhance: Enable/disable license plate enhancement. License Plate Enhance is a feature that helps improve the clarity and readability of license plates in the captured images or video feed. Its main purpose is to enhance the license plate region, making it easier for the license plate detection algorithms to accurately recognize and identify the license plate characters.

Note: Enabled the LPD Enhance, the image control automatically switch to day and night mode , IR-CUT Mode will switch to Image mode and hide Exposure Compensation, Shutter and Exposure Time.

5.4.1.4 Intrusion

Intrusion detection can detect whether there is an object invading the set restricted area in the video. This feature is useful for monitoring restricted areas and detecting unauthorized entry or trespassing activities. It helps enhance security and surveillance in locations such as warehouses, construction sites, or other restricted premises. Whether this feature is supported depends on the camera model being used.

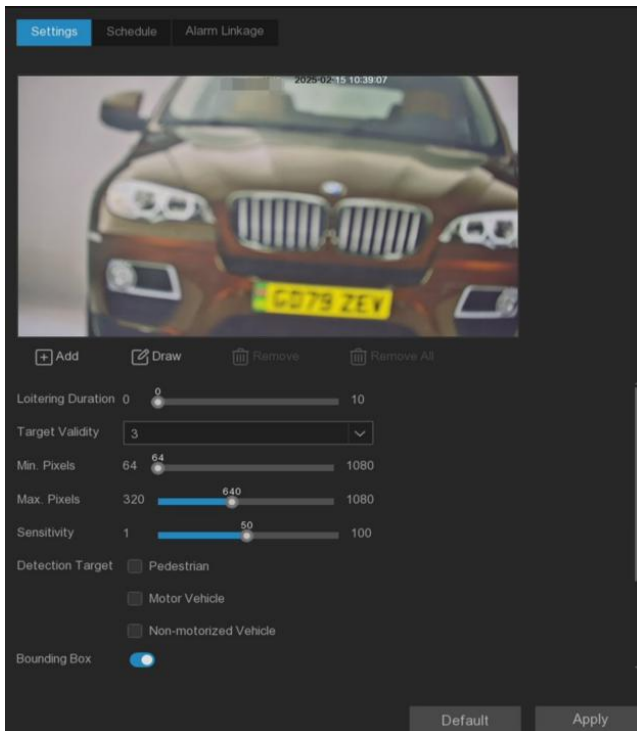

Loitering Duration: It indicates the time duration (in seconds) an object must remain in the alert area before triggering an alarm. For example, if set to 5, the alarm will trigger immediately after the target has invaded the area for 5 seconds. The maximum duration can be set up to 10 seconds.

Target Validity: Target confidence, indicating the similarity between the target and the set detection type, and the alarm will be triggered only after reaching or exceeding the set similarity. The higher the setting level, the higher the similarity requirement, the more obvious the required target features, and the higher the alarm accuracy. Level can be set to 1 to 4, 1 as the highest confidence. The similarity requirements of the detection target corresponding to each level are: 1~80%, 2~60%, 3~40%, and 4~20%.

Min. Pixels: Set the minimum recognition pixel, the target should be bigger than the set pixel to be identified.

Max.Pixels: Set the maximum recognition pixel, and the target should be smaller than the set pixel to be identified.

Sensitivity: Sensitivity setting to trigger area intrusion detection, the higher the sensitivity setting, the easier it is to trigger the alarm.

Detection Target: Set the target type that needs to be detected.

- **Pedestrian:** Only detect intruding pedestrians
- **Motor Vehicle:** Only detect intruding motorized vehicles
- **Non-Motorized:** Only detect intruding non-motorized vehicles

No Target Type Selected: All moving targets will be detected.

Rule Number: Select the rule number. In the upper preview screen, click the left mouse button to draw the detection area connected by the head and tail end points. After drawing, click Save to complete the area drawing. When the alert area needs to be cleared, click "Remove to delete the selected painted area. Click " **Remove All** " to delete all painted areas.

Rule Switch: When enabled, the set detection area takes effect.

Bounding Box: When enabled, the target detection frame displays in the real-time screen.

5.4.1.5 Enter Region

The Enter Region Detection function can detect whether target enters the set alert area, and link the alarm according to the judgment result.

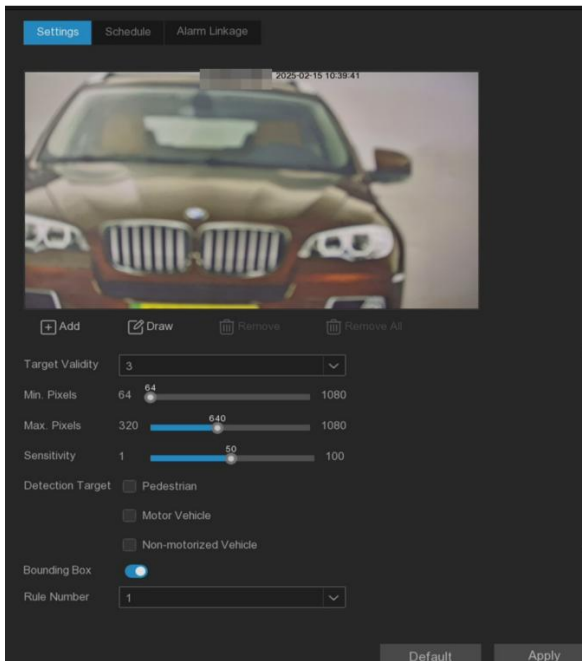

Target Validity: Target confidence, indicating the similarity between the target and the set detection type, and the alarm will be triggered only after reaching or exceeding the set similarity. The higher the setting level, the higher the similarity requirement, the more obvious the required target features, and the higher the alarm accuracy. Level can be set to 1 to 4, 1 as the highest confidence. The similarity requirements of the detection target corresponding to each level are: 1~80%, 2~60%, 3~40%, and 4~20%.

Min. Pixels: Set the minimum recognition pixel, the target should be greater than the set pixel to be identified.

Max.Pixels: Set the maximum recognition pixel, and the target should be smaller than the set pixel to be identified.

Sensitivity: trigger the sensitivity setting of area intrusion detection. The greater the sensitivity setting, the easier it is to trigger the alarm.

Detection Target: Set the detection target, can choose "human type", "motor vehicle", "non-motor vehicle". "Human type" means only invading pedestrians, "motor vehicle" means only invading

motor vehicles, "non-motor vehicle" means only invading non-motor vehicles, and "no type" means detecting all moving targets.

Rule Number: Select the rule number, click the left mouse button in the top preview screen to draw the detection area connected by the end and tail ends. After the drawing, click Save to complete the area drawing. When the alert area needs to be cleared, click "Remove" to delete the selected painted area. "Remove All" to delete all painted areas.

Rule Switch: When enabled, the set detection area takes effect.

Bounding Box: When turned on, the target detection frame is displayed in the real-time screen.

5.4.1.6 Exit Region

The Exit Region function can detect whether there is an object leaving the set alert area, and link the alarm according to the judgment result.

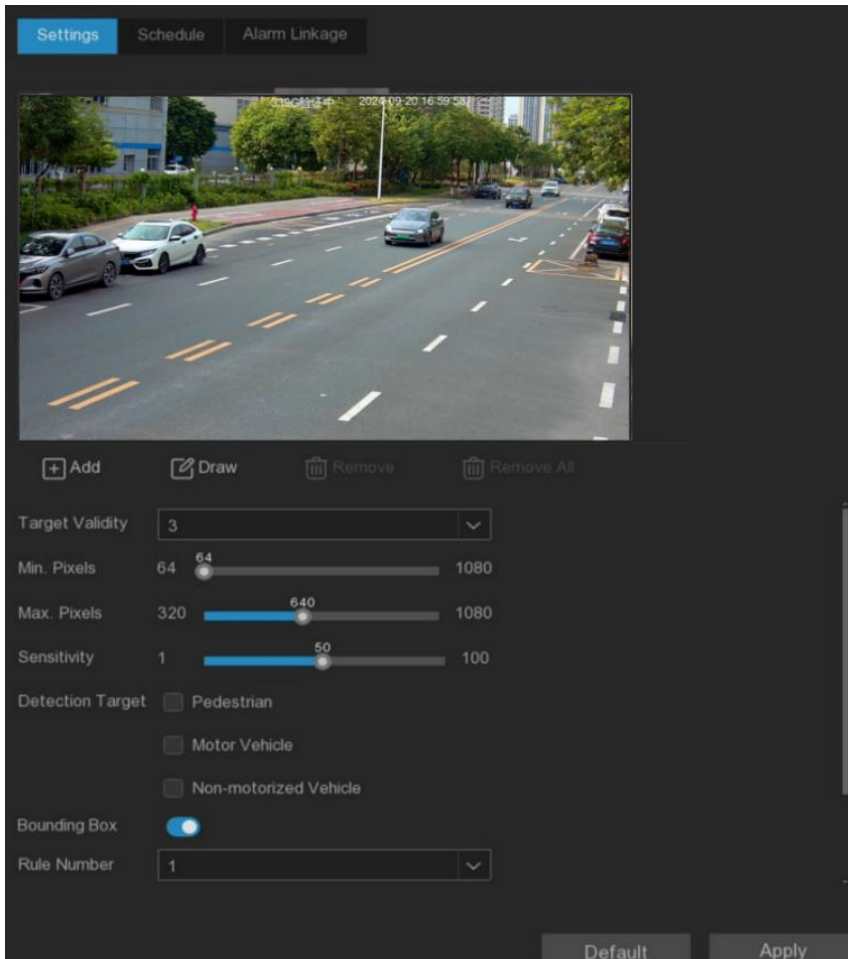

Target Validity: Target confidence, indicating the similarity between the target and the set detection type, and the alarm will be triggered only after reaching or exceeding the set similarity. The higher the setting level, the higher the similarity requirement, the more obvious the required target features, and the higher the alarm accuracy. Level can be set to 1 to 4, 1 as the highest confidence. The similarity requirements of the detection target corresponding to each level are: 1~80%, 2~60%, 3~40%, and 4~20%.

Min. Pixels: Set the minimum recognition pixel, the target should be greater than the set pixel to be identified.

Max. Pixels: Set the maximum recognition pixel, and the target should be smaller than the set pixel to be identified.

Sensitivity: trigger the sensitivity setting of area intrusion detection. The greater the sensitivity setting, the easier it is to trigger the alarm.

Detection Target: Set the detection target, can choose "human type", "motor vehicle", "non-motor vehicle". "Human type" means only invading pedestrians, "motor vehicle" means only invading motor vehicles, "non-motor vehicle" means only invading non-motor vehicles, and "no type" means detecting all moving targets.

Rule Number: Select the rule number, click the left mouse button in the top preview screen to draw the detection area connected by the end and tail ends. After the drawing, click Save to complete the area drawing. When the alert area needs to be cleared, click "Remove" to delete the selected painted area. "Remove All" to delete all painted areas.

Rule Switch: When enabled, the set detection area takes effect.

Bounding Box: When turned on, the target detection frame is displayed in the real-time screen.

5.4.1.7 Line Crossing

The Line Crossing function can detect people, vehicles or other objects that have crossed a predetermined virtual line and take certain measures when an alarm is triggered.

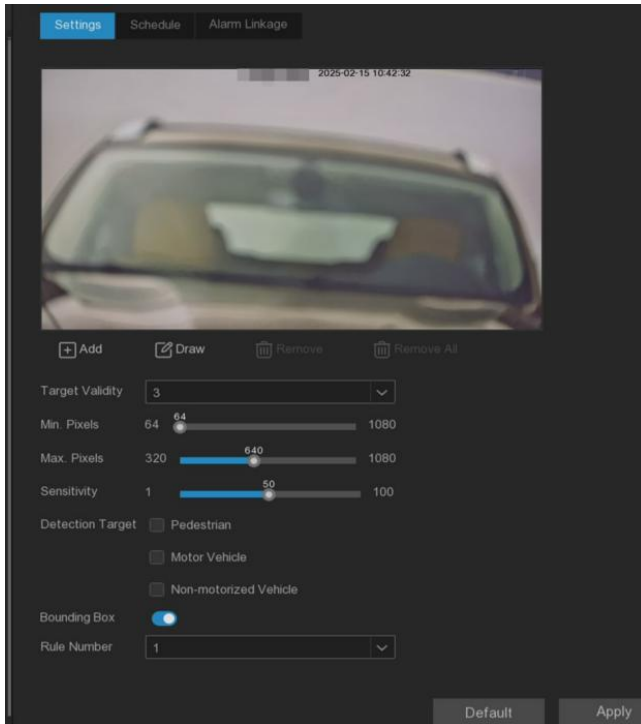

Target Validity: Target confidence, indicating the similarity between the target and the set detection type, and the alarm will be triggered only after reaching or exceeding the set similarity. The higher the setting level, the higher the similarity requirement, the more obvious the required target features, and the higher the alarm accuracy. Level can be set to 1 to 4,1 as the highest confidence. The similarity requirements of the detection target corresponding to each level are: 1~80%, 2~60%, 3~40%, and 4~20%.

Min. Pixels: Set the minimum recognition pixel, the target should be greater than the set pixel to be identified.

Max.Pixels: Set the maximum recognition pixel, and the target should be smaller than the set pixel to be identified.

Sensitivity: trigger the sensitivity setting of Line Crossing. The greater the sensitivity setting, the easier it is to trigger the alarm.

Detection Target: Set the detection target, can choose "human type", "motor vehicle", "non-motor vehicle"."Human type" means only invading pedestrians, "motor vehicle" means only invading motor vehicles, "non-motor vehicle" means only invading non-motor vehicles, and "no type" means detecting all moving targets.

Rule Number: Select the rule number, click the left mouse button to draw the appropriate detection line in the top preview screen. After the drawing, click Save to complete the detection line drawing. When the detection line needs to be cleared, click "Remove to delete the selected detection line. click" Remove All " to delete all detection lines.

Rule Switch: When enabled, the set detection line takes effect.

Rule Type: Select the rule type

A (B: detect only the movements from side A to side B.

B (A: detect only the movements from side B to side A.

A ((B: will detect movements from side B to side A or from side A to side B.

Bounding Box: When turned on, the target detection frame is displayed in the real-time screen.

Note:

1. The detection line should not be too close to the edge of the camera image, so as to trigger an alarm when the target passes through the camera.
2. The detection line should not be set too short to avoid failing to trigger an alarm when the target crosses the detection line.

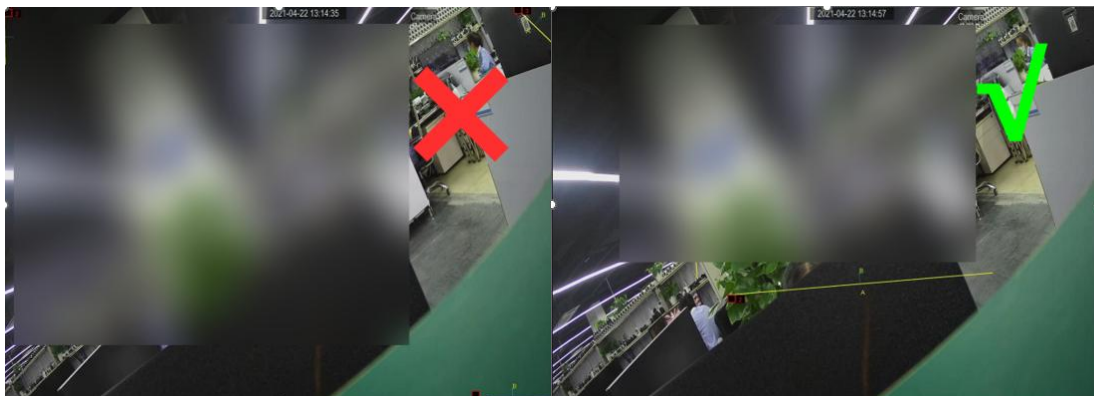

5.4.1.8 Object Detection

The Object detection can detect the objects left or lost in the predetermined area, such as luggage, wallet, dangerous goods, etc., and take a series of measures when triggering the alarm.

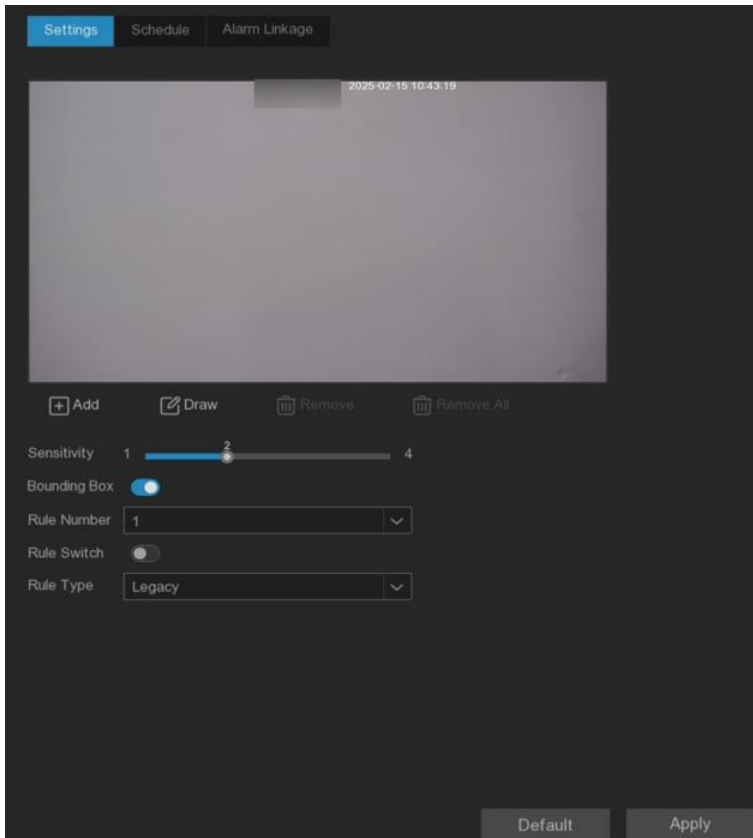

Sensitivity: Sensitivity, parameter range of 1 to 4, default value of 2. The higher the sensitivity, the more likely the left or lost objects in the detection area will be detected, and the more false detection will be detected, and the corresponding missed detection will be reduced. It is recommended to keep the default value.

Rule Number: Select the rule number, click the left mouse button in the top preview screen to draw the detection area connected by the end and tail ends. After the drawing, click Save to

complete the area drawing. When the alert area needs to be cleared, click "Remove" to delete the selected painted area. "Remove All" to delete all painted areas.

Rule Switch: When enabled, the set detection area takes effect.

Bounding Box: When turned on, the target detection frame is displayed in the real-time screen.

Rule Type: Select the rule type.

Legacy Legacy: Detect only the objects left in the detection area.

Lost Loss: only detect lost objects in the detection area.

Legacy & Loss legacy and lost: will detect left and lost objects in the detection area.

Mouse-click 4 points in the camera image to draw a virtual area. The area shall be a convex polygon. The concave polygon will not be saved.

Note:

1. The detection area should be greater than or equal to the size of the detected object, such as the detection of blue bottles.
2. The detected objects cannot be obscured.



5.4.1.9 Cross Counting

The Cross Counting function counts the statistics of people, motor vehicles, non-motor vehicles or moving objects that cross the detection line.

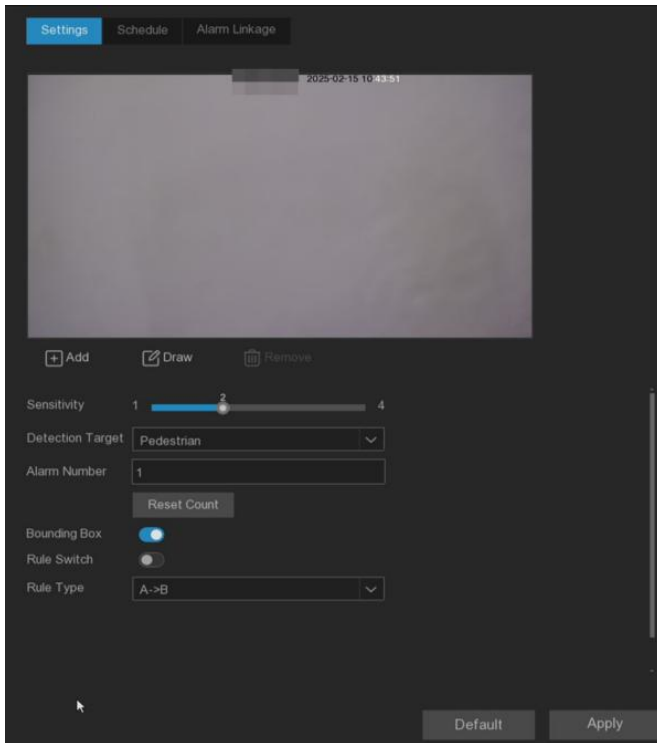

Sensitive: The sensitivity level is 1 to 4, and the default value is 2. Higher sensitivity will trigger detection more easily.

Detection Target: Set line crossing statistics target type

Motion: Count any moving objects over the line.

Pedestrian: Only count the pedestrians crossing the line.

Motor Vehicle: Only count the motor vehicles that cross the line.

Non-motorized Vehicle: count only the non-motor vehicles passing the line.

Alarm Number: Set the number of alarms. Alarm Num= (number of cross in) - (number of cross out), reaching the set value will alarm.

Reset Count: Clear the count and recount.

Rule Switch: When enabled, the set detection line takes effect.

Rule Type: Rule type

A-> B: People or objects from side A to side B will be counted.

B-> A: People or objects from side B to side A will be counted.

Bounding Box: When turned on, the target detection frame is displayed in the real-time screen.

Click the "Add d (Add)" button to add a detection line or click the "Draw (Draw)" button to manually draw a detection line. If you want to modify the position or range of the detection line, click the red box in the line and the color of the line turns red. Long press the left mouse button to move the detection line, or drag the endpoint to modify the length or position of the line.

If you want to delete the detection line, click the red box in the line, and then click the Remove (Remove) button.

Note:

1. The detection line should not be too close to the edge of the image to avoid not triggering the alarm when the target crosses the detection line.
2. The test line should be located in the area where the detected object can reach.
3. The detection line should not be set too short so as not to trigger the alarm when the target crosses the detection line.



5.4.1.10 Heat map

Show the diagram of the page area of the visitor and the geographical area of the visitor in a special highlight form, and the heat map also shows which areas of the picture attract most of the visitors.

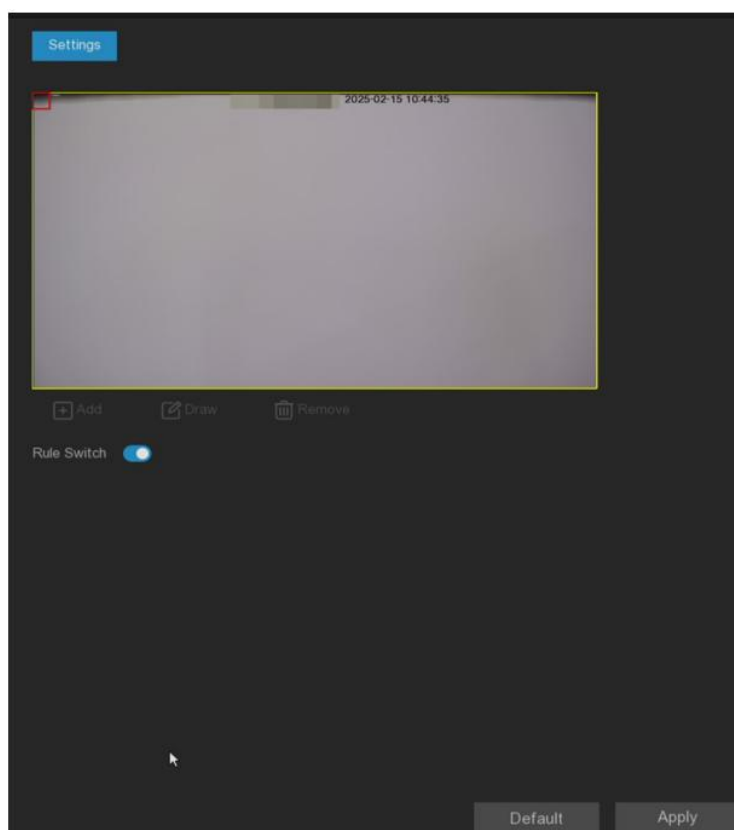

Rule Switch: Enable or disable the detection area.

Add: Add a default detection region.

Draw: manually draw the detection area.

Remove: Select the detection area box and click Remove to remove the detection box.

5.4.1.11 Crowd Density

Crowd Density function is used to detect population aggregation to maintain a controllable order in a specific area.

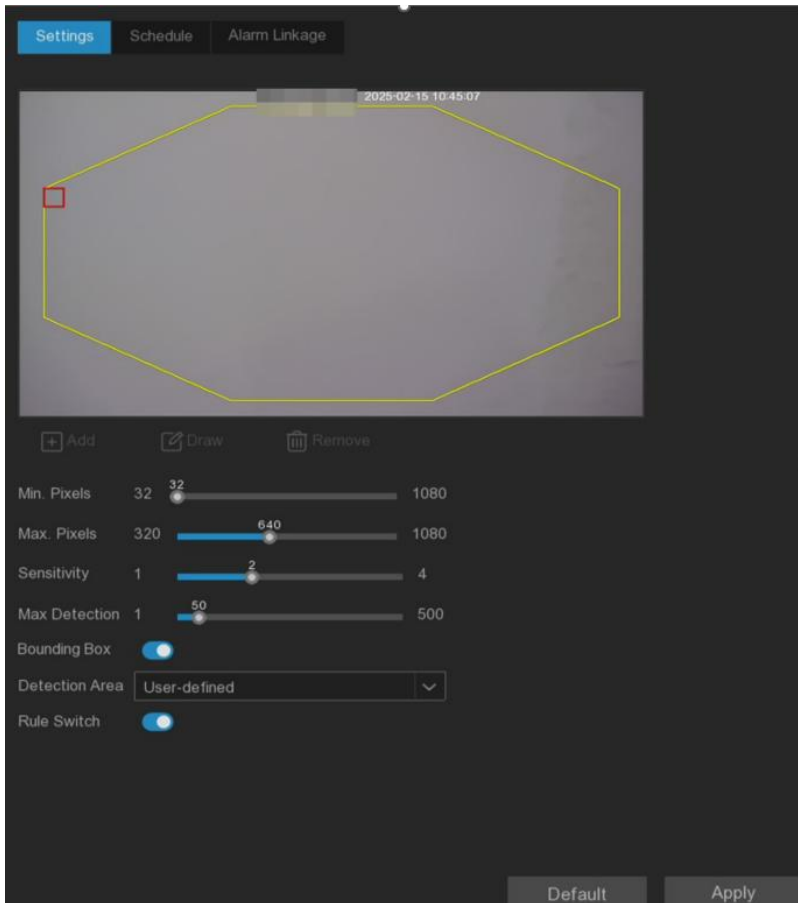

Min.pixels: Set the minimum recognition pixel box, the person should be greater than the set pixel to be identified.

Max.pixels: Set the maximum recognition pixel box, the person should be less than the set pixel to be identified.

Sensitivity: Sensitivity levels are from 1 to 4. Higher sensitivity would trigger detection more easily.

Max Detection: When the number of people in the detection area exceeds the maximum number, the population density alarm will be triggered.

Bounding Box: When turned on, the target detection frame is displayed in the real-time screen.

Detection Area: Test areas for population density are set, as follows:

Full Screen: Full-screen detection.

User-defined: Custom test area.

Rule Switch: Enable or disable the detection area.

5.4.1.12 Queue Length

Queue Length detection is used to detect the status of the cohort, including its length and stall time.

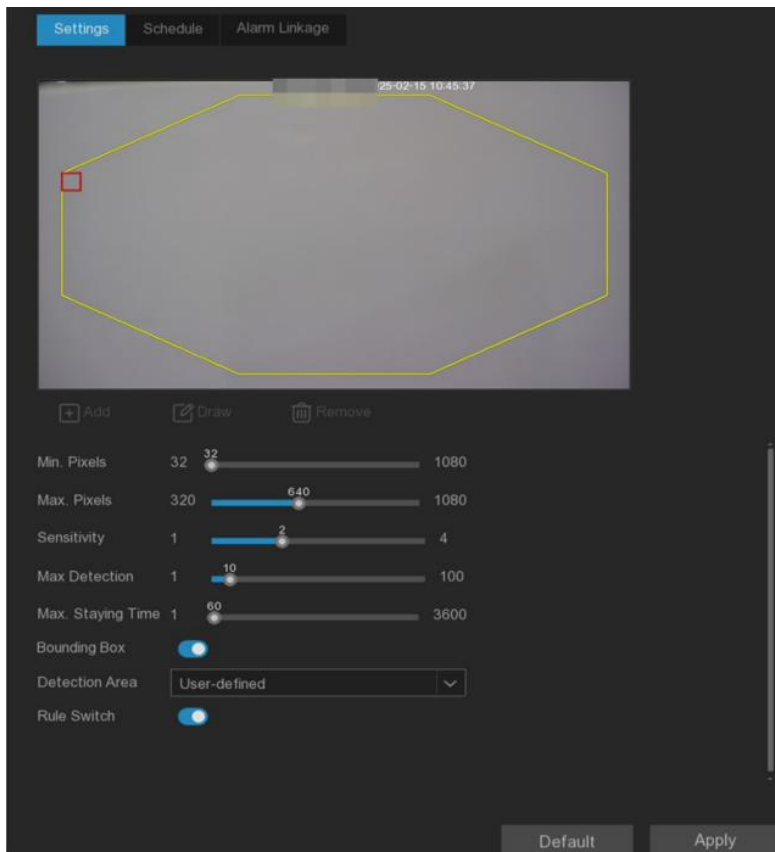

Min.pixels: Set the minimum recognition pixel box, the person should be greater than the set pixel to be identified.

Max.pixels: Set the maximum recognition pixel box, the person should be less than the set pixel to be identified.

Sensitivity: Sensitivity levels are from 1 to 4. Higher sensitivity would trigger detection more easily.

Max Detection: When the number of people in the detection area exceeds the maximum number of people, the queue length alarm will be triggered.

Max.Satying Time: When the stop time of the queue exceeds the set processing time, the queue length alarm will be triggered.

Bounding Box: When turned on, the target detection frame is displayed in the real-time screen.

Detection Area: Set the detection area of the queue length in the following two types:

Full Screen: Full-screen detection.

User-defined: Custom test area.

Rule Switch: Enable or disable the detection area.

5.4.1.13 Rare Sound

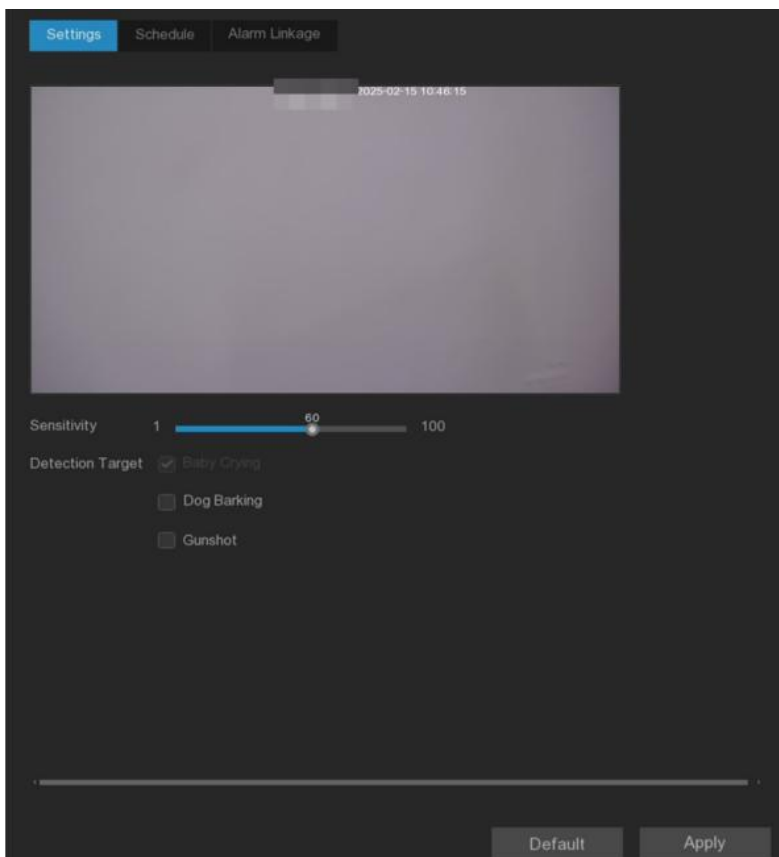

Sensitivity: Sensitivity setting, higher sensitivity will be easier to trigger detection.

Detection Target: Detection type

Baby Crying: Baby crying can be detected after checking.

Dog Barking: The barking sound can be detected after checking.

Gunshot: Gunfire can be detected after checking it.

5.4.1.14 Motion Detection

Users can configure the relevant parameters for the motion detection on this page. A motion detection alarm is triggered when the motion target in the screen.

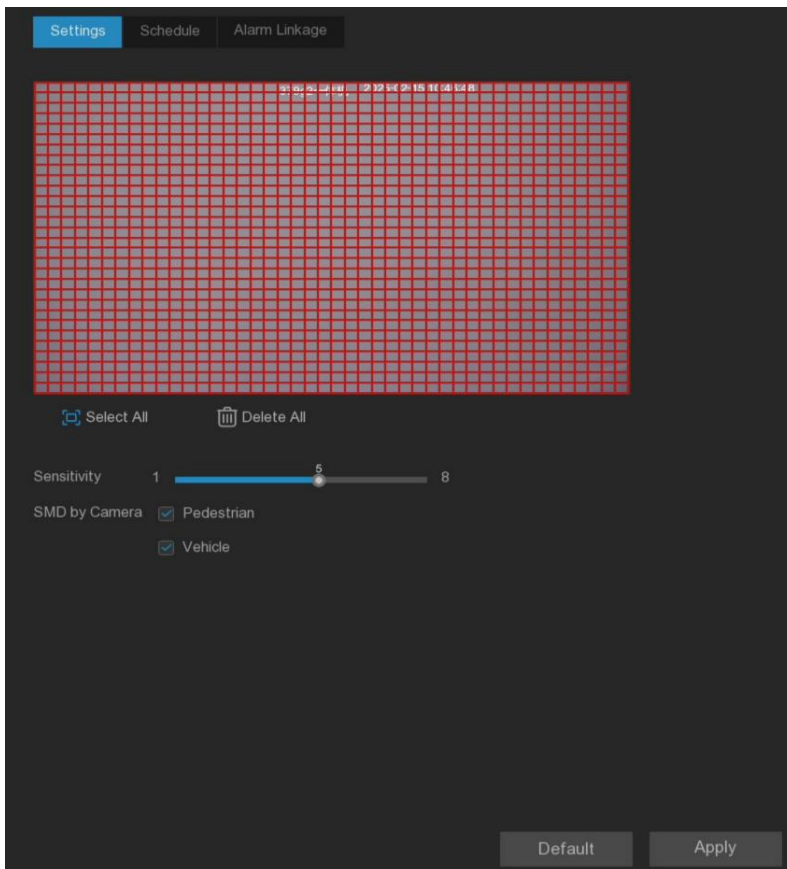

Sensitivity: Set the sensitivity level, the higher the sensitivity, the farther the distance of detection.

SMD by Recorder: Suitable for cameras that do not support intelligent motion detection function, with Pedestrian, Vehicle, and two detection types are optional. Without checked, the movement of any object can trigger a motion detection alarm.

SMD by Camera: Suitable for network cameras to support intelligent motion detection function, Pedestrian, Vehicle, two detection types are optional. Without checked, the movement of any object can trigger a motion detection alarm.

5.4.1.15 Video Tampering

The Video Tampering function can be used to detect whether the monitoring picture is blocked and to take a series of measures when the alarm is triggered.

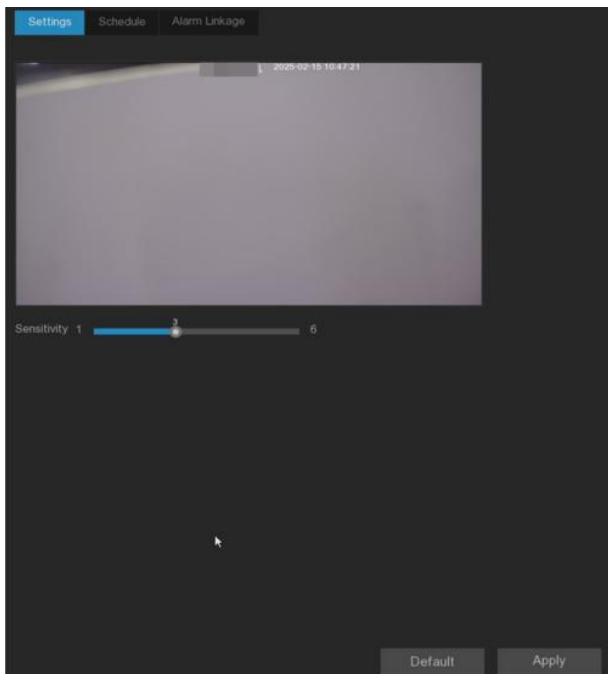

Sensitivity: The sensitivity level is 1 to 6, and the default value is 4. The higher the sensitivity, the easier it is to trigger the alarm.

5.4.1.16 Schedule sheet

Configure the time period for each event, and the schedule details refer to 5.2.1.1 Video schedule.

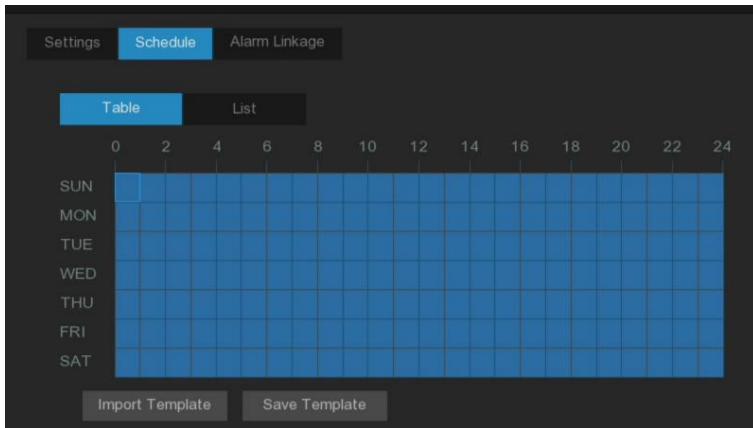

Note:

1. Setting schedule is not supported for heat map.
2. The camera channel move detection is not supported by the Onvif protocol.

5.4.1.17 Alarm linkage

After configure the alarm trigger of each event, execute the corresponding alarm linkage.

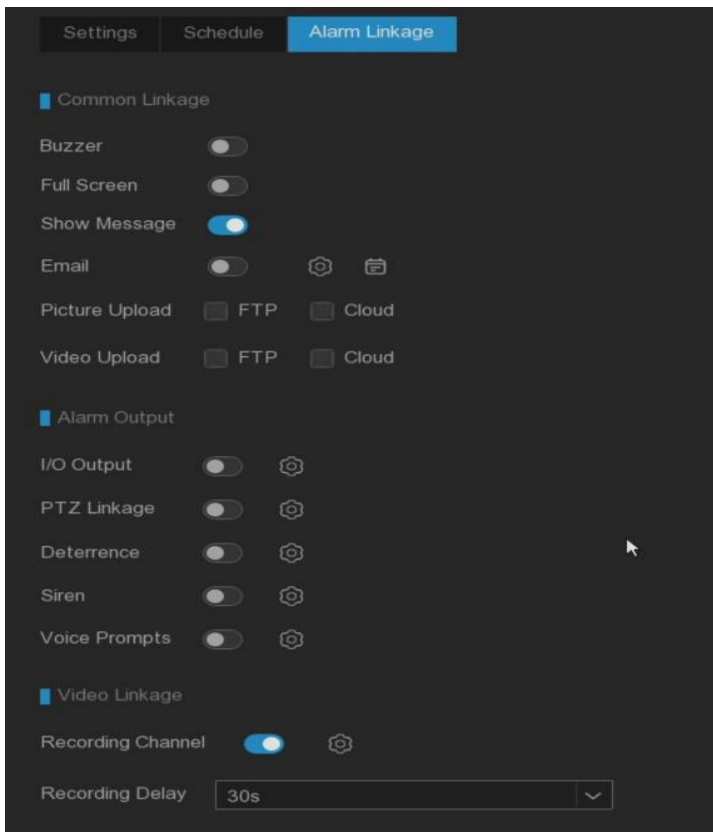

Buzzer: Set whether the device will beep after the event alarm occurs, and the beep lasts for 10 seconds.

Full Screen: Set whether the full-screen preview of the channel after the event alarm occurs.

Show Message: Set whether the icon is displayed on the real-time preview channel after the event alarm occurs.

Email: Set whether to send an email to the mailbox after an event alarm occurs. Click the setting button and schedule button on the right to configure the message parameters. Please refer to **5.5.4.1 mail configuration for detailed settings.**

Picture Upload: Set whether to upload the alarm grab map to the configured FTP server and cloud storage server after the event alarm occurs.

Video Upload: Set whether to upload the alarm video to the configured FTP server and cloud storage server after the event alarm occurs.

I/O Output: Set whether the alarm output after the event alarm occurs. Click the setting button on the right to configure the alarm output source.

PTZ Linkage: Set whether the PTZ is linked after the event alarm occurs. Click the right setting button to configure the PTZ linkage.(High-Speed Dome requiring access support can be linked)

Preset: Linkage the preset point, set the residence time of the preset point and the preset point. When the event alarm occurs, the linkage PTZ will rotate to the set preset point.

Tour: Set the track cruise and set the track. When the event alarm occurs, it will cruise according to the set track cruise linkage PTZ.

Pattern Scan: Set the pattern scan. When the event alarm occurs, it will cruise according to the set pattern cruise linkage PTZ.

Deterrence: Set whether the warm light and red and blue light of the camera are linked after the event alarm occurs. Click the setting button on the right side to configure the Deterrence parameters of the camera. Please refer to 5.3.5.1 warm light and red and blue light for detailed setting.

Siren: Set whether to link the alarm sound of the camera after the event alarm occurs. Click the setting button on the right side to configure the Siren parameters of the camera. Please refer to 5.3.5.2 alarm sound for detailed setting.

Voice Prompts: Set whether to broadcast after the event alarm occurs. Please, refer to 5.3.4 Voice Prompts.

Recording Channel: Set the channel required to record after the event alarm occurs.

Recording Delay: Set the duration of continuous recording after the event alarm occurs.

5.4.2 List Management

5.4.2.1 Face Recognition Management

This menu can set the database and alarm linkage.

		Group Name	Delete	Edit	Enable	Alarm	Policy	Similarity	Alarm Linkage	Alarm Schedule	Alarm Channel
1	■	Allowed	🗑️	✏️	🟢	🟢	Allowed	≈ 70 %	⚙️	⚙️	⚙️
2	■	Forbidden	🗑️	✏️	🟢	🟢	Disallowed	≈ 70 %	⚙️	⚙️	⚙️
3	□	Stranger	🗑️	✏️	🟢	🟢	Stranger	< 70 %	⚙️	⚙️	⚙️
4	■	Group 1	🗑️	✏️	🟢	🟢	Allowed	≈ 70 %	⚙️	⚙️	⚙️
5	■	Group 2	🗑️	✏️	🟢	🟢	Allowed	≈ 70 %	⚙️	⚙️	⚙️
6	■	Group 3	🗑️	✏️	🟢	🟢	Allowed	≈ 70 %	⚙️	⚙️	⚙️

Import Database: The exported face data can be imported into the device.

Backup Database: You can export the face database to the U disk.

Update face attributes: Update face features, in switching the face feature model or imported face images or face library, from the camera recognition to detect the face after the face library face image face features and the current check face features model is inconsistent, will pop up update face features, click update face features will be shown in the following figure.

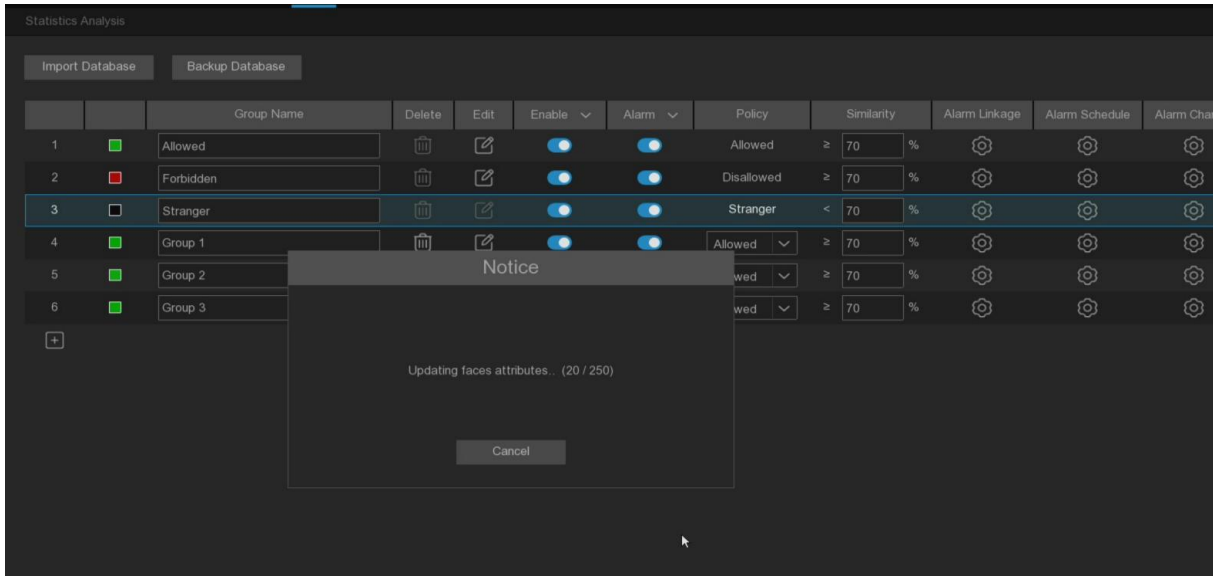

Click Cancel will prompt to continue or stop the update, the remaining not updated next click to update

Click /: You can add new face groups or delete existing face groups.(The default first three face groups cannot be deleted)

Enable: The face group can be enabled or closed.

Edit: Click Edit to enter the Edit face group interface.

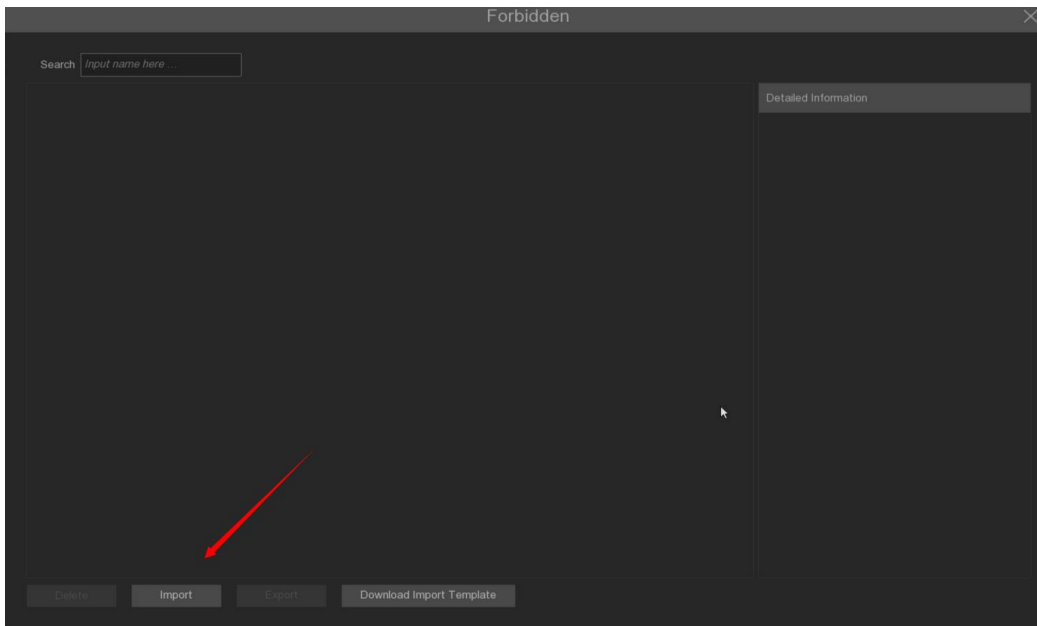

Import: Click and select Local Storage Device to add the local face interface.

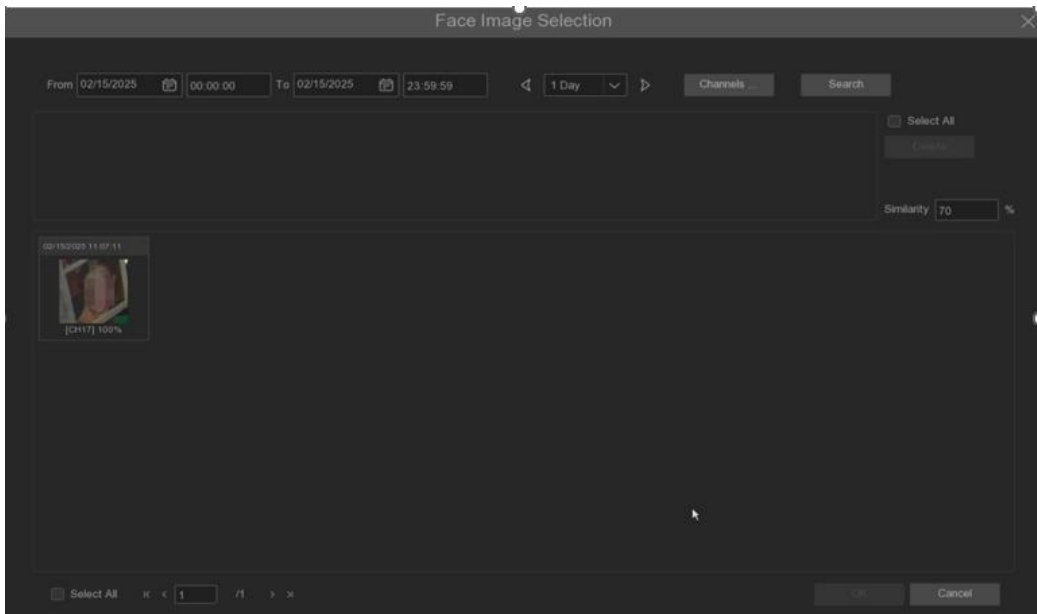

Select the date, duration and channel after point Search to search for faces saved by all devices during that time. If the face is set similarity and then click Search, you will search out the face matching the selected face similarity. Select the face in the search area and click Delete to delete the face in this search area. Select the human face and click OK to enter the input human face information interface

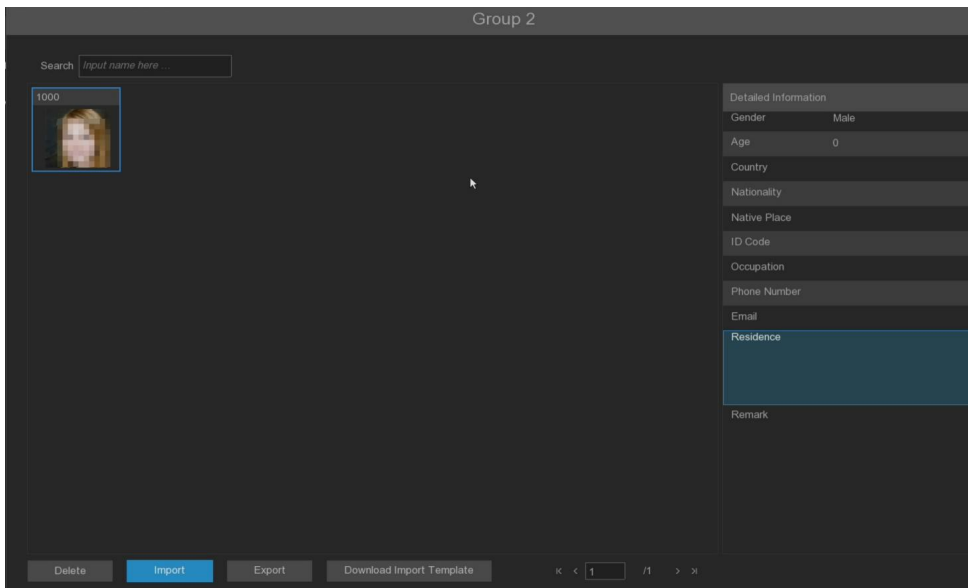

On the right side, the face information can edit the information. After editing, click Import to complete the import and click Exit to exit the interface.

Click [External Storage Device](#) to enter the external memory, select the face picture you want to import, the same step as importing the local face.

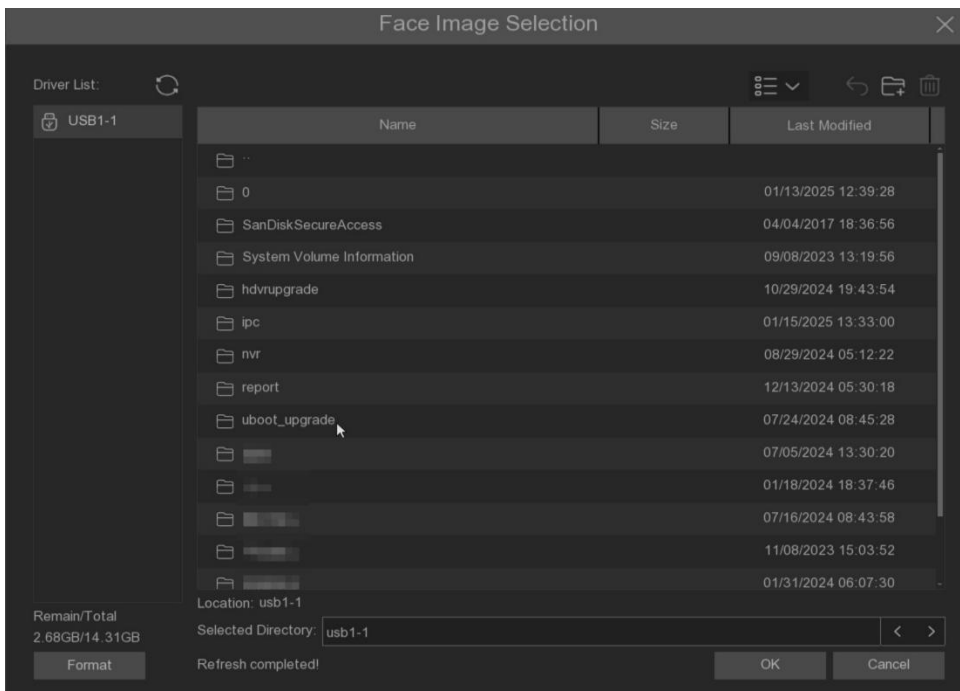

Export: Export the face image to the external memory, if not click to the face group image to click Export to export all the face group face image. If click to the face group face image to click Export to export the selected face image.

Download import Template: Download and import the template, can export a template to external memory, this template can contain a table and instructions, can fill in the face picture information in this form, import this form can modify the information of multiple face pictures, convenient to modify the face picture information.

Right click to select the face picture, select Edit to enter the face picture editing interface, click

Additional Face Images to import the face picture in different circumstances of the face.

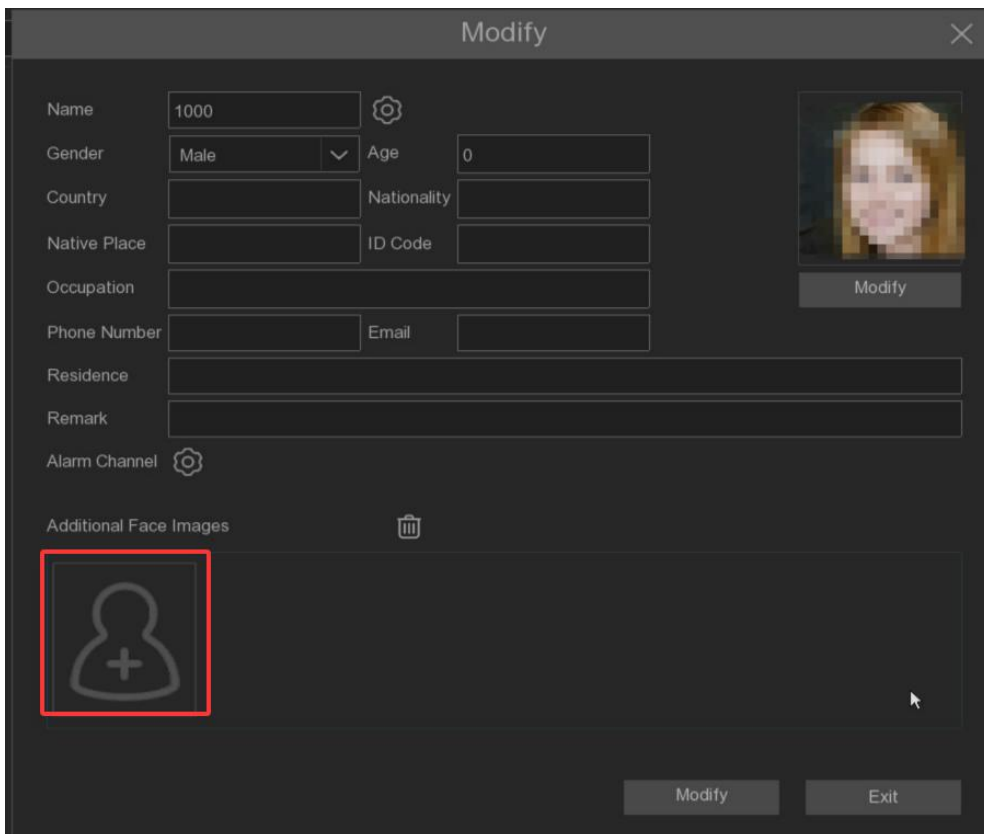







































Alarm: Open or close the face comparison alarm of the face group.

Policy: Set up the face group alarm countermeasures

Similarity: Similarity setting

Alarm Linkage: Click  to enter the setting interface.

Alarm [Allowed]							
Channel	Buzzer	Alarm Out	Email	FTP Picture Upload	Picture to Cloud	Voice Prompts	
CH1 (529+4210poe)	<input type="checkbox"/>	<input checked="" type="checkbox"/>		<input type="checkbox"/>	<input type="checkbox"/>		
CH2 (30kq824)	<input type="checkbox"/>	<input checked="" type="checkbox"/>		<input type="checkbox"/>	<input type="checkbox"/>		
CH3 (Camera)	<input type="checkbox"/>	<input checked="" type="checkbox"/>		<input type="checkbox"/>	<input type="checkbox"/>		
CH4 (Camera823)	<input type="checkbox"/>	<input checked="" type="checkbox"/>		<input type="checkbox"/>	<input type="checkbox"/>		
CH5 (1111122222333334444455555666667)	<input type="checkbox"/>	<input checked="" type="checkbox"/>		<input type="checkbox"/>	<input type="checkbox"/>		
CH6 (338g)	<input type="checkbox"/>	<input checked="" type="checkbox"/>		<input type="checkbox"/>	<input type="checkbox"/>		
CH7 ()	<input type="checkbox"/>	<input checked="" type="checkbox"/>		<input type="checkbox"/>	<input type="checkbox"/>		
CH8 (529+4210one)	<input type="checkbox"/>	<input checked="" type="checkbox"/>		<input type="checkbox"/>	<input type="checkbox"/>		
CH9 (lll)	<input type="checkbox"/>	<input checked="" type="checkbox"/>		<input type="checkbox"/>	<input type="checkbox"/>		
CH10 (live)	<input type="checkbox"/>	<input checked="" type="checkbox"/>		<input type="checkbox"/>	<input type="checkbox"/>		
CH11 (529-850)	<input type="checkbox"/>	<input checked="" type="checkbox"/>		<input type="checkbox"/>	<input type="checkbox"/>		
CH12 (16>z<338g)	<input type="checkbox"/>	<input checked="" type="checkbox"/>		<input type="checkbox"/>	<input type="checkbox"/>		
CH13 (Camera)	<input type="checkbox"/>	<input checked="" type="checkbox"/>		<input type="checkbox"/>	<input type="checkbox"/>		
CH14 (3)	<input type="checkbox"/>	<input checked="" type="checkbox"/>		<input type="checkbox"/>	<input type="checkbox"/>		
CH15 (5)	<input type="checkbox"/>	<input checked="" type="checkbox"/>		<input type="checkbox"/>	<input type="checkbox"/>		
CH16 (1200)	<input type="checkbox"/>	<input checked="" type="checkbox"/>		<input type="checkbox"/>	<input type="checkbox"/>		
CH17 (529+11)	<input type="checkbox"/>	<input checked="" type="checkbox"/>		<input type="checkbox"/>	<input type="checkbox"/>		
CH18 (338g)	<input type="checkbox"/>	<input checked="" type="checkbox"/>		<input type="checkbox"/>	<input type="checkbox"/>		
CH19 (Nancy)	<input type="checkbox"/>	<input checked="" type="checkbox"/>		<input type="checkbox"/>	<input type="checkbox"/>		

Buzzer: Set whether the device sounds beep after the alarm, and the beep lasts for 10 seconds.

Alarm Out: Set whether the alarm output is linked after the face comparison alarm occurs. Click the setting button to configure the alarm output source.

Email: Set whether to send an email to the mailbox after the face comparison alarm occurs.

FTP Picture Upload: Set whether to upload the alarm grab to the configured FTP server after the alarm occurs.

Picture to Cloud: Set whether to upload the alarm grab to the configured cloud storage server after the alarm occurs.

Voice Prompts: Set whether to broadcast after the face comparison occurs. Please refer to 5.3.4 Voice Prompts.

Alarm Schedule: Set the time period for each camera channel to enable face alignment. Please refer to 5.2.1.1 Video schedule.

Alarm Channel: Set the channel for the face group to enable the face comparison and alarm.

5.4.2.2 License Plate Management

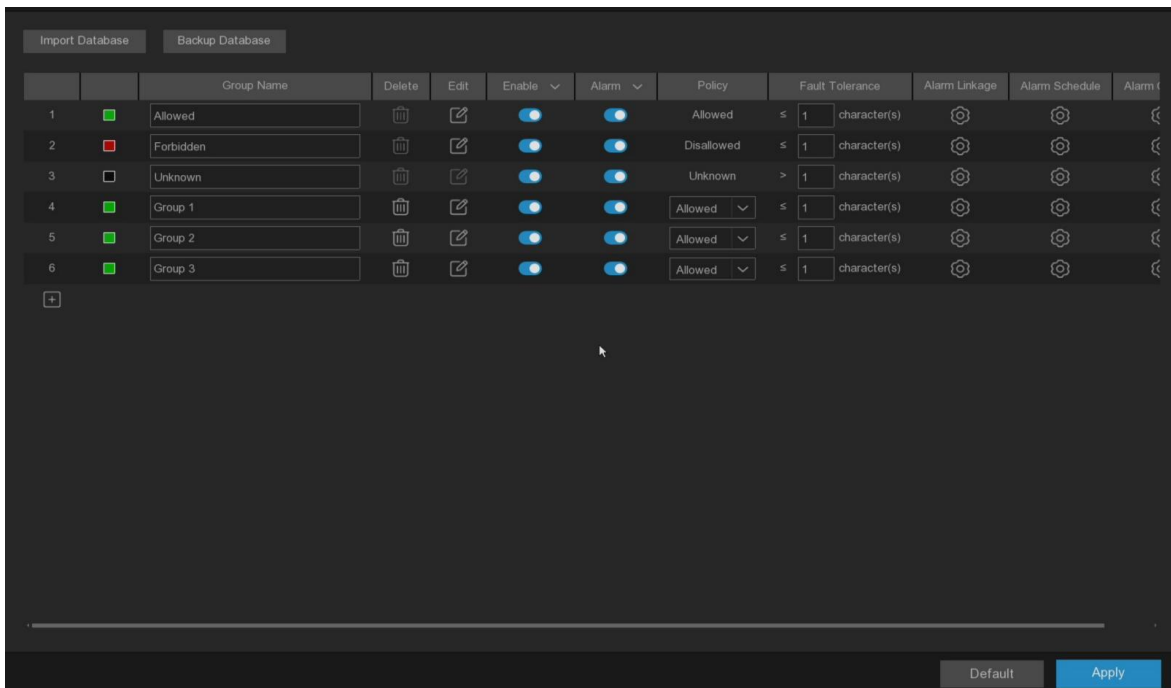

This menu can set the database of the license plate identification comparison and the alarm linkage.



Import Database: You can import the exported group data into the device.

Backup Database: You can export all the groups to the U disk.

Group Name: The name of the database ■ group, expressed ■ as a white list, ■ expressed as a blacklist, indicating the unfamiliar license plate list, at the same time, you can add up to 61 custom groups, a total of 64 groups, one group can accommodate up to 5,000 license plate information, the whole database can accommodate 10,000 license plate information.

Click  / : You can add a new plate group or delete an existing plate group.(The first three plates cannot be deleted)

Enable: The license plate group can be enabled or closed.

Edit: Click Edit to enter the edit license plate group interface.

Allowed ✕

Search Total: 5000

<input type="checkbox"/>	Edit	License Plate	Color	Brand	Model	Owner	Gender	ID Code	Phone Number	Occupation	Residence	Remark
<input type="checkbox"/>		W32 PRA	Blue	HJHJH	Volkswagen	GSY5DGDGXGH	Male	131	2212242	22222	46492	KUKTT
<input type="checkbox"/>		W33 PRA	Blue	HJHJH	Volkswagen	GSY5DGDGXGH	Male	132	2212243	22222	46493	TRYRTHFX
<input type="checkbox"/>		W34 PRA	Blue	HJHJH	Volkswagen	GSY5DGDGXGH	Male	133	2212244	22222	46494	WGAA
<input type="checkbox"/>		W35 PRA	Blue	HJHJH	Volkswagen	GSY5DGDGXGH	Male	134	2212245	22222	46495	FFQFQFQ
<input type="checkbox"/>		W36 PRA	Blue	HJHJH	Volkswagen	GSY5DGDGXGH	Male	135	2212246	22222	46496	FQFQWQ
<input type="checkbox"/>		W37 PRA	Blue	HJHJH	Volkswagen	GSY5DGDGXGH	Male	136	2212247	22222	46497	QTFW
<input type="checkbox"/>		W38 PRA	Blue	HJHJH	Volkswagen	GSY5DGDGXGH	Male	137	2212248	22222	46498	GWTTWE
<input type="checkbox"/>		W39 PRA	Blue	HJHJH	Volkswagen	GSY5DGDGXGH	Male	138	2212249	22222	46499	FWFWA
<input type="checkbox"/>		W40 PRA	Blue	HJHJH	Volkswagen	GSY5DGDGXGH	Male	139	2212250	22222	46500	AGEY
<input type="checkbox"/>		W41 PRA	Blue	HJHJH	Volkswagen	GSY5DGDGXGH	Male	140	2212251	22222	46501	agregaegea
<input type="checkbox"/>		W42 PRA	Blue	HJHJH	Volkswagen	GSY5DGDGXGH	Male	141	2212252	22222	46502	ETOKH
<input type="checkbox"/>		W43 PRA	Blue	HJHJH	Volkswagen	GSY5DGDGXGH	Male	142	2212253	22222	46503	KUKTT
<input type="checkbox"/>		W44 PRA	Blue	HJHJH	Volkswagen	GSY5DGDGXGH	Male	143	2212254	22222	46504	TRYRTHFX
<input type="checkbox"/>		W45 PRA	Blue	HJHJH	Volkswagen	GSY5DGDGXGH	Male	144	2212255	22222	46505	WGAA
<input type="checkbox"/>		W46 PRA	Blue	HJHJH	Volkswagen	GSY5DGDGXGH	Male	145	2212256	22222	46506	FFQFQFQ
<input type="checkbox"/>		W47 PRA	Blue	HJHJH	Volkswagen	GSY5DGDGXGH	Male	146	2212257	22222	46507	FQFQWQ
<input type="checkbox"/>		W48 PRA	Blue	HJHJH	Volkswagen	GSY5DGDGXGH	Male	147	2212258	22222	46508	QTFW
<input type="checkbox"/>		W49 PRA	Blue	HJHJH	Volkswagen	GSY5DGDGXGH	Male	148	2212259	22222	46509	GWTTWE

⌂ < 2 /167 > ✕ Import Import From CSV Import From Local Move To Delete Export

Search: License plate can be filtered according to keywords.

Total: Total number of license plate data in this group.

Click  to modify the corresponding license plate data information.

Modify

License Plate: W32 PRA

Color: Blue

Brand: HJHJH Model: Volkswagen

Owner: GSY5DGDGDXGH Gender: Male

ID Code: 131 Occupation: 22222

Phone Number: 2212242

Residence: 46492

Remark: KUKTT

Alarm Channel

Modify Exit

There are three ways to add license plate information: Import, Import From CSV and **Import From Local**.

Click **Import** button to manually add a single license plate information.

Import

License Plate

Color: Blue

Brand Model

Owner Gender: Male

ID Code Occupation

Phone Number

Residence

Remark

Alarm Channel

Import Exit

Click **Export** button to export the entire group information to the external U disk.

Alarm Channel: Set the channel to alarm after the license plate is detected and compared successfully.

Move to...: Check the check box of the license plate information and then click this button to transfer the license plate information to another group.

Delete: Check the check box of the license plate information and then click this button to delete the license plate information.

Click **Import From CSV** button to import a single piece or multiple pieces of data into the CVS table.

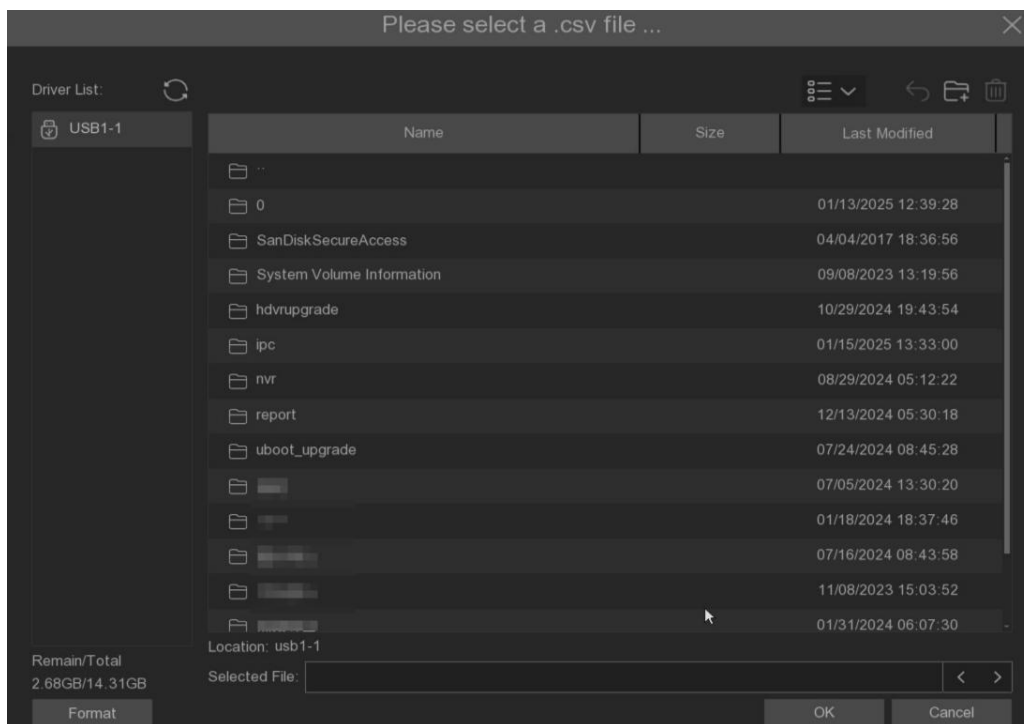

Click **Import From CSV** button to pop up the above interface, select the license plate file of CSV that needs to be imported, and click the OK button. The interface as shown as below picture.

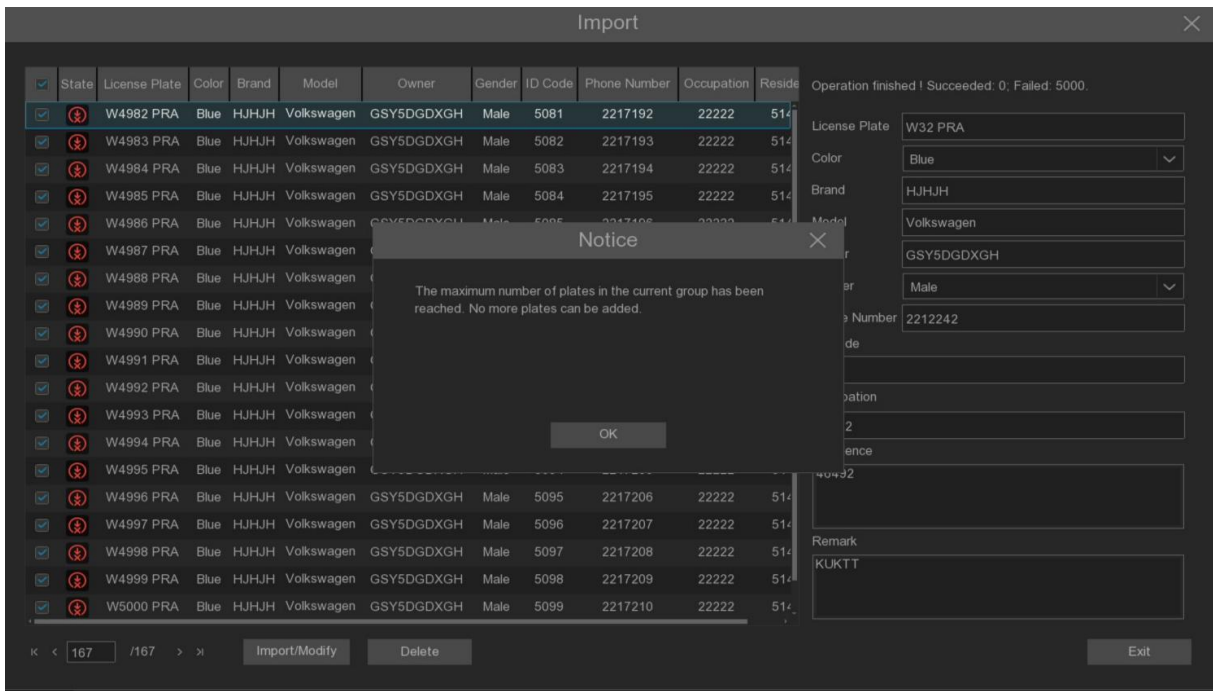

Click [Import/Modify](#) button to add the batch, or you can also select a single license plate information to modify it. When more than 5000 data are added, the message box appears as shown in the figure above, and the content is "the added data has reached the upper limit of the group".

Click [Import From Local](#) button to import the license plate information locally to the database.

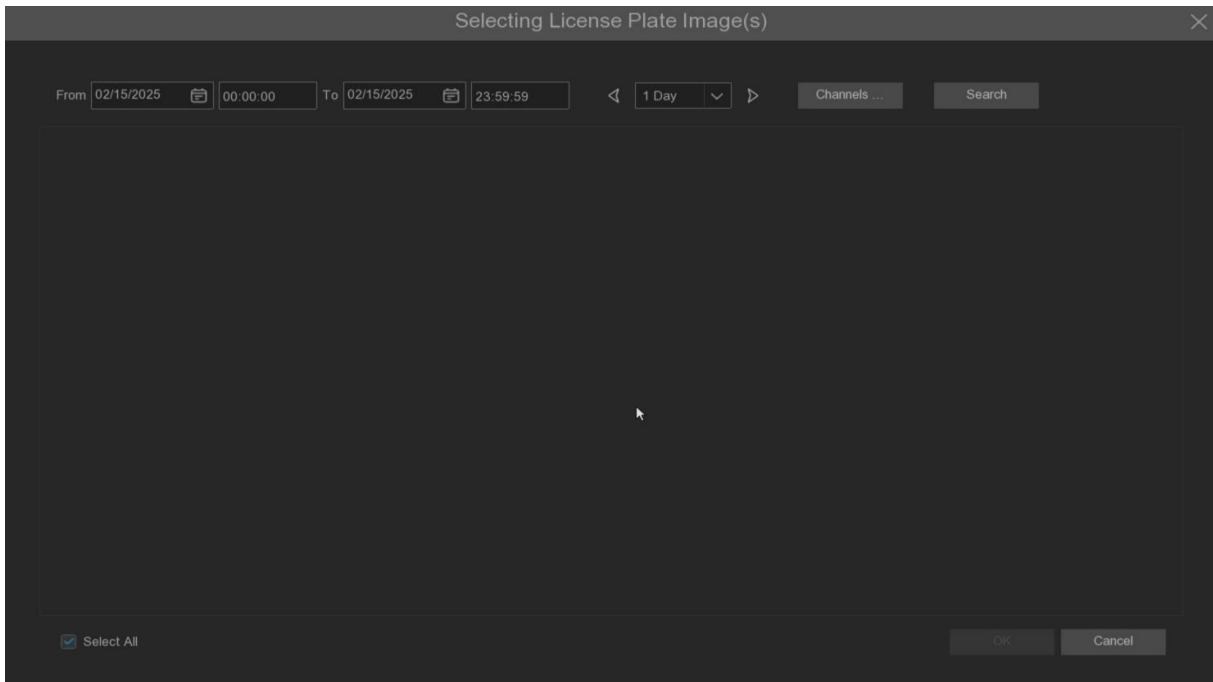



Select the date, duration and channel back point Search to search for the license plates saved by all the devices during this period.

Channels: License plate detection events triggered by each channel can be searched.

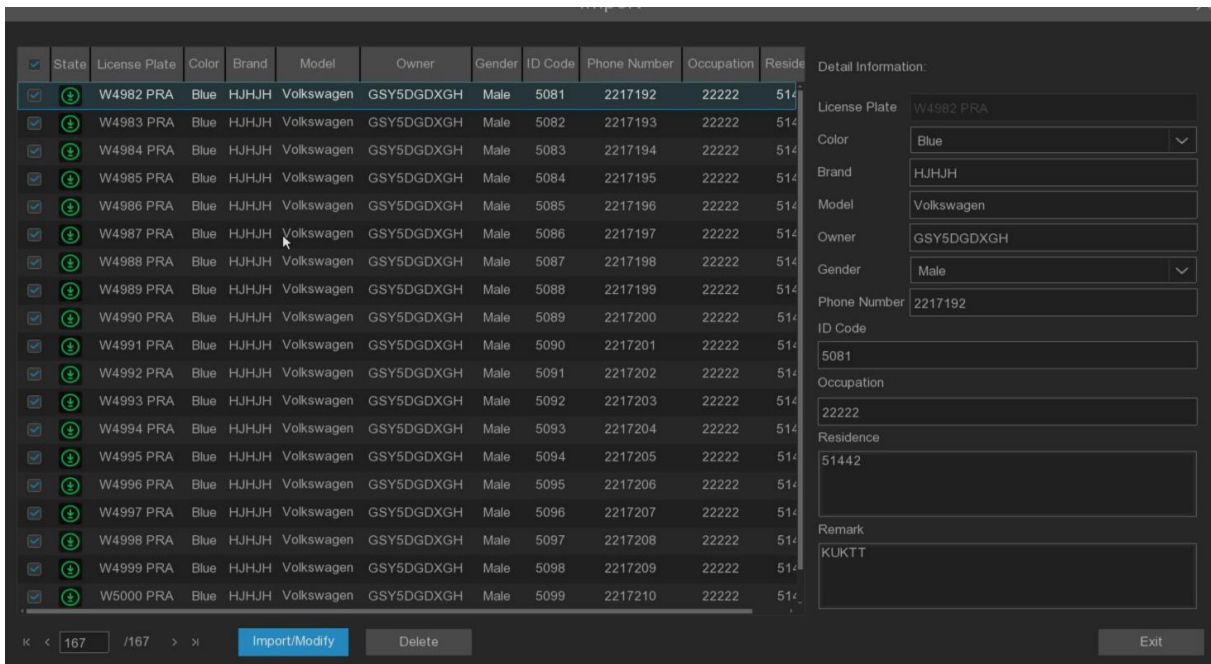
Select All: Select all the license plate information.



Click a piece of data to edit the license plate information. After editing, click the Import / Modify button to modify  it, if the  modification is successful. Will become.

Alarm: Open or close the license plate comparison alarm.

Policy: Set up the license plate group alarm countermeasures.

Fault-tolerant: Fault tolerance character. For example, when set to three characters, the license number of the white list in the group is B5945B, and when the license number of B734KB enters the monitoring area, an alarm is also triggered. That is, the detection license plate number has 0~5 characters and the database license plate number is different will alarm.

Alarm: Click  to enter the setting interface.

Alarm [Forbidden]							
Channel	Buzzer	Alarm Out	Email	FTP Picture Upload	Picture to Cloud	Voice Prompts	
CH1 (529+4210poe)	<input type="checkbox"/>	<input checked="" type="checkbox"/>	<input type="checkbox"/>	<input type="checkbox"/>	<input type="checkbox"/>	<input type="checkbox"/>	
CH2 (30kg824)	<input type="checkbox"/>	<input checked="" type="checkbox"/>	<input type="checkbox"/>	<input type="checkbox"/>	<input type="checkbox"/>	<input type="checkbox"/>	
CH3 (Camera)	<input type="checkbox"/>	<input checked="" type="checkbox"/>	<input type="checkbox"/>	<input type="checkbox"/>	<input type="checkbox"/>	<input type="checkbox"/>	
CH4 (Camera823)	<input type="checkbox"/>	<input checked="" type="checkbox"/>	<input type="checkbox"/>	<input type="checkbox"/>	<input type="checkbox"/>	<input type="checkbox"/>	
CH5 (111112222333344445555666667)	<input type="checkbox"/>	<input checked="" type="checkbox"/>	<input type="checkbox"/>	<input type="checkbox"/>	<input type="checkbox"/>	<input type="checkbox"/>	
CH6 (338g)	<input type="checkbox"/>	<input checked="" type="checkbox"/>	<input type="checkbox"/>	<input type="checkbox"/>	<input type="checkbox"/>	<input type="checkbox"/>	
CH7 (30...)	<input type="checkbox"/>	<input checked="" type="checkbox"/>	<input type="checkbox"/>	<input type="checkbox"/>	<input type="checkbox"/>	<input type="checkbox"/>	
CH8 (5...)	<input type="checkbox"/>	<input checked="" type="checkbox"/>	<input type="checkbox"/>	<input type="checkbox"/>	<input type="checkbox"/>	<input type="checkbox"/>	
CH9 (III)	<input type="checkbox"/>	<input checked="" type="checkbox"/>	<input type="checkbox"/>	<input type="checkbox"/>	<input type="checkbox"/>	<input type="checkbox"/>	
CH10 (Ive)	<input type="checkbox"/>	<input checked="" type="checkbox"/>	<input type="checkbox"/>	<input type="checkbox"/>	<input type="checkbox"/>	<input type="checkbox"/>	
CH11 (529-850)	<input type="checkbox"/>	<input checked="" type="checkbox"/>	<input type="checkbox"/>	<input type="checkbox"/>	<input type="checkbox"/>	<input type="checkbox"/>	
CH12 (16>z<338g)	<input type="checkbox"/>	<input checked="" type="checkbox"/>	<input type="checkbox"/>	<input type="checkbox"/>	<input type="checkbox"/>	<input type="checkbox"/>	
CH13 (Camera)	<input type="checkbox"/>	<input checked="" type="checkbox"/>	<input type="checkbox"/>	<input type="checkbox"/>	<input type="checkbox"/>	<input type="checkbox"/>	
CH14 (30...)	<input type="checkbox"/>	<input checked="" type="checkbox"/>	<input type="checkbox"/>	<input type="checkbox"/>	<input type="checkbox"/>	<input type="checkbox"/>	
CH15 (52...)	<input type="checkbox"/>	<input checked="" type="checkbox"/>	<input type="checkbox"/>	<input type="checkbox"/>	<input type="checkbox"/>	<input type="checkbox"/>	
CH16 (1200)	<input type="checkbox"/>	<input checked="" type="checkbox"/>	<input type="checkbox"/>	<input type="checkbox"/>	<input type="checkbox"/>	<input type="checkbox"/>	

Buzzer: Set whether the device emits a beep after the alarm occurs, and the beep lasts for 10 seconds.

Alarm Out: Set whether the alarm output is linked after the alarm occurs. Click the setting button to configure the alarm output source.

Email: Set whether to send an email to the mailbox after the alarm occurs.

FTP Picture Upload: Set whether to upload the alarm grab map to the configured FTP server after the license plate comparison alarm occurs.

Picture to Cloud: Set whether to upload the alarm grab map to the configured cloud storage server after the license plate comparison alarm occurs.

Voice Prompts: Set whether to broadcast by voice after the license plate comparison occurs.

Detailed setting can refer to **5.3.4 voice prompts**.

Alarm Schedule: Set the time period for each camera channel to enable license plate alignment.

Referring to **5.2.1.1 Video schedule**.

Alarm Channel: Set the channel for the license plate group to enable the license plate comparison alarm.

5.4.2.4 Analysis and configuration of personnel frequency

The device supports the personnel frequency analysis function, which can automatically monitor and count the occurrence frequency of personnel in the designated monitoring area, providing data support for the people flow analysis scene.

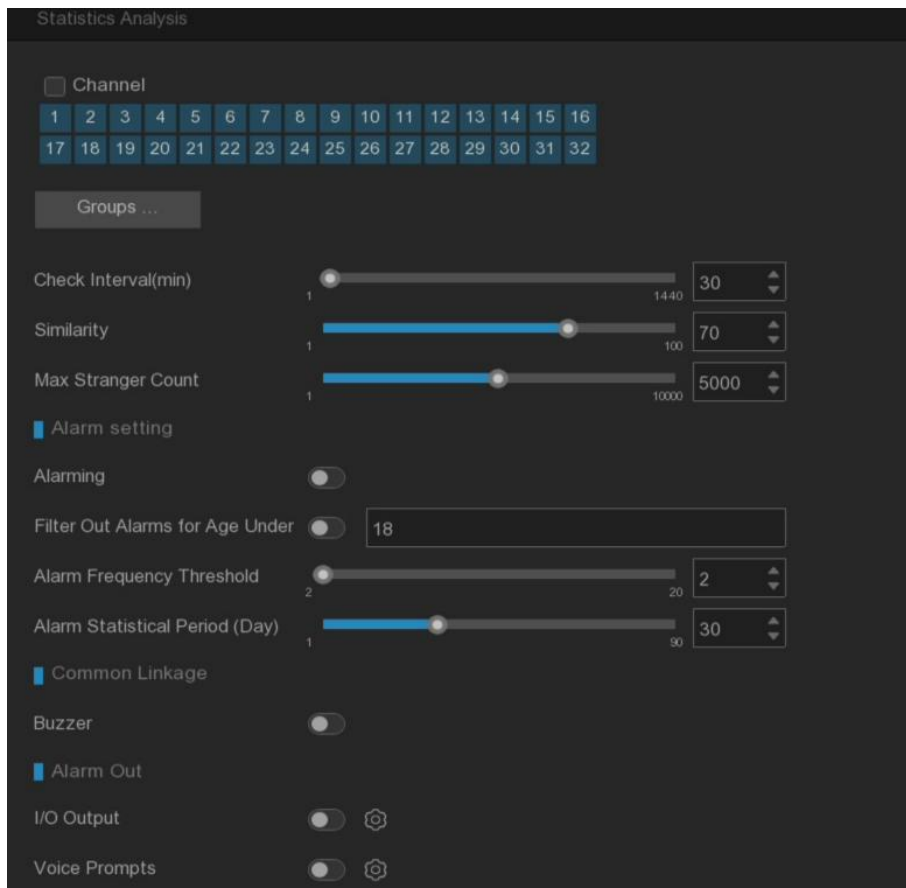

Channel: Check the channel for personnel frequency analysis, and the personnel identified on the failed channel will not be included in the statistics.

Groups...: Check the face list group for personnel frequency analysis.

Alarm Check Interval (min): Frequency interval time, set the interval time between two adjacent

appearances of the same person. If the same person is identified multiple times during the frequency interval, the frequency count of the person will not increase.

Similarity: Similarity setting, the identified person and the count statistics of the person after meeting the threshold.

Max Stranger Count: The device supports the maximum number of strangers counted.

Alarming: Personnel frequency alarm switch, send alarm when the personnel frequency reaches the preset frequency threshold.

Filter Out Alarms for Age Under: Minor alarm filtering, When the age of the identified person is lower than the set age, filter the person without alarm.

Alarm Frequency Threshold: Warning frequency threshold.

Alarm Statistical Period (Day): alarm statistics period, only the frequency of personnel in the preset period.

Buzzer: Set whether the equipment will beep after the personnel frequency alarm occurs for 10 seconds.

I/O Output: Set whether the alarm output after the frequency alarm occurs. Click the right setting button to configure the alarm output source.

Voice Prompts: Set whether to broadcast after the personnel frequency alarm. Reference to **5.3.4**

Voice Prompts.

5.4.2.4 Model configuration

This menu can configure the face recognition model, support the selection of NVR local model or camera model.

Auto select face recognition model

Device/Channel	Face Recognition Model	Face Detection Model	Enable Face Recognition
Local	V0.5.0.0.3-release	-----	<input type="checkbox"/>
CH1 (529+4210poe)	V0.5.0.0.3-release	V0.5.1.2.2-release	<input type="checkbox"/>
CH2 (30kq824)	V0.4.0.0.3-release	V0.4.1.2.2-release	<input type="checkbox"/>
CH3 (Camera)	V0.4.0.0.3-release	V0.4.1.2.2-release	<input checked="" type="checkbox"/>
CH4 (Camera823)	V0.5.0.0.2-release	V0.5.1.2.1-release	<input type="checkbox"/>
CH5 (1111122222333334444455555666667)	V0.5.0.0.2-release	V0.5.1.2.1-release	<input type="checkbox"/>
CH6 (338g)	V0.4.0.0.3-release	V0.4.1.2.2-release	<input type="checkbox"/>
CH8 (529+4210one)	V0.5.0.0.3-release	V0.5.1.2.2-release	<input type="checkbox"/>
CH9 (III)	V7.8.0.0.1-beta	V7.8.1.7.1-beta	<input checked="" type="checkbox"/>
CH10 (live)	V0.4.0.0.3-release	V0.4.1.2.2-release	<input type="checkbox"/>
CH11 (529-850)	V0.5.0.0.3-release	V0.5.1.2.2-release	<input type="checkbox"/>
CH12 (16>z<338g)	V0.4.0.0.3-release	V0.4.1.2.2-release	<input type="checkbox"/>
CH13 (Camera)	V0.4.0.0.3-release	V0.4.1.2.2-release	<input type="checkbox"/>
CH15 (529-850)	V0.5.0.0.3-release	V0.5.1.2.2-release	<input type="checkbox"/>
CH16 (1200)	V0.5.0.0.3-release	V0.5.1.2.2-release	<input type="checkbox"/>
CH17 (529+11)	V0.5.0.0.3-release	V0.5.1.2.2-release	<input type="checkbox"/>
CH18 (338g)	V0.4.0.0.3-release	V0.4.1.2.2-release	<input type="checkbox"/>

5.4.3 Statistical analysis

5.4.3.1 Face recognition statistics

In the face recognition statistics, the statistics can be made on all the faces detected in a period of time, and reflected in the way of a statistical chart.

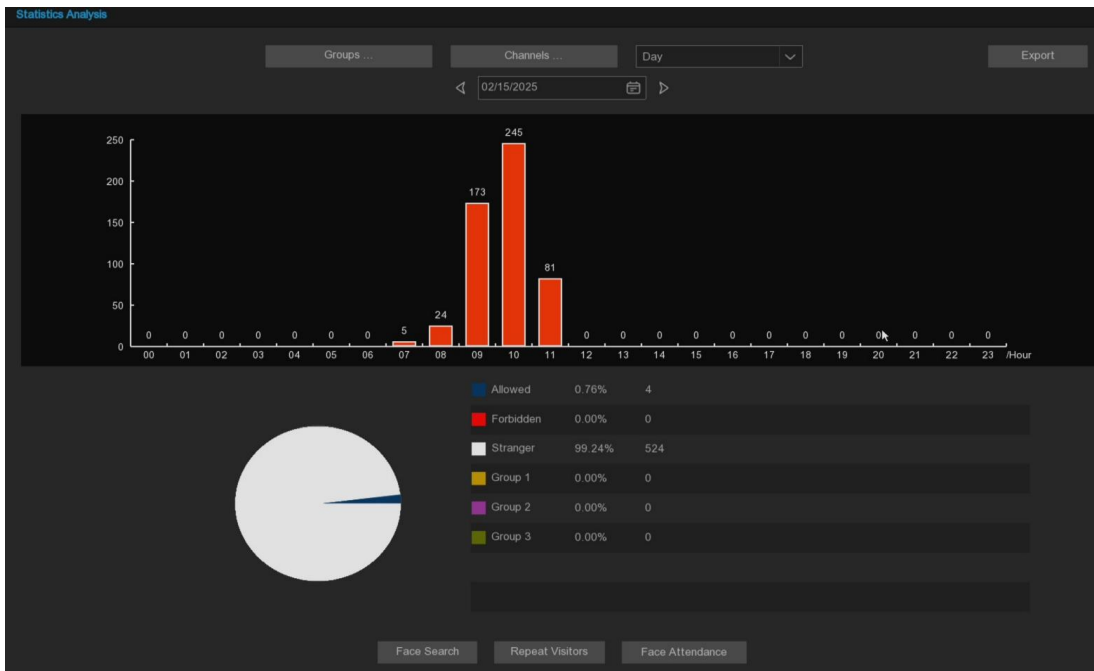

After selecting Groups, Channels, date, and statistical time, the statistical results will be given directly out. Click [Export](#) to import the data to the U disk.

Face Search: Click the face search button to jump directly to the intelligent playback face search page.

Repeat Visitors: Click the face statistics button to jump directly to the intelligent replay repeat customer page.

Face Attendance: Click the face attendance button to jump directly to the intelligent playback face attendance page.

5.4.3.2 Pedestrian and Vehicle Statistics

In the pedestrian and vehicle statistics, all of detected pedestrian and vehicle that appear in a period of time can be counted and reflected in the form of statistical charts.

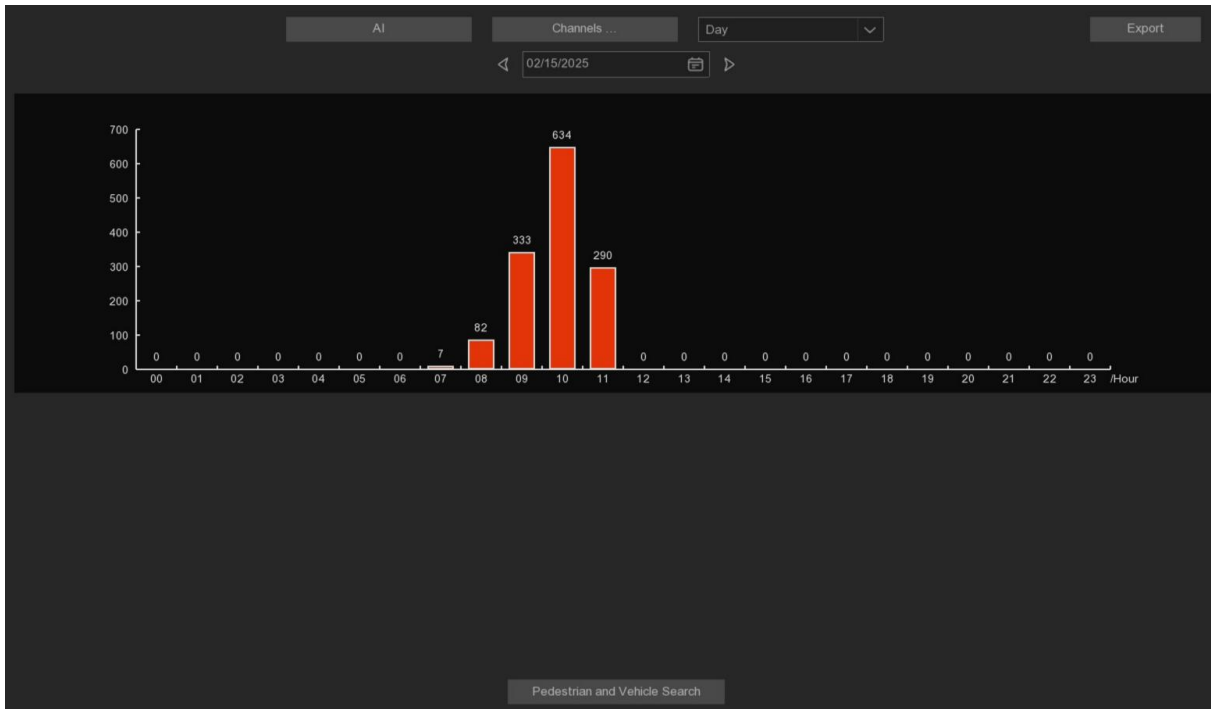

After selecting the type, Channels, date and statistical time in the AI, the statistical results will be given directly out.

Pedestrian and Vehicle Search: Click Pedestrian & Vehicle button to jump directly to the intelligent playback pedestrian & Vehicle page.

5.4.3.3 Cross Counting Statistics

In crossing counting statistics, the number of times in and out of a period of time can be counted, and reflected in the way of statistical chart.

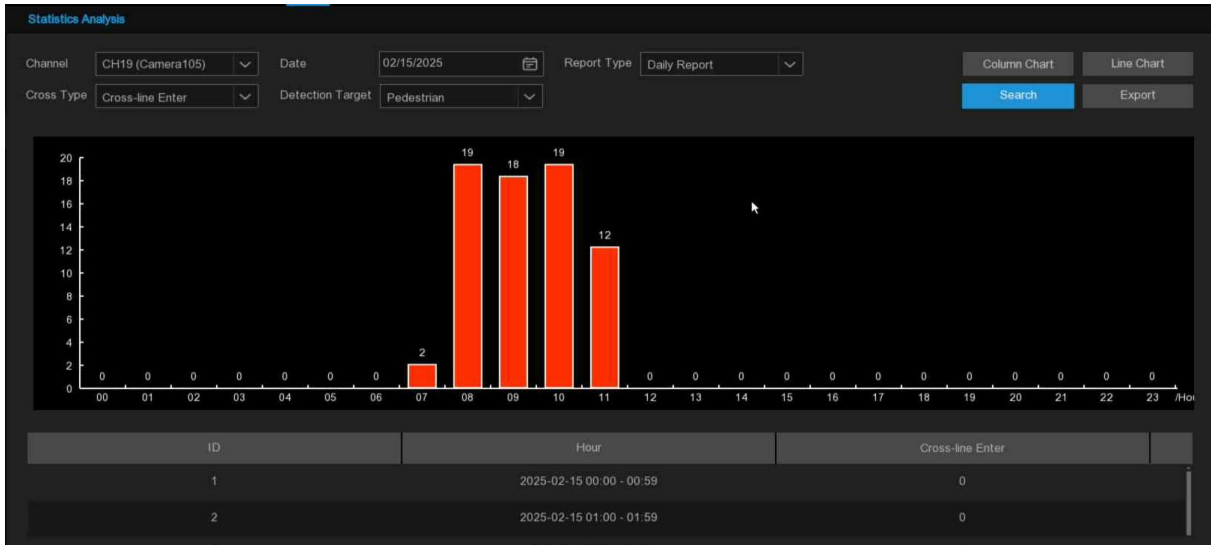

Channel: Select the channel that you want to search.

Date: Select the date that you want to search.

Report Type: Select the report type, including Daily Report, Weekly Report, Monthly Report, and Annual Report four types of report.

Cross Type: There are two types of penetration: Cross-line Enter and Cross-line Exit.

Detection Target: Select the detection type that triggers the Cross Counting, with four options: Motion, Person, Motor Vehicle, and Non-motorized Vehicle.

Click **Search** button to query for data.

Export: Results to export the external U disk.

Column Chart: Select the bar chart to display.

Line Chart: Select the line diagram to display.

5.4.3.4 Heat Map Statistics

In the heat map statistics, the frequent activity of some areas during a period of time can be counted and reflected in the way of statistical map.



Channel: Select the channel that you want to search for.

Date: Select the date that you want to search.

Start Time: Select the start time.

End Time: Select the end time.

Report Type: Select the report type, including Daily Report, Weekly Report, Monthly Report, and Annual Report four types of report.

Click **Search** button to search for data

Export: Results to export the external U disk.

Spatial Heatmap: Select the spatial distribution map to display.

Time Heatmap: The selection time distribution diagram is shown.

The selection time distribution map has no choice of Start Hour and End Hour.

Spatial density legend: Comparison of spatial density levels.

5.5 Network

5.5.1 General

5.5.1.1 General Configuration

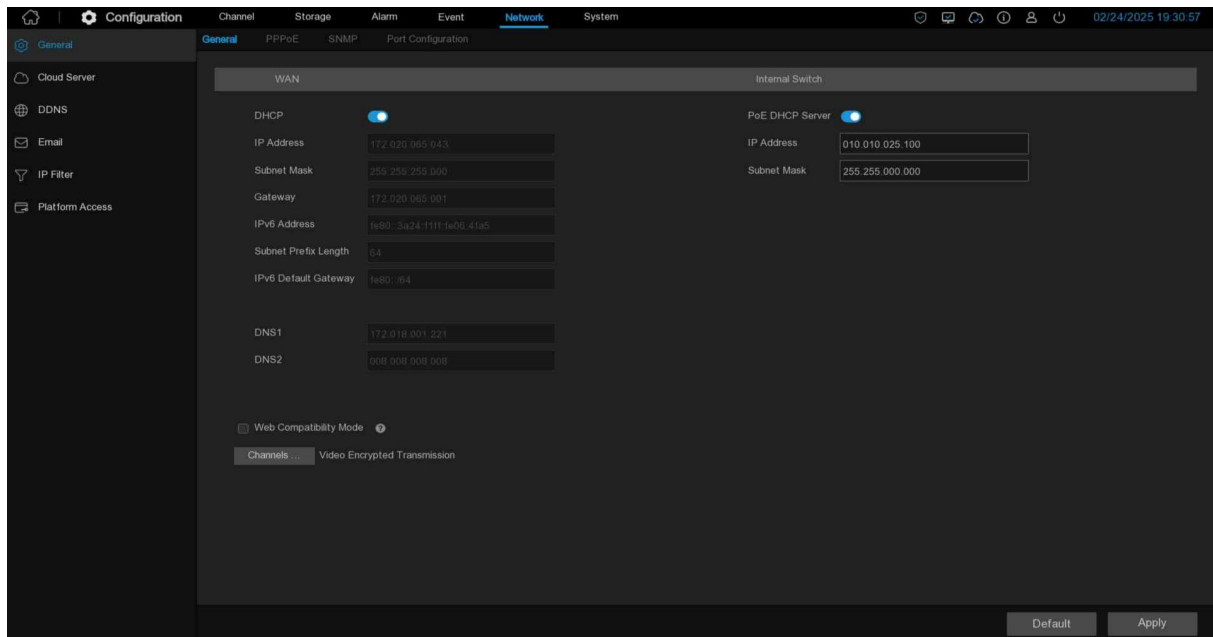

If the network connected to the device has a DHCP service, check the DHCP box, and the DHCP service will automatically assign all network parameters to the device. or manually set the following network parameters:

IP Address: IPV 4 address is the identity of NVR in the network. It consists of four sets of numbers between 0 and 255, separated by periods. For example, "192.168.001.100".

Subnet Mask: A subnet mask is a network parameter that defines the range of IPV 4 addresses that can be used in the network. Subnet addresses also consisted of four sets of numbers, separated by periods. For example, "255.255.000.000"

Gateway: The IPV 4 gateway address of the network where the device is located, the default is:
192.168.001.001.

IPv6 Address: The IPv6 address is the identity of the NVR in the network. It consists of eight sets of numbers between 0 and FFFF, separated by colons. For example, "ABCD: EF01:2345:6789: ABCD: EF01:2345:6789".

IPv6 Gateway: The IPV 6 gateway address of the network where the device is located.

DNS 1 / DNS 2: DNS 1 is the primary DNS server, and DNS 2 is the standby DNS server. Usually just enough to enter the DNS 1 server address.

Web Compatibility Mode: If the selected browser does not support web-side access to the device, please enable web compatibility mode. Compatible mode will choose the insecure encryption algorithm, please choose carefully.

Channels...: Set the channel to the client to encrypt the transmission video stream.

POE DHCP Server: IP address allocation for the camera connected by the PoE port.(Note: This option is shown with only POE)

5.5.1.2 PPPoE

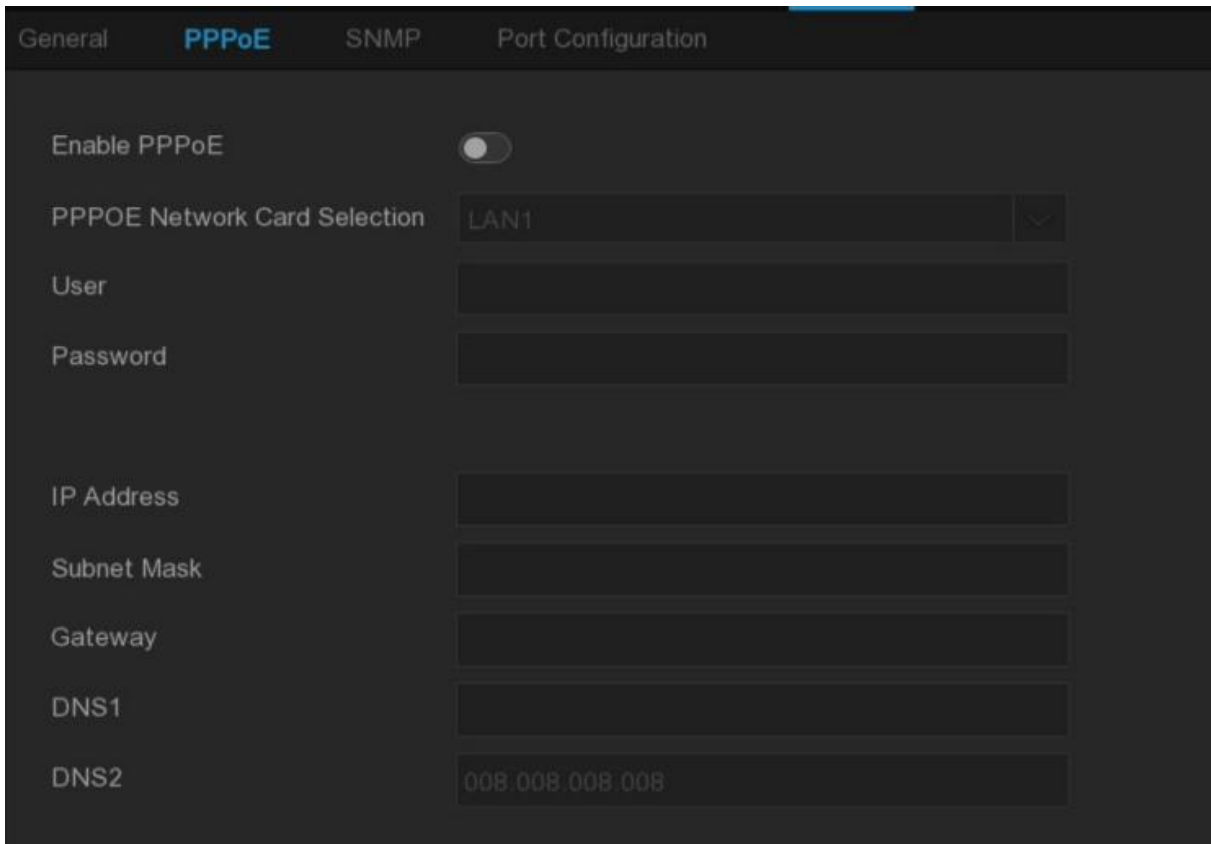

The screenshot shows a web interface for configuring PPPoE. At the top, there are tabs for 'General', 'PPPoE', 'SNMP', and 'Port Configuration'. The 'PPPoE' tab is selected. Below the tabs, there are several configuration options:

- Enable PPPoE:** A toggle switch that is currently turned on.
- PPPOE Network Card Selection:** A dropdown menu showing 'LAN1'.
- User:** A text input field.
- Password:** A text input field.
- IP Address:** A text input field.
- Subnet Mask:** A text input field.
- Gateway:** A text input field.
- DNS1:** A text input field.
- DNS2:** A text input field containing the value '008.008.008.008'.

PPPoE networking is enabled, and devices can connect to the network through dial-up Internet access.

Select the Enable PPPoE box and enter the user name and password (the user name and password are available from the carrier).

Click [Apply](#) to save, and the system restart will automatically dial the number. After successful dialing, the network information can be displayed on this page.

5.5.1.3 SNMP

The user can obtain the device parameters and receive the device through the SNMP protocol.

Enable SNMP	<input checked="" type="checkbox"/>
SNMP Version	V1
SNMP Port	00161
Read Community	Pub-Group
Write Community	Pte-Group
Trap IP Address	127.000.000.001
Trap Port	00162

Note:

1. Before setting SNMP parameters, users need to download SNMP software and receive the information of the device through the SNMP port, such as software version number, device type, channel IP, resolution, frame number, etc.

2. Set the Trap management address, and the device can send alarm and abnormal information to the management station.

5.5.1.4 Wireless Configuration

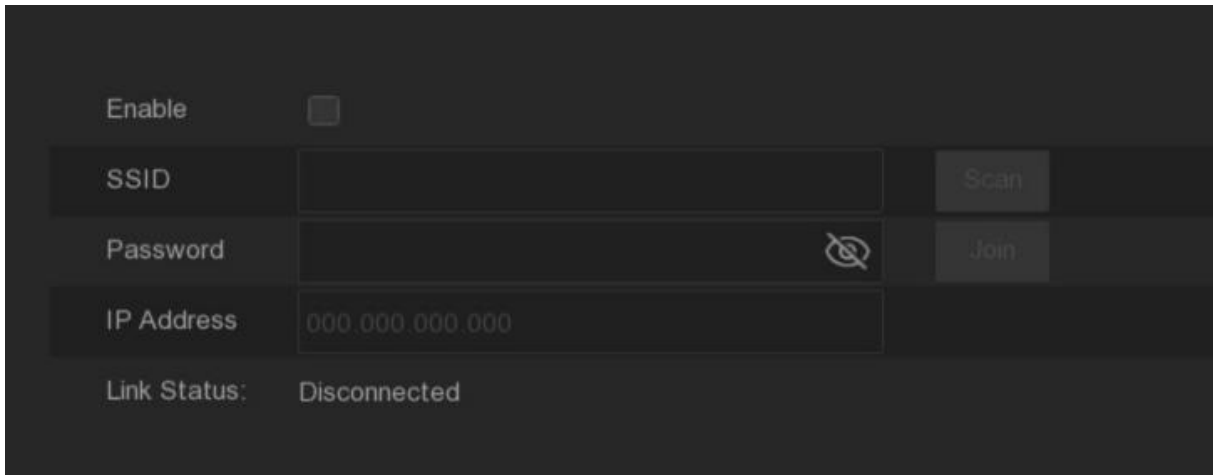

After the device is connected to the WIFI dongle, which can be configured to connect to WiFi access to the Internet.

Enable: Wireless function to enable the switch

SSID: WiFi name, click the Scan button to search for nearby available WiFi routes.

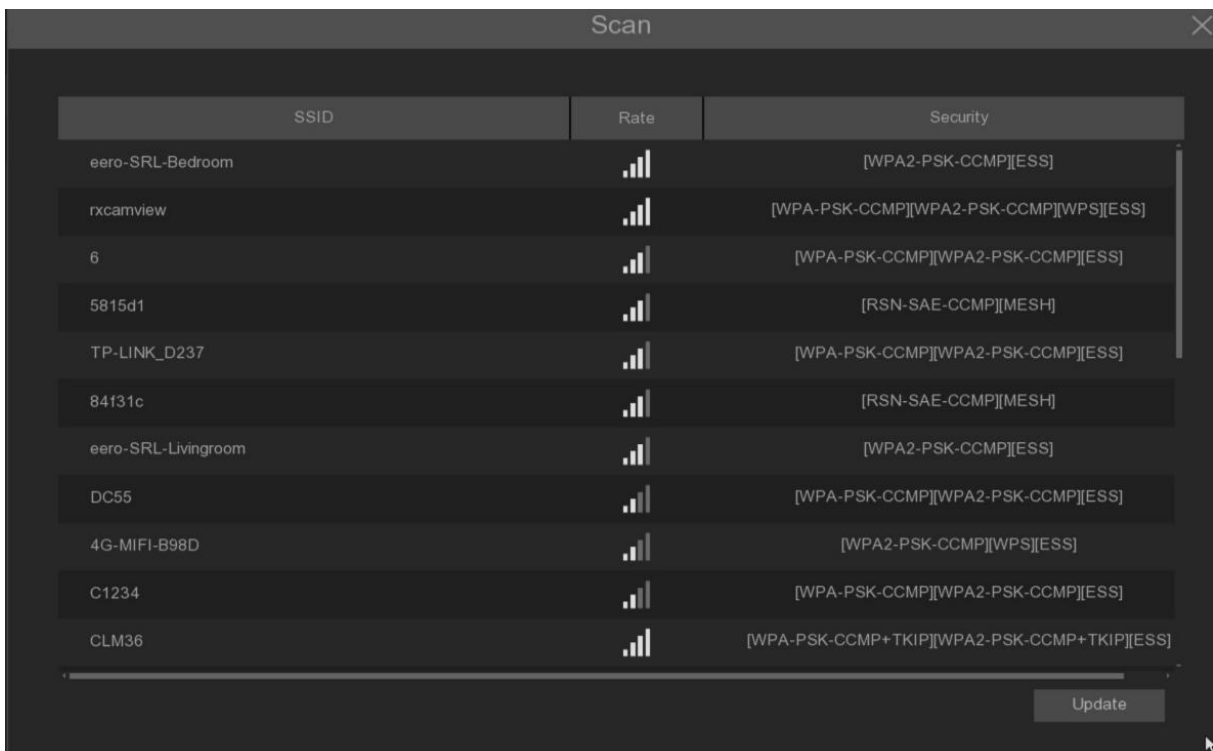

When the list selects the WiFi that you want to connect to, double-click the WiFi name that you want to connect to

Rate: Signal intensity.

Security: Security protocol information used by WiFi.

Update: Refresh the list.

Password: Passcode for connecting the WiFi route.

IP Address: The IP address obtained after successfully connecting to the WiFi route.

Link Status: The connection status.

Default: Page configuration to restore the default.

Apply: Changes to the application configuration.

5.5.1.5 port configuration

No.	Service	Protocol	Internal Port	External Port	UPNP Status	Mapping Strategy	UPNP
1	Http	TCP	00080	00080	Inactive	Auto	<input type="checkbox"/>
3	RTSP	TCP	00554	00554	Inactive	Auto	<input type="checkbox"/>
4	Https	TCP	00443	00443	Inactive	Auto	<input type="checkbox"/>

Instruction:
 rtsp://ip.port/rtsp/streaming?channel=A&subtype=B
 A:01(ch1),02(ch2)...
 B:0(main stream),1(sub stream)

External IP

P2P Switch

Direct Camera Web Access

HTTP / RTSP / HTTPS: Set the port to access the device through the http / https / rtp protocol

UPNP (Universal Plug and Play): UPNP full name universal Plug and Play (Universal Plug and Play), enables UPNP NAT conversion rules, realizes automatic port mapping, allows external computers to access Intranet devices, and makes the network work efficiently. The UPNP functionality requires the router support. Before setting the UPNP function, please set the router first, and set the parameters such as the Intranet IP address, subnet mask and gateway matching with the router in the basic network configuration.

Mapping Strategy: Select Manual, users can edit and set the external port (port on the router). If automatic, randomly map an external port (different from the internal port).

External IP: The external network outlet of the equipment is ip

P2P Switch: P2P switch, after off, the user will not be able to access the device using P2P ID.

Direct Camera Web Access: When enabled, you can directly access the WEB page of the IPC by hyperlink on the Web side of the NVR.

5.5.2 Cloud services

By enabling the cloud service function, setting up the region, generating the dynamic QR code, using the CybVU APP to scan this QR code to add the device to the APP for management.

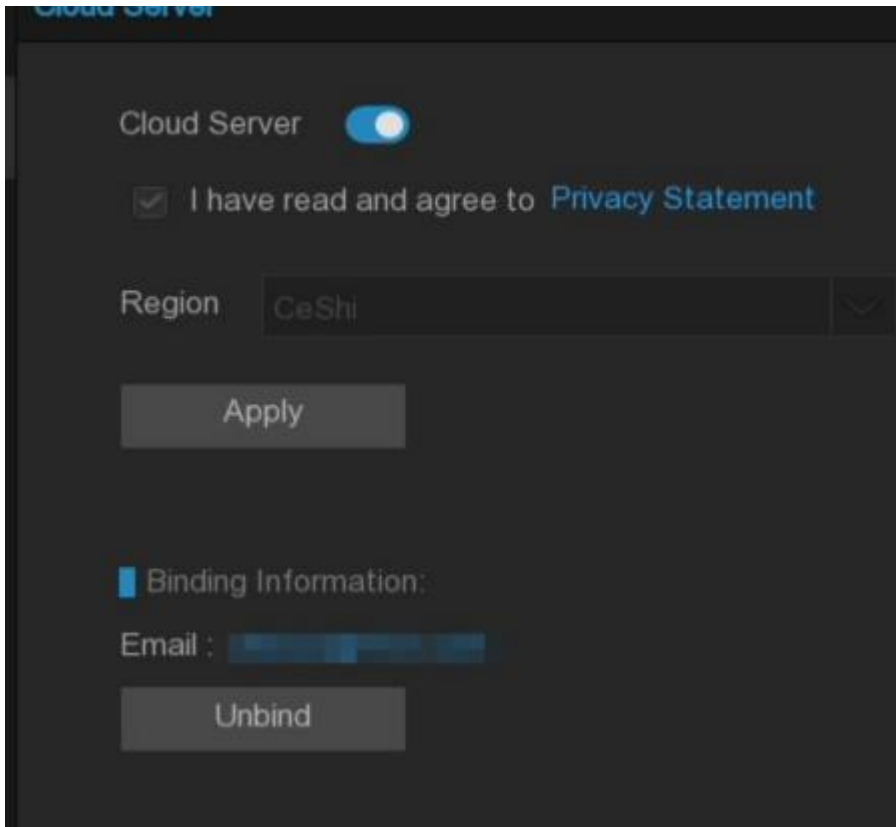

Cloud Services: Cloud service switch.

Privacy Statement: To enable cloud services, first read and agree to the privacy statement.

Region: Select the cloud service area (consistent with the CybVu APP registration area)

QR code display: After enabling cloud service and setting the area, dynamic QR code will be automatically generated (QR code lasts for 300s, automatically invalid after expiration, need to be reacquired). Using the CybVu APP scanning QR code, the camera can be added to the APP for management.

Unbind: Click the unbinding button to unbind the camera with the CybVu APP account. After unbinding, the device on the APP is offline and inaccessible.

Note: The cloud service function needs to communicate with the cloud server, so the device needs to be connected to the Internet when using this function.

5.5.3 DDNS (Dynamic Domain Name Server)

This menu is used to configure the DDNS parameters. Using DDNS, through the domain name, can effectively solve the trouble caused by dynamic IP to access the device. To use DDNS, first need to open an account on the web page of the DDNS service provider.

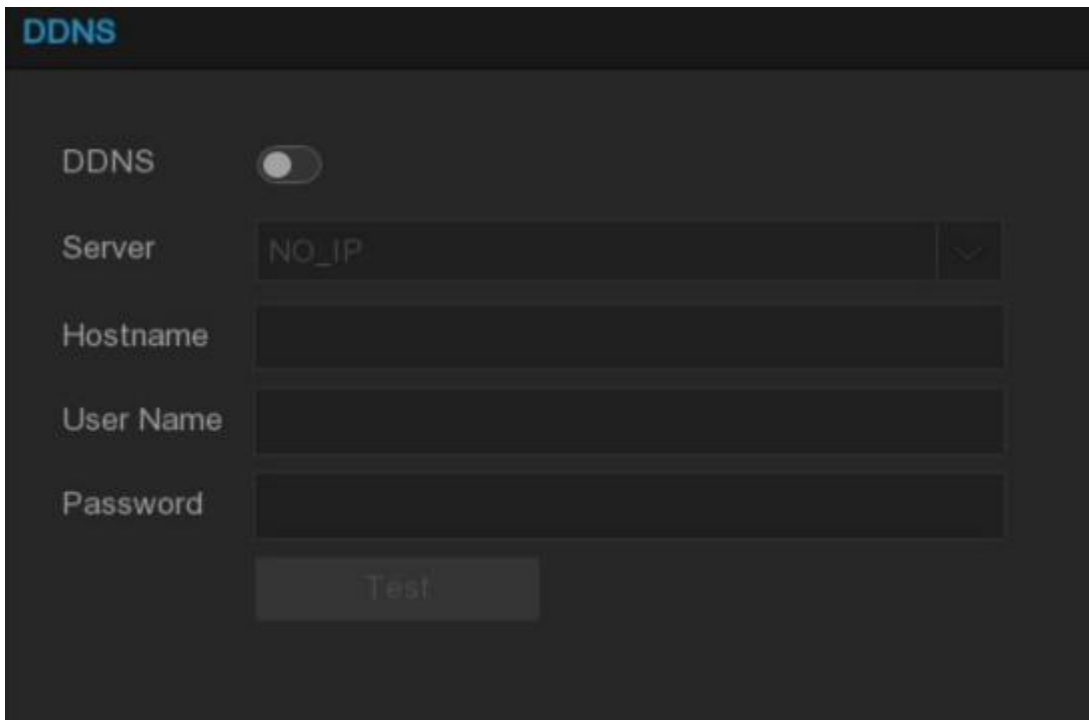

The screenshot shows the DDNS configuration page. It features a dark theme with light-colored text. At the top left, the word "DDNS" is displayed in a blue font. Below this, there is a toggle switch for "DDNS". Underneath the toggle are four input fields: "Server" (a dropdown menu currently showing "NO_IP"), "Hostname", "User Name", and "Password". At the bottom of the form is a "Test" button.

DDNS: Check to enable DDNS.

Server: Select the preferred DDNS server (DYNDNS, NO_IP, CHANGEIP, DNSEXIT).

Domain: Enter the domain name created on the webpage of the DDNS service provider. When connecting remotely to an NVR via a PC, this is the address that you need to type in the URL box.

User / Password: Enter the user name and password obtained when creating an account on the DDNS service provider's webpage.

After entering all the parameters, click Test to test the DDNS settings. If the test result is Network inaccessible or DNS wrong, check whether the network is normal or whether the DDNS information is correct.

When the user applies for a dynamic domain name service, it can use the browser to remotely access NVR through the domain name in the form of http: / / domain name: mapped http port number. When using DDNS domain name to access NVR, it is necessary to confirm that the port and the current IP are normally connected on the public network, and the server address / host name / user name / password / setting is consistent with the NVR terminal setting.

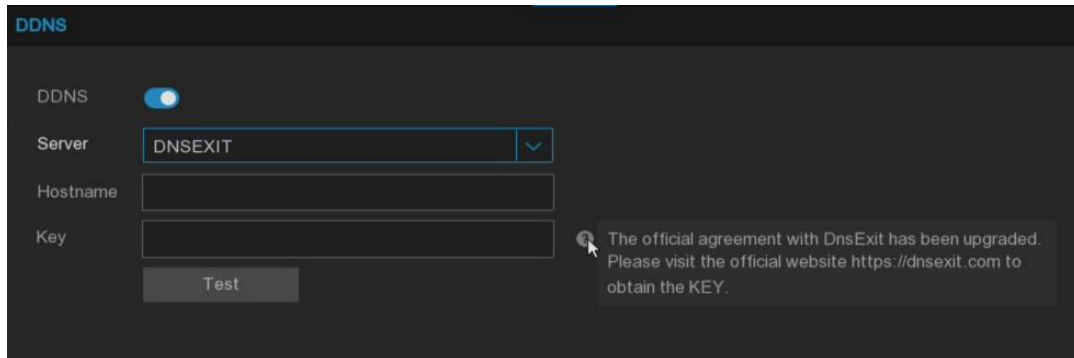

Note: DNSEXIT The domain name provider has updated the docking protocol, and the new protocol no longer supports the verification of the user name and password. You need to log in to the original account through the official website and obtain the key (such as: yUS5qMHQuPlJr4jHtoMuXDO883BqsO)

The previous version is authenticated by the password. If the external network IP changes, the DNSEXIT domain name will not be used. It must be updated to version 8.2.4.1 to go to the DNSEXIT official website to get key, and the domain name can be used normally after setting.

5.5.4 Email

This menu configconfigure email parameters. If you need to receive an alarm notification on your email when an alert is triggered, complete these settings.

5.5.4.1 Email Configuration

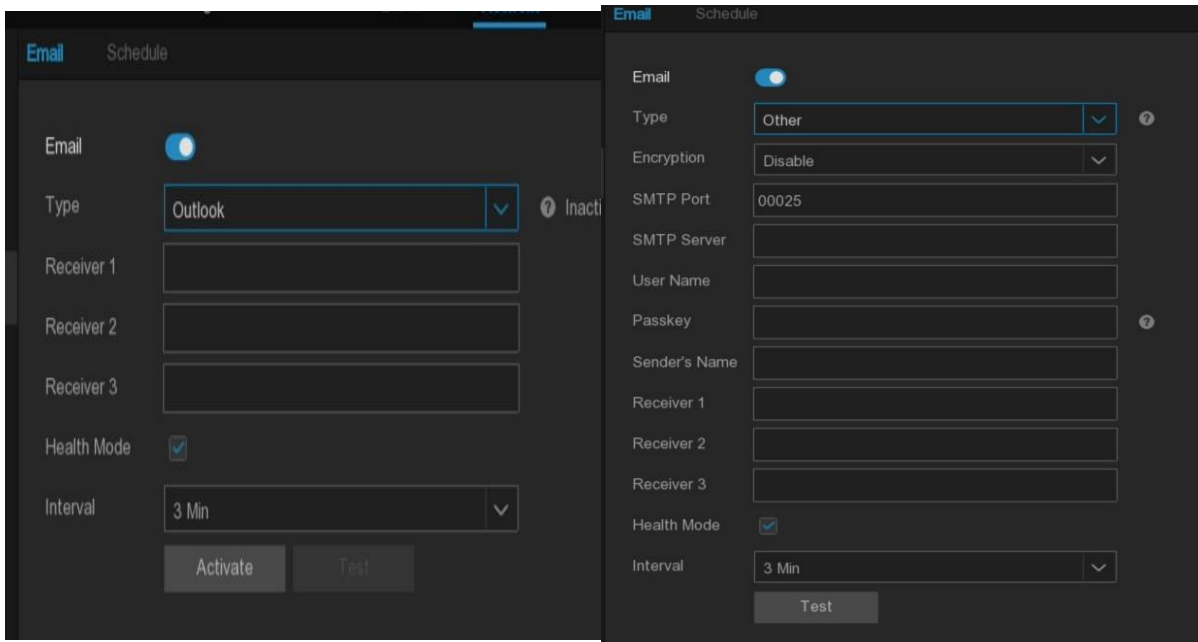

Email: Turn on the switch to enable it

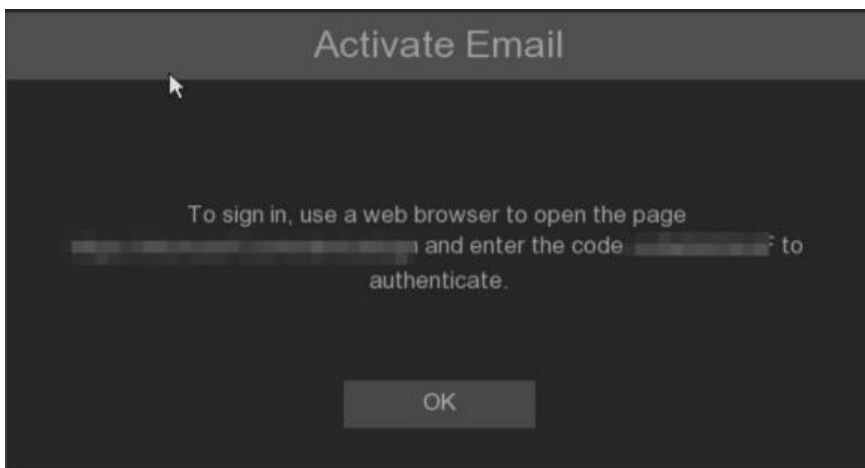

Type: The mailbox type, you can choose the Outlook mailbox or the Other mailbox. If you need to click Activate, enter the authorization code according to the pop-up web page address for activation. It can be used successfully. If you use other mailbox, you need to enter the email address and password for activation.

Encryption: Enable if the e-mail server requires SSL or TLS validation. If not sure, set it to Automatic. **SMTP Port:** Enter the SMTP port for the e-mail server.

SMTP Server: Enter the SMTP server address for the e-mail message.

User Name: Enter the email address

Password: Enter your email password

Receiver 1~3: Enter the email address to which to receive an event notification from the NVR.

Health Mode: Health mode, enable Interval function if checked. If not checked, the Interval function will be unavailable, NVR alarm to the mailbox, for license plate and face recognition, you will receive the foreground map and background picture of the alarm picture.

Interval: The time interval between notification messages to configure NVR.

To ensure that all the settings are correct, click on Test Email. A test email is sent to the Inbox, and if the test email is received, the configured parameters are correct.

5.5.4.2 Email Schedule

Configure the time period and refer to 5.2.1.1 Record schedule.

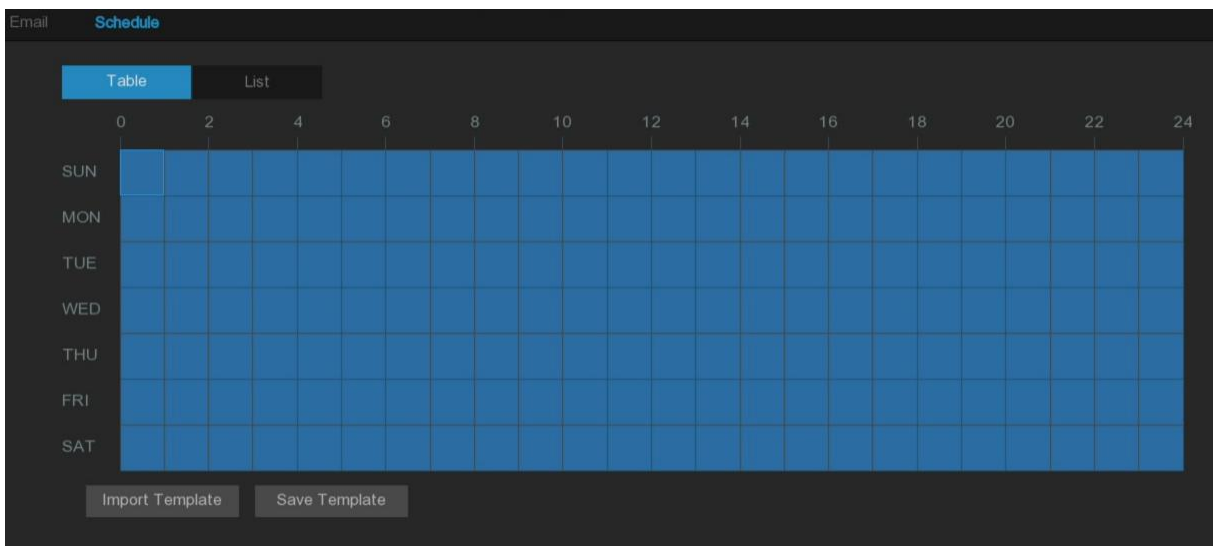

5.5.5 IP filter

The IP filter function can set the black and white list, when the white list is enabled, only the IP in the list is allowed to access the device. when the blacklist is enabled, the IP in the list will not be allowed to access the device.

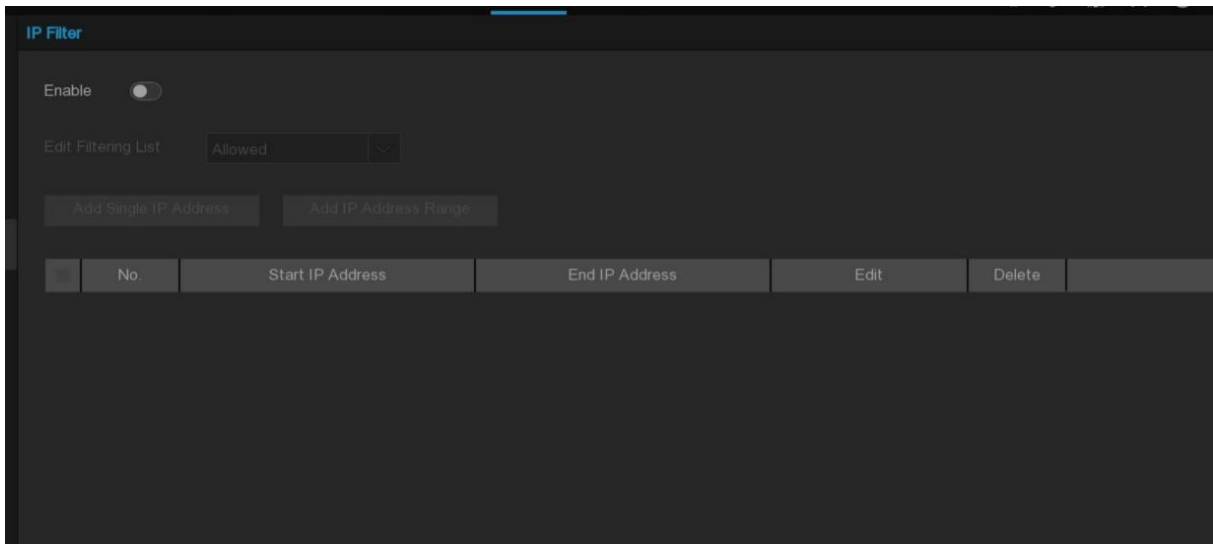

Enable: Turn the filter function on or off. When enabled, you can choose to enable Blacklist or whitelist.

Edit Filtering List: Select the list (blacklist or whitelist) to set.

Add Single IP Address: Add a single IP address.

Add IP Address Range: Add the IP address atmosphere.

Start Address: Enter the starting address.

End Address: Enter the end address.

5.5.6 Platform Access

5.5.6.1 Onvif

Opening this function will allow the device to be connected as a server by a third-party platform through the ONVIF protocol.

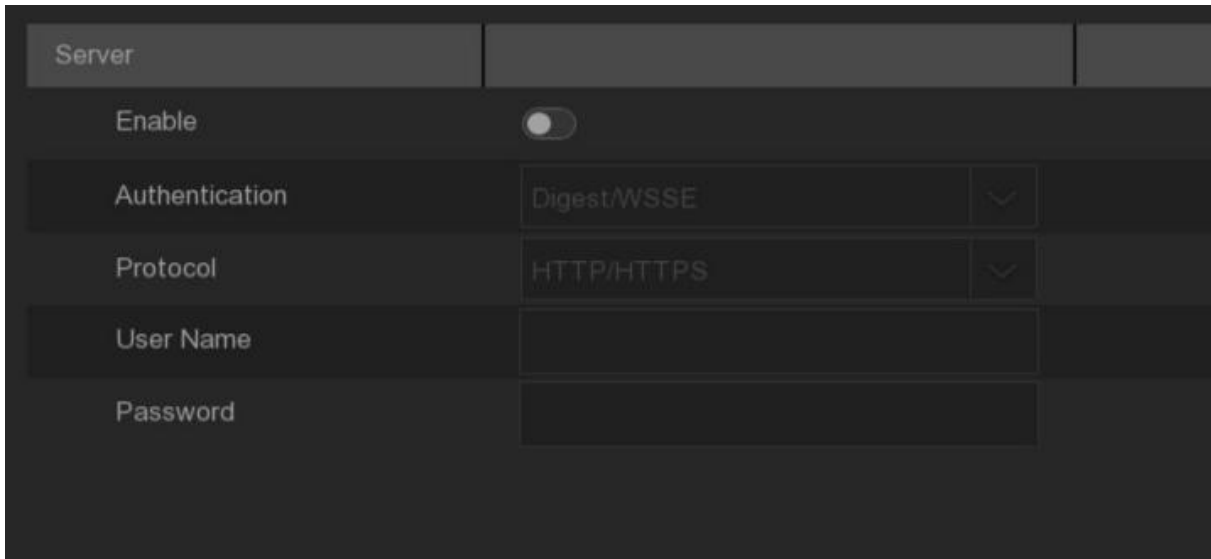

Server	
Enable	<input type="checkbox"/>
Authentication	Digest/WSSE
Protocol	HTTP/HTTPS
User Name	
Password	

Enable: Enabling switch, select the onvif service function of the device after saving

Authentication: Login authentication methods, equipment support authentication methods are Digest_sha256, Digest, Digest / WSSE, WSSE four

Protocol: Connection protocol supported by the equipment includes HTTP / HTTPS, HTTPS and HTTP.

Username: Set up the access user name.

Password: Set up the access password.

5.5.6.2 RTMP

Using RTMP can be NVR channel audio and video stream pushed to YouTube website live in real time, use this function to register YouTube account, and create a studio, the studio site and live code, set to the equipment live server address bar, open and configuration stream type and live channel, save, to YouTube studio refresh page to watch real-time live.

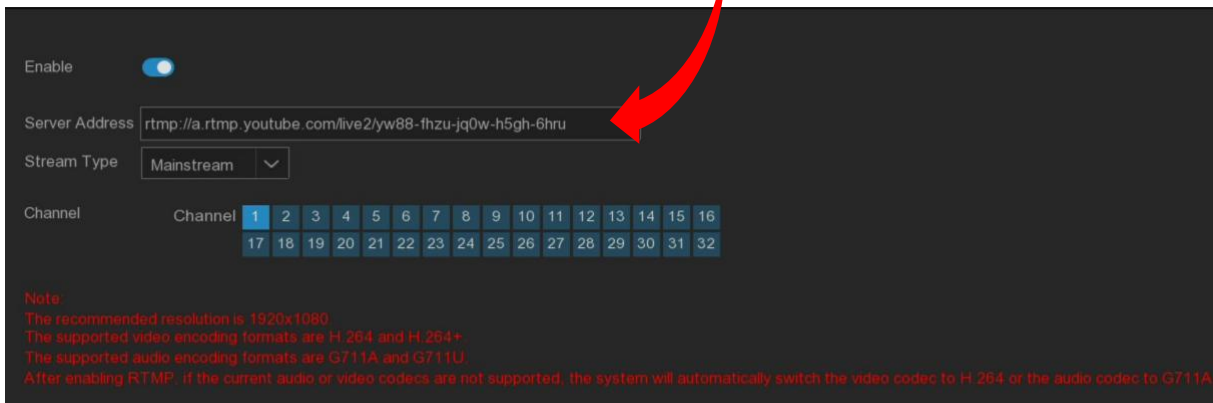
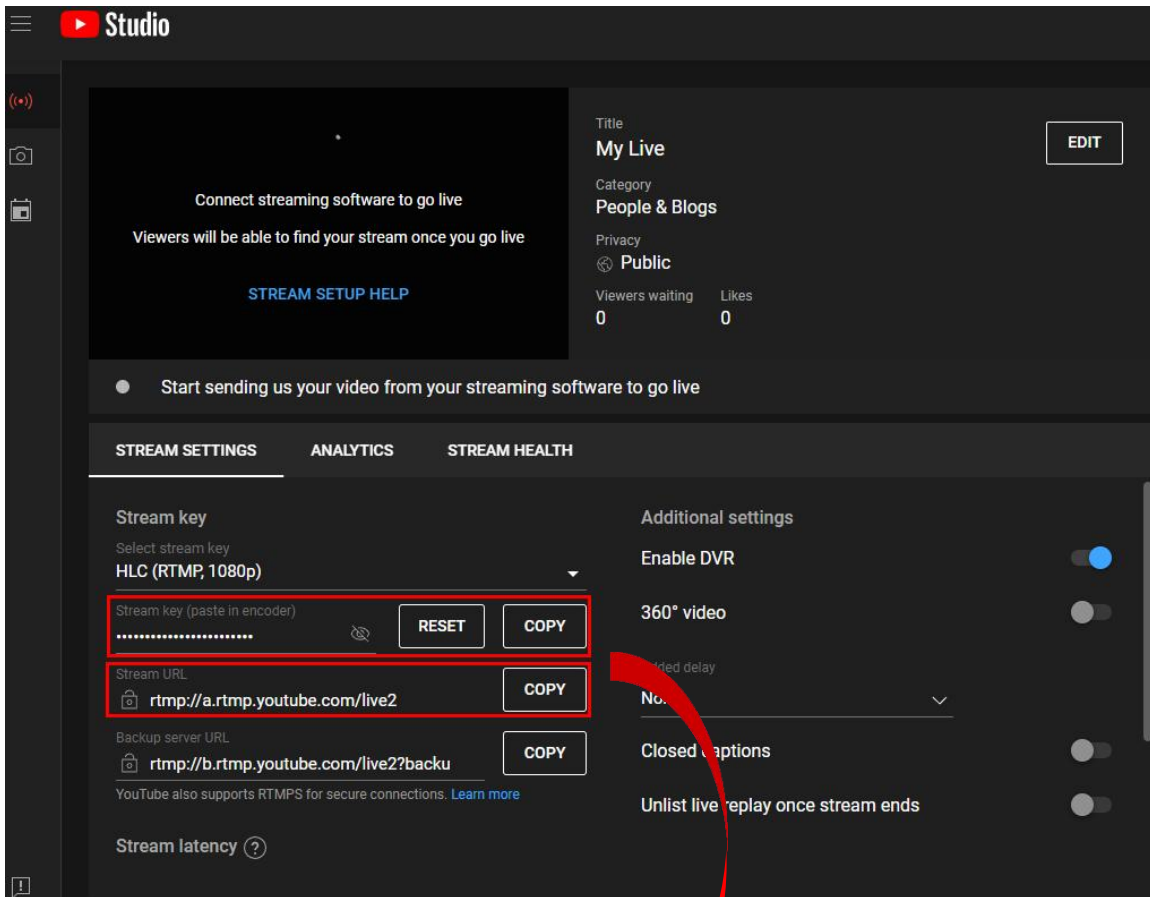

Enable: Enable switch, open and save can enable RTMP live broadcast function.

Server Address: Fill in the live broadcast address and live broadcast code of the YouTube server.(**Note:** "/" is used in the middle of YouTube live broadcast code)

Stream Type: Select the code stream type of the live broadcast channel to support the main stream and the sub stream.

Channel: Select the channel to live broadcast, only one channel.

Note: In order to ensure the effect of the live broadcast, it is recommended that the resolution setting of the code stream should not exceed 1920 * 1080

Only support live broadcast of video coding format H.264 and audio coding format G711A / U data stream.

Youtube live code can only be set for one device, and can not be reused.

5.5.6.3 Event Push Platform

To push the device side alarm information to the designated third party platform (using this function to ensure that the third party platform has completed the docking and debugging with the equipment)

Event push is divided into HTTP push and UDP push: HTTP has POST method and GET method. UDP has three methods: unicast, multicast and broadcast.

- HTTP

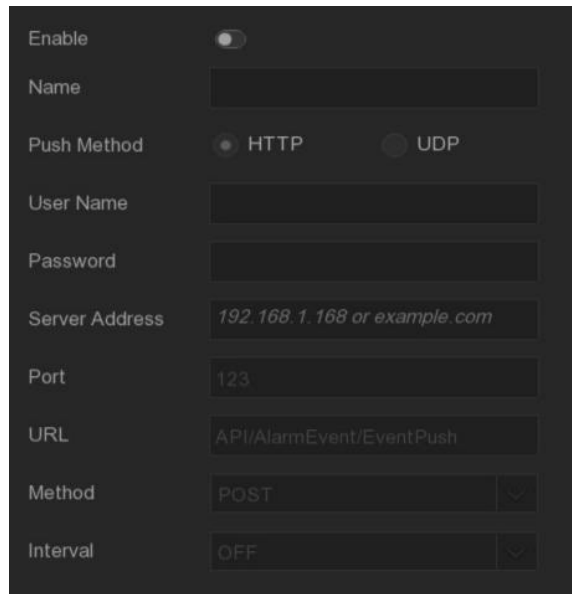

The screenshot shows a configuration panel with the following fields and options:

- Enable:** A toggle switch currently set to 'Off'.
- Name:** An empty text input field.
- Push Method:** Two radio buttons, 'HTTP' (selected) and 'UDP'.
- User Name:** An empty text input field.
- Password:** An empty text input field.
- Server Address:** A text input field containing the placeholder text '192.168.1.168 or example.com'.
- Port:** A text input field containing the value '123'.
- URL:** A text input field containing the value 'API/AlarmEvent/EventPush'.
- Method:** A dropdown menu currently showing 'POST'.
- Interval:** A dropdown menu currently showing 'OFF'.

Enable: Start or turn off the event push function.

Name: Set up the name of the device used to send the alarm information to the third-party platform.

Push Method: Support HTTP push mode and UDP push mode. HTTP is HTTP push mode and UDP is UDP push mode.

User Name: User name of the third-party platform

Password: Third-party platform password.

Server Address: Address of the third-party platform

Port: Third-party platform server port (port range 1-65535).

URL: the third-party platform server API interface.

Method: HTTP push type. POST method and GET method are supported: only HTTP-POST method supports push, other only push message without push. push alarm type is consistent with the web preview warning bar.

Interval: warranty interval, according to the set time, the device will regularly send messages to the server, UDP no warranty mechanism.

- UDP

Enable	<input checked="" type="checkbox"/>
Name	<input type="text"/>
Push Method	<input type="radio"/> HTTP <input checked="" type="radio"/> UDP
UDP Method	<input type="text" value="Broadcast"/> ▾
UDP Address	<input type="text" value="255.255.255.255"/>
UDP Port	<input type="text" value="5000"/>

Enable: Start or turn off the event push function.

Name: Set up the name of the device used to send the alarm information to the third-party platform.

Push Method: Support HTTP push mode and UDP push. HTTP is HTTP, and UDP is UDP.

UDP Method: Support unicast Unicast, multicast Multicast, broadcast Broadcast three methods:

Unicast: Enter the IP address and port of the client UDP server, and only this address can receive the push message.

Multicast: Multiple client UDP servers can receive messages using the same UDP address and port, and other UDP addresses will not receive messages.

Broadcast: All UDP servers in the same network segment can receive messages.

UDP Address: UDP server address.

UDP Port: UDP Server Port (Port range 1-65535)

5.5.6.4 Cloud storage

The device will upload alarm pictures and video clips to the cloud for storage. The Dropbox / Google Drive can provide free storage services to meet the needs of cloud storage.

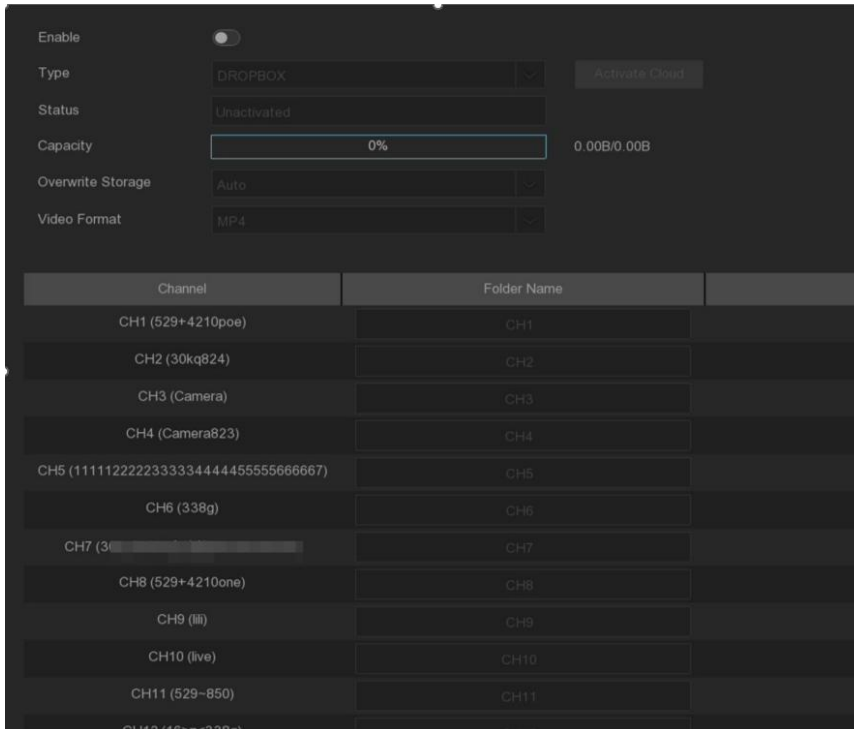

Before you enable cloud storage services, we recommend that you create an Dropbox account with a mailbox user name and password. After the creation, log in to www.dropbox.com, enter the email address and password, and click the login button after agreeing to the terms.

Enable: Check to enable the feature.

Type: Select the cloud storage type, with Dropbox and Google Drive.

Status: Active state of the cloud storage, not activated (Unactivated) and activated (Activated).

Capacity: Display the remaining capacity / total capacity.

Overwrite Storage: Set up the cloud storage overwrite mode.

Video Format: Set the uploaded video format, and support AVF, MP4, AVI format selection.

Folder Name: Set the folder name for storing the channel videos and images

Activate Cloud: Click to activate the cloud storage features. Later, you will see a message on the screen. You have the activation link sent to the email, check the email, and then click the link to activate the cloud storage.

5.5.6.5 FTP

Settings through this menu can meet the requirements of user alarm event FTP storage, and upload grab pictures and videos to the FTP server when the alarm is triggered.

FTP Enable	<input checked="" type="checkbox"/>	
Server IP	<input type="text"/>	Test FTP
Port	<input type="text" value="00021"/>	
User Name	<input type="text"/>	
Password	<input type="text"/>	
Picture Quality	<input type="text" value="Higher"/>	▼
Video Stream Type	<input type="text" value="Substream"/>	▼
Max Package Interval (Min)	<input type="text" value="30 Min"/>	▼
Directory Name	<input type="text"/>	

FTP Enable: Click to enable the FTP functionality.

Server IP: Enter the FTP server IP address or domain name.

Port: Enter the FTP service port

User Name / Password: Enter the user name and password of the FTP server.

Picture Quality: Set the quality of the image uploaded to the FTP.

Video Stream Type: Set the type of video stream uploaded to FTP, with master and substreams optional.

Max Package Interval: Set the maximum video time interval, that is, what is the maximum video time of an event, after which another video file will be created to continue recording.

Directory Name: Enter the directory to save the uploaded files. When NVR starts to upload the files to the FTP server, it will automatically create a new directory under the server to store the files.

Upload Alarm Video: Set the warning type for uploading the video to FTP. After clicking the option, you will enter the warning menu in the corresponding alarm type.

Test FTP: Click to test the FTP settings.

5.6 System Settings

Change system information, such as date, time and region, change password and permissions, etc.

5.6.1 System

5.6.1.1 General

General	Date and Time	Daylight Saving Time	Output Configuration
Device Name	<input type="text"/>		
Device ID	<input type="text" value="000000"/>		
Language	English <input type="button" value="v"/>		
Video Format	NTSC <input type="button" value="v"/>		
Auto Lock	OFF <input type="button" value="v"/>		
Web Session Timeout (min)	<input type="text" value="1440"/>	<input checked="" type="checkbox"/> Including Live View	
<input checked="" type="checkbox"/> Show the Startup Wizard after system startup.			

Device Name: Set the device name

Device ID: Set up the device ID. The device ID is used to identify the NVR, and is only composed of numbers. For example, install 2 NVR in the same location, with one NVR device ID 000000 and another NVR device ID 111111. When operating an NVR with the remote control, both NVRs may receive signals from the controller and act simultaneously. If you only want to control the NVR with ID 111111, you can enter the device ID 111111 in the login page with the remote control for further operation.

Language: Set up the system language of the device

Video Format: Set the video system to PAL or NTSC.

Auto Lock: Set the timeout time to exit the main menu and lock it out when the system is not operating

Web Session Timeout (min): Set the timeout time when the web is idle

Including Live View: The idle login time on the web side is applicable for preview.

Show the Startup Wizard after system startup: If you need to display the boot wizard at each boot time, check this option.

5.6.1.2 Date and time

The screenshot displays the configuration page for date and time. At the top, there are two radio buttons: 'Static' (selected) and 'NTP'. Below this, there are five rows of configuration options:

Date	02/15/2025	
Time	13:44:51	
Date Format	MM/DD/YYYY	▼
Time Format	24Hour	▼
Time Zone	GMT+08:00	▼

Date: Click the calendar to change the date.

Time: Click on the time box to change the time.

Date Format: Set the system date display format.

Time Format: Set the system time display format.

Time Zone: Set up the time zone of the device.

NTP (Network time Service)

Enabling the NTP function will allow NVR to automatically synchronize the time with the time server, and NVR will regularly request updates from the server and correct the time of the NVR system to ensure the accuracy of the device time.

Static NTP

Date: 02/15/2025

Time: 13:45:26

Date Format: MM/DD/YYYY

Time Format: 24Hour

Time Zone: GMT+08:00

Server Address: pool.ntp.org

Update Now

Enable NTP and select a server address or manually enter a server address that supports NTP timing, click [Update Now](#) to manually synchronize the date and time.

Click [Apply](#) to save the settings.

After the NTP function is enabled, the device should be ensured in the network state, and the device will automatically correct the system time at each startup and around 00:07:50 every day.

5.6.1.3 Daylight Saving Time

If the DST daylight time is implemented in the user area, relevant parameters can be set in this interface and DST can be enabled.

Enable DST

Time Offset: 1Hour

DST Mode: Week

Start Time: Mar., The 2nd, SUN, 02:00:00

End Time: Nov., The 1st, SUN, 02:00:00

Enable DST: Daylight saving time switch

Time Offset: Set the daylight saving time offset time duration.

DST Mode: Set the start and end mode of daylight saving time.

Week: Choose the start and end month, specific week and time. For example, at 2 am on the first Sunday of a certain month.

Date: Select the start date (click the calendar  icon), date and time to start and end daylight.

Start Time / End Time: Set the start time and the end time of daylight saving time.

5.6.1.4 Output configuration

Set the system display output parameters.

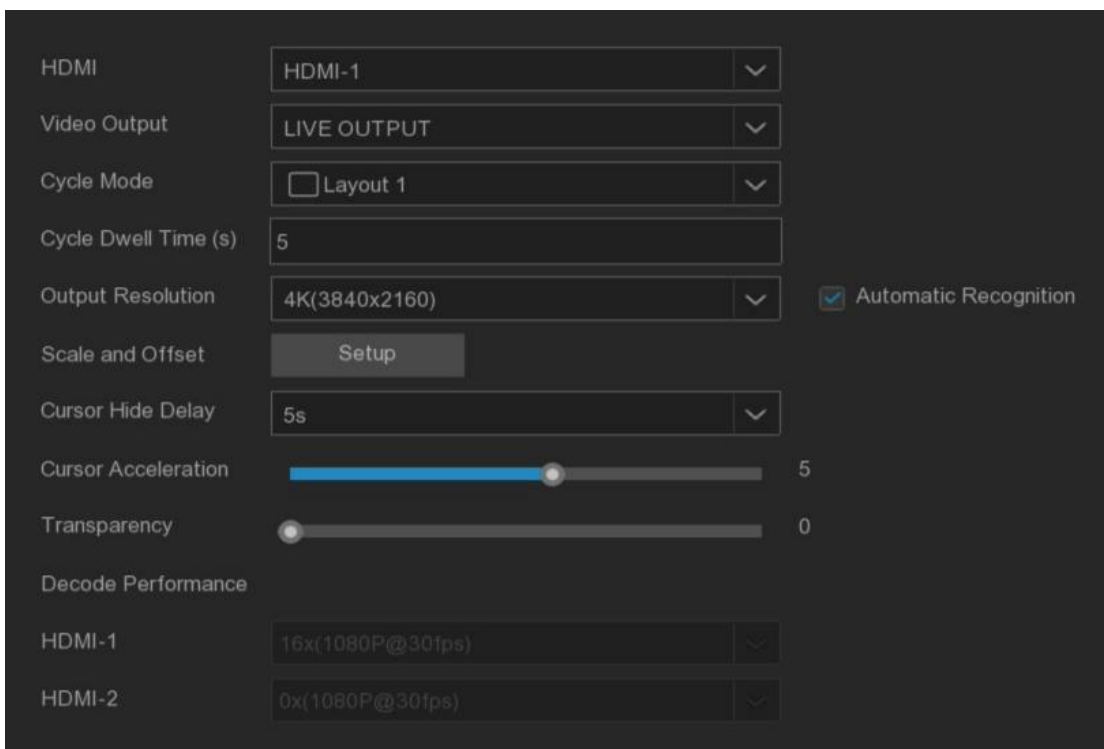

Select the LIVE-OUT mode in the Video Output drop-down menu.

Cycle Mode: Set the number of video channels displayed by NVR in wheel patrol mode.

Cycle Dwell Time: Set the wheel patrol time in seconds.

Output Resolution: Select the display resolution suitable for the display.

Automatic recognition: Automatic identify the resolution of the display, after the startup when the detection of the system when the resolution of the highest resolution supported by the display, and prompt to switch to the appropriate resolution.

Scale & Offset: NVR supports adjusting the size and position of the display to match the display.

Click the Settings button to adjust.

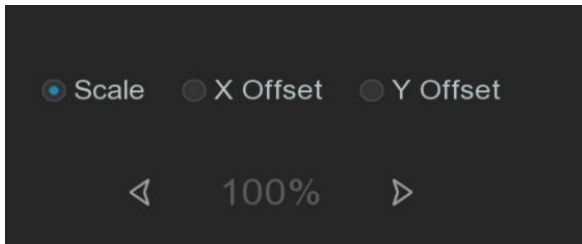

Scale: Scale up the displayed screen size.

X Offset: Move the screen to the left or right.

Y Offset: Move the screen up or down.

You can resize and position by clicking once or pressing the left mouse button on the arrow, or you can scroll the mouse wheel to adjust. Right-click to exit, and click Apply to save the changes.

Cursor Hide Delay: Set the time to hide the mouse cursor when the NVR is idle.

Cursor Acceleration: Adjust the speed of the cursor movement.

Transparency: Click and hold the left or right slider to change the transparency of the menu bar and the main menu on the screen.

● HDMI 2

Set auxiliary screen display output parameters (only some NVR models support)



Switch: Enable or close the auxiliary screen display switch.

Auto Cycle: View Settings, optional static, dynamic two, select dynamic screen will be on the auxiliary screen round preview.

Cycle Mode: Set the number of video channels to be displayed by the device in the HDMI 2-round patrol mode.

Cycle Dwell Time: Set the patrol time on the auxiliary screen wheel in seconds.

Spot Display Channel: Select the channel of the auxiliary screen wheel patrol in dynamic mode.

Output Resolution: Select the display resolution suitable for the auxiliary screen display.

Decode Performance: Set the decoding performance of the auxiliary screen output.





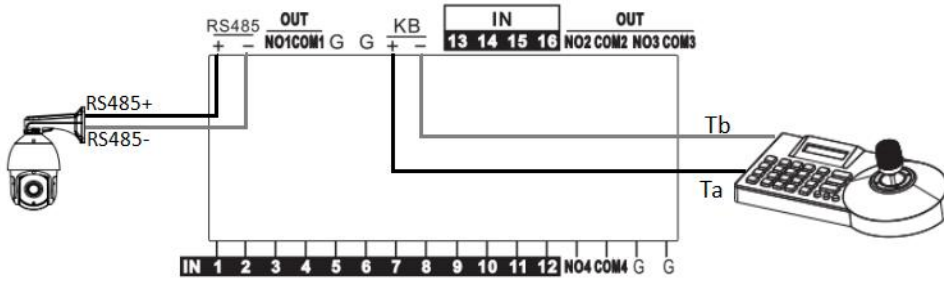



























5.6.1.5 Keyboard settings

To control High-Speed Dome connected to the device using the RS485 via a keyboard.



- Note:** 1. This feature is only suitable for devices with KB interfaces.
 2. To use this function, you should first understand the keyboard parameters, and set the relevant parameters to this page to save successfully.

5.6.2 Multi-user management

No.	User Name	Level	Enable Switch	Edit	Permission
1	admin	ADMIN	Enable		
2	user1	USER	Disable		
3	user2	USER	Disable		
4	user3	USER	Disable		
5	user4	USER	Disable		
6	user5	USER	Disable		
7	user6	USER	Disable		
8	user7	USER	Disable		
9	user8	USER	Disable		
10	user9	USER	Disable		
11	user10	USER	Disable		
12	user11	USER	Disable		
13	user12	USER	Disable		
14	user13	USER	Disable		
15	user14	USER	Disable		
16	user15	USER	Disable		
17	user16	USER	Disable		

Default Login User: 

The system supports the following user types.

- **ADMIN- -System Administrator:** The administrator has the highest permission to configure the system, and can change the administrator's password and user password, and enable / disable password protection.
- **USER- -Ordinary user:** users can only get access to preview, search, playback and other functions. You can set up multiple ordinary user accounts with different access rights.

Default Login User: Default user, that is, the default user of NVR restart to log in.







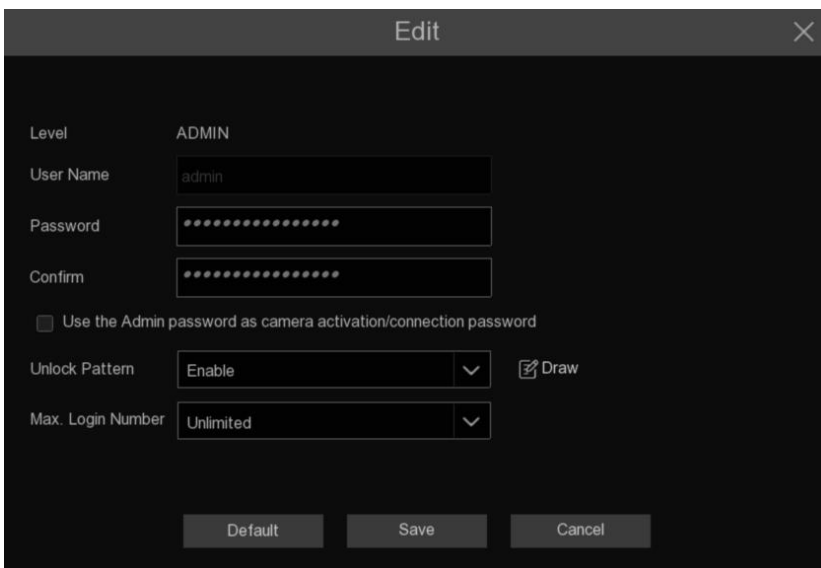





5.6.2.1 Change the password and the single user login number

Need to change the password of the administrator or  ordinary user, click the icon, the password should be set to 8-16 bit characters, the password should not be set to be the same as the user name, including at least two kinds of numbers, capital letters, lower case letters or special characters,

Maximum access users (1-20 supported or unlimited), click [Save](#) to save settings.



5.6.2.2 Add new users

No.	User Name	Level	Enable Switch	Edit	Permission
1	admin	ADMIN	Enable		
2	user1	USER	Disable		
3	user2	USER	Disable		
4	user3	USER	Disable		
5	user4	USER	Disable		
6	user5	USER	Disable		
7	user6	USER	Disable		

1. Select one of the users currently inactive, and click  user edit icon.

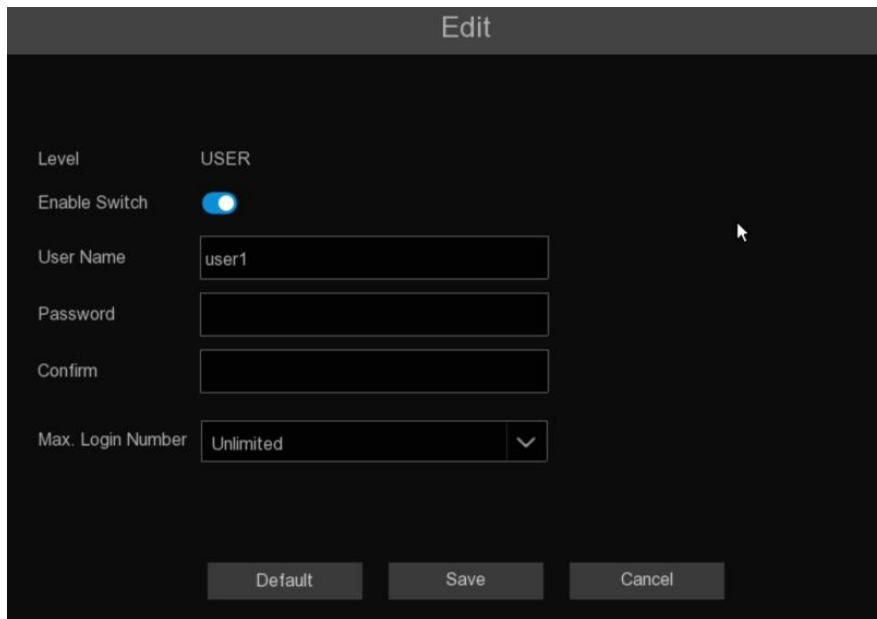

Level USER

Enable Switch

User Name user1

Password

Confirm

Max. Login Number Unlimited

Default Save Cancel

2. Open "Enable Switch" to enable the user.
3. Click User Name to edit the user name.
4. Click on the Password area to enter the desired password.
5. Click on the Confirm area to re-enter the password.
6. Click Max.Login Number to set the maximum number of access users allowed by the device.

5.6.2.3 Set the user permission

The Administrator account is the only account that has all control of the system, and this page can enable or disable certain menus and functions for each regular user.

1. Click the Edit icon under the  Permissions tab

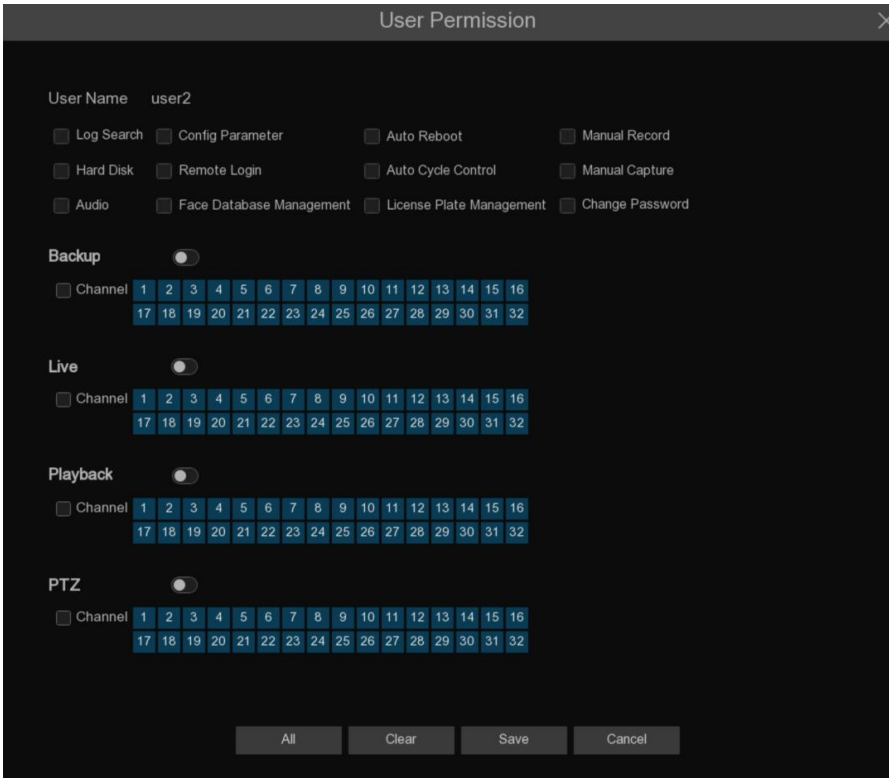

The screenshot shows the 'User Permission' configuration window for 'user2'. It includes a list of permissions with checkboxes, and four sections (Backup, Live, Playback, PTZ) each with a toggle switch and a grid of 32 channel selection boxes. At the bottom are 'All', 'Clear', 'Save', and 'Cancel' buttons.

2. Set the user's permission and check the box corresponding to the function. Click All to select all of the boxes. Click Clear to clear all of the boxes.

User password permission setting, the administrator can select the permission of ordinary users as required.

Have the following privileges to select.

- **Log search:** you can view the device's log.
- **Parameter setting:** you can set the parameters of all the pages.
- **Automatic restart:** automatic maintenance and restart of operable equipment.

- **Manual recording:** Manually start video recording and can manually stop video recording.
- **Hard disk management:** Operate and set the hard disk.
- **Remote login:** Users have remote access to NVR.
- **Polling control:** Rotation to view the real-time preview of all channels.
- **Manual capture:** Manual start capturing.
- **Audio:** Control the channel audio control and intercom.
- **Face database management:** whether you can operate the face database.
- **License plate database management:** whether the license plate database can operate the license plate database.
- **Subuser change password:** whether the sub user login can modify the subuser password.
- **Backup:** After opening the Backup channel to enable the switch and select the backup channel, the average user has permission to back up the video of the selected channel.
- **Preview:** Open the Preview enable switch and select a channel for preview viewing, and the average user has the permission to monitor the real-time preview of the selected channel.
- **Video playback:** After opening the "video playback" enabled switch and select the channel to view, the average user has the permission to replay the selected channel video.
- **PTZ:** open the "PTZ" enabling switch and select the operational channel, the average user has the PTZ operation permission.

3. Click **Save** button to save the modifications.

5.6.3 Maintenance

5.6.3.1 Log

The system log records the relevant system event information, such as various types of alarms and system operation records.

The screenshot displays the 'Log' management interface. At the top, there are navigation tabs: 'Log', 'Load Default', 'Upgrade', 'Parameter Management', 'Auto Maintenance', and 'Developer Mode'. Below these are search filters: 'Start Date' (02/15/2025), 'Start Time' (00:00:00), 'End Date' (02/15/2025), 'End Time' (23:59:59), and 'Log Type' (All). A 'Search' button is located to the right of the filters. The main area contains a table with the following columns: Channel, Type, Time, Content, Access Source, Record, and Playback. The table lists several 'Motion alarm started' and 'Motion alarm ended' events for channel CH23, along with one 'System' event for NTP. At the bottom, there is a 'Total : 11537' indicator, a pagination control showing '1 / 385', and a 'Backup' button.

Channel	Type	Time	Content	Access Source	Record	Playback
CH23	Alarm	02/15/2025 00:00:10	Motion alarm started		Yes	
CH23	Alarm	02/15/2025 00:00:37	Motion alarm ended		Yes	
CH23	Alarm	02/15/2025 00:01:17	Motion alarm started		Yes	
CH23	Alarm	02/15/2025 00:01:44	Motion alarm ended		Yes	
CH23	Alarm	02/15/2025 00:02:23	Motion alarm started		Yes	
CH23	Alarm	02/15/2025 00:02:50	Motion alarm ended		Yes	
CH23	Alarm	02/15/2025 00:03:30	Motion alarm started		Yes	
CH23	Alarm	02/15/2025 00:03:57	Motion alarm ended		Yes	
CH23	Alarm	02/15/2025 00:04:36	Motion alarm started		Yes	
CH23	Alarm	02/15/2025 00:05:03	Motion alarm ended		Yes	
	System	02/15/2025 00:07:50	NTP	Local		
CH23	Alarm	02/15/2025 00:08:13	Motion alarm started		Yes	
CH23	Alarm	02/15/2025 00:08:57	Motion alarm ended		Yes	

Log Search and Backup:

1. Click the area next to Start Date and Start Time to select the start date and time of the search from the screen calendar.
2. Click the area next to End Date and End Time to select the end date and time of the search from the screen calendar.
3. Select the type of event you want to search from the drop-down list next to the Log Type, or select All to view the entire system log for the selected time period.

System: Record the log information of system setting, restart, automatic restart, upgrade, time setting and NTP timing.

Configuration: Record preview control, privacy area setting, recording mode setting, recording schedule settings, main code flow settings, network settings, subcode Settings, mail settings, color setting, motion detection settings, hard drive settings, multiple users, NTP settings, image control, the third stream settings, RTSP settings, IP filter Settings, system recovery Settings from the factory Settings, audio Settings, video Tampering alarm Settings, export Settings and import Settings operation logs.

Alarm: Record the alarm information.

Account: Record the login and login records of local or external visitors.

Record: Record the operation log of search, playback and backup.

Storage: Record log information such format hard disk, hard disk full and hard disk errors.

AI: Record the alarm information of intelligent events.

4. Click Search to Search.
5. Browse through the system log from the selected time period:
 - Events can be played immediately by clicking Playback.
 - Switch between the pages < K > > of the system log events using the / button in the lower right corner of the menu.
6. Click **Backup** to create a backup of the system log. Ensure that the external storage device is connected to the USB port of the NVR.
7. The Backup drive menu appears. Navigate to the folder where you want to save the backup file, and then click OK to Start.

5.6.3.2 Restore factory settings

This page supports various ways to restore the NVR parameters to the factory settings. Once the data is cleared, it cannot be restored. Please choose carefully.

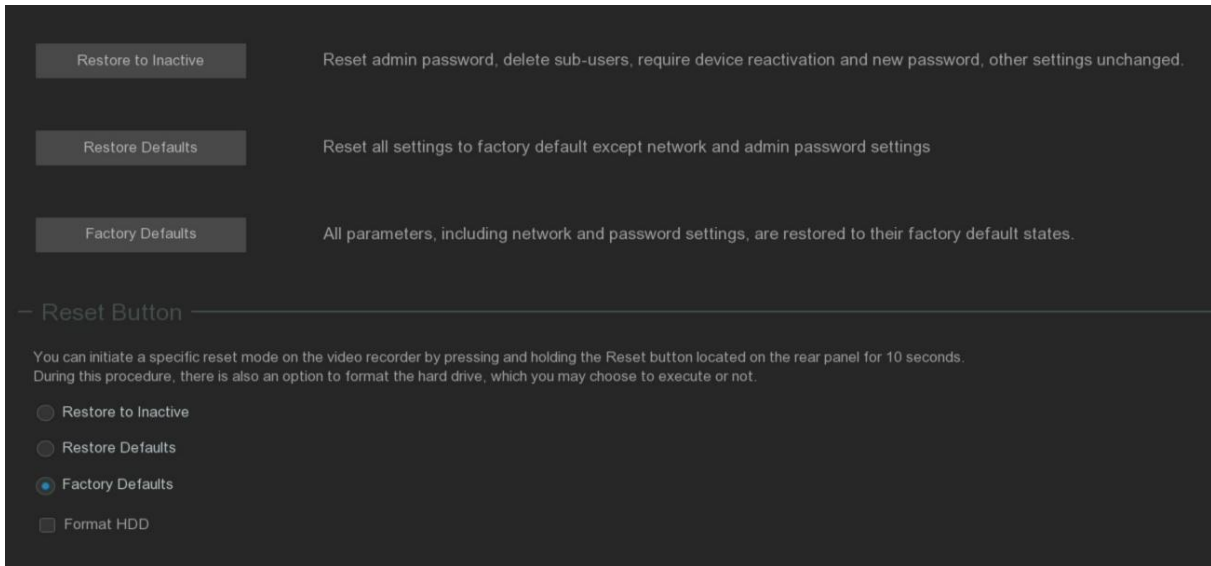

Restore to Inactive: Reset the administrator password, delete all sub-users, the device needs to be reactivated, and other page parameter settings remain unchanged.

Restore Defaults: Except for the basic network parameters and administrator password, all the parameters of other pages are restored to factory Settings.

Factory Defaults: All the parameters are restored to the factory settings.

In addition, the device supports press the RESET button on the rear panel for 10 seconds to perform the corresponding recovery mode. Check **Format HDD** to format the hard disk at the same time. Once the data will not be recovered. Please choose carefully.

5.6.3.3 Upgrade

5.6.3.3.1 Udisk Upgrade

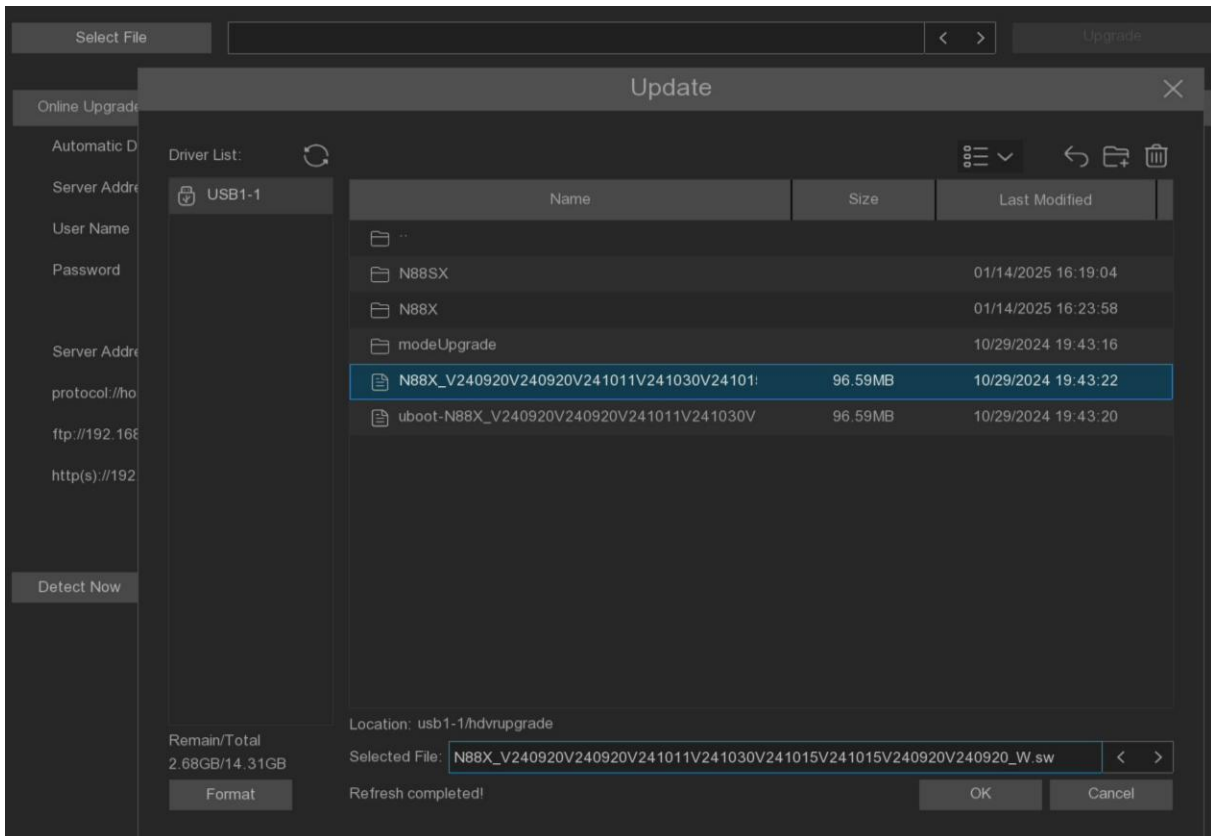

1. To send the firmware file (.bin file) copy to the USB drive and then insert the U disk into the USB port of the NVR.
2. Click Select File to select the firmware file in the USB Flash drive, and then click OK.
3. Click the upgrade button to start the system upgrade. The system upgrade will last about 5-10 minutes. Do not power off the NVR or remove the U disk from the NVR during the firmware upgrade.

5.6.3.3.2 Online upgrade

The device supports the online upgrade function. If this function is used, you should set up the upgrade server in advance, and create a file storage directory on the server, and upload the upgrade firmware to complete.

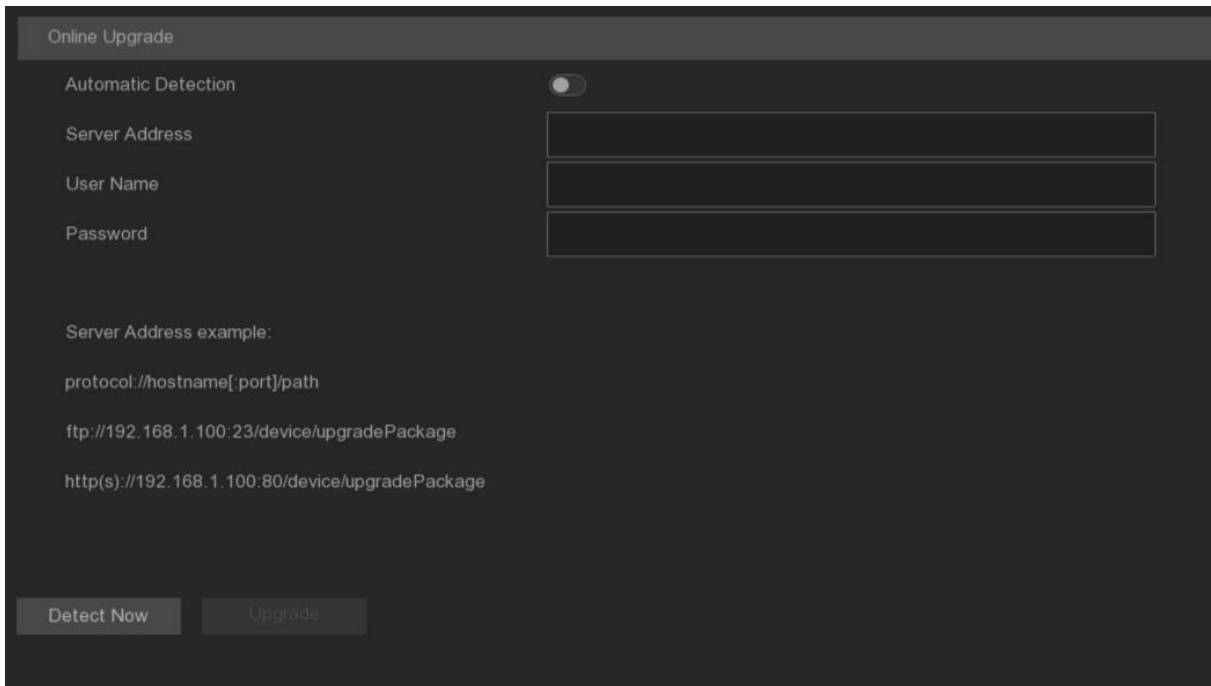

The screenshot shows the 'Online Upgrade' configuration page. At the top, there is a toggle switch for 'Automatic Detection'. Below it are three input fields: 'Server Address', 'User Name', and 'Password'. Underneath these fields, there is a section for 'Server Address example:' which provides two examples: 'protocol://hostname[:port]/path' and 'ftp://192.168.1.100:23/device/upgradePackage' and 'http(s)://192.168.1.100:80/device/upgradePackage'. At the bottom of the form, there are two buttons: 'Detect Now' and 'Upgrade'.

Username: Set the server user name, if the server does not set the user, here can be empty

Password: Set the server password, if the server does not set the password, here can be empty.

Server Address: Set the server address, and the upgrade address should be specified to the storage directory of the upgrade file.

Automatic Detection: Automatic detection. After enabling, the device will check and upgrade the firmware from the server regularly during startup and during operation. If there is an updated firmware, a popup will be prompted.

Detect Now: Click the button to manually check the server for upgradable firmware.

Upgrade: When the server detects renewable firmware, this button will be highlighted and click OK to allow the device to upgrade.

Note: If the device needs to detect the latest firmware version of the cloud server, please open the cloud service switch to bind the CybVu APP and clear the configuration parameters for the online upgrade on this page.

5.6.3.4 Parameter management

Users can export the currently configured parameter file to the U disk, or import the exported parameter profile from the U disk into the same model device.

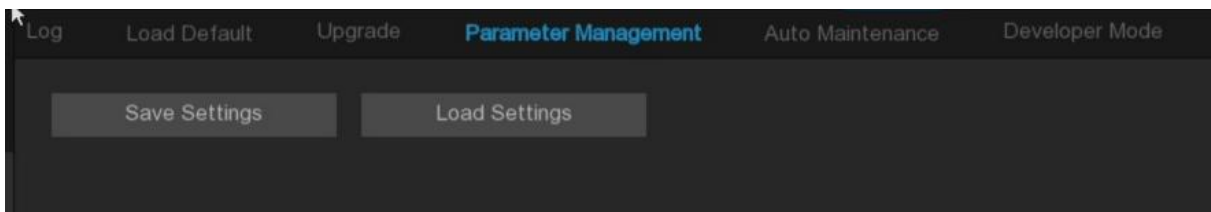

Save Settings: Save the current device system configuration parameters to the specified USB storage directory.

Load Settings: Import the configuration parameters in the USB storage directory into the current device, and the device will automatically restart after the import completes.

5.6.3.5 Automatic maintenance

This menu allows the system to restart regularly, and it is recommended to keep this function enabled.

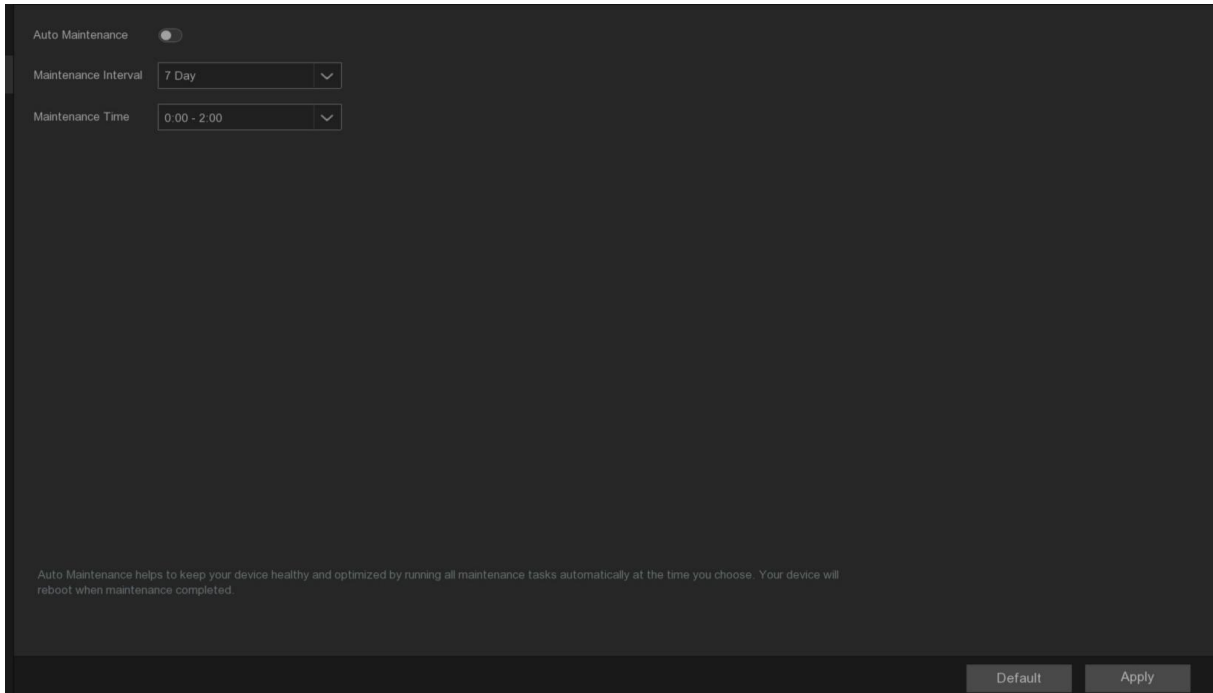

Auto Maintenance: Enable or close the automatic maintenance function.

Maintenance Interval: Set the automatic maintenance cycle of the equipment.

Maintenance Time: Set the equipment automatic maintenance period. (**Note:** Device will restart at random time during this period)

5.6.3.6 Developer Mode

When the system has an exception, developers can collect the serial port log information when the system runs through this page to locate the problem.

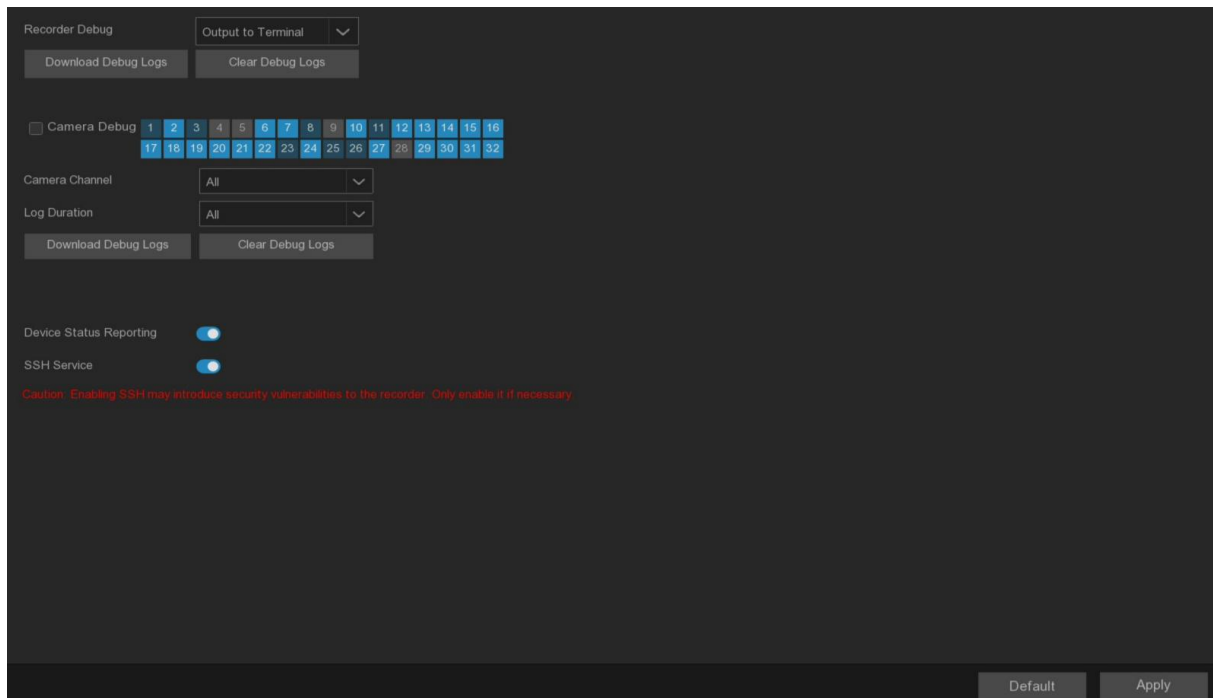

Recorder Debug: Set whether the video recorder enables the debug mode and the output position of the debug log.

Disabled: Do not save the serial port log.

Output To Terminal: Export the serial port log to the terminal.

Output To Hard Disk: Save the serial port log to the hard disk.

Download Debug Logs: Export the serial port log to the U disk.

Clear Debug Logs: Delete the collected serial port log in the hard disk.

Camera Debug: Set whether to record the serial port log of the camera to the video recorder.

After selecting and saving the channel, the camera debugging log of the corresponding channel will be transmitted to the video recorder side for preservation.

Camera Channel: Select the camera channel from which to export the debug log.

Log Duration: Select the period in which to export the debug log.

Download Debug Logs: Export the camera debugging log to U disk and support saving according to the channel and recording time.

Clear Debug Logs: Delete the stored camera debugging log in the hard disk.

Device Status Reporting: Enable this function to upload the storage status, channel status and device information of the device to the P2P server.

SSH Service: When enabled, the device can be accessed using the SSH mode.

5.6.4 IP Camera Maintain

5.6.4.1 IP Camera Upgrade

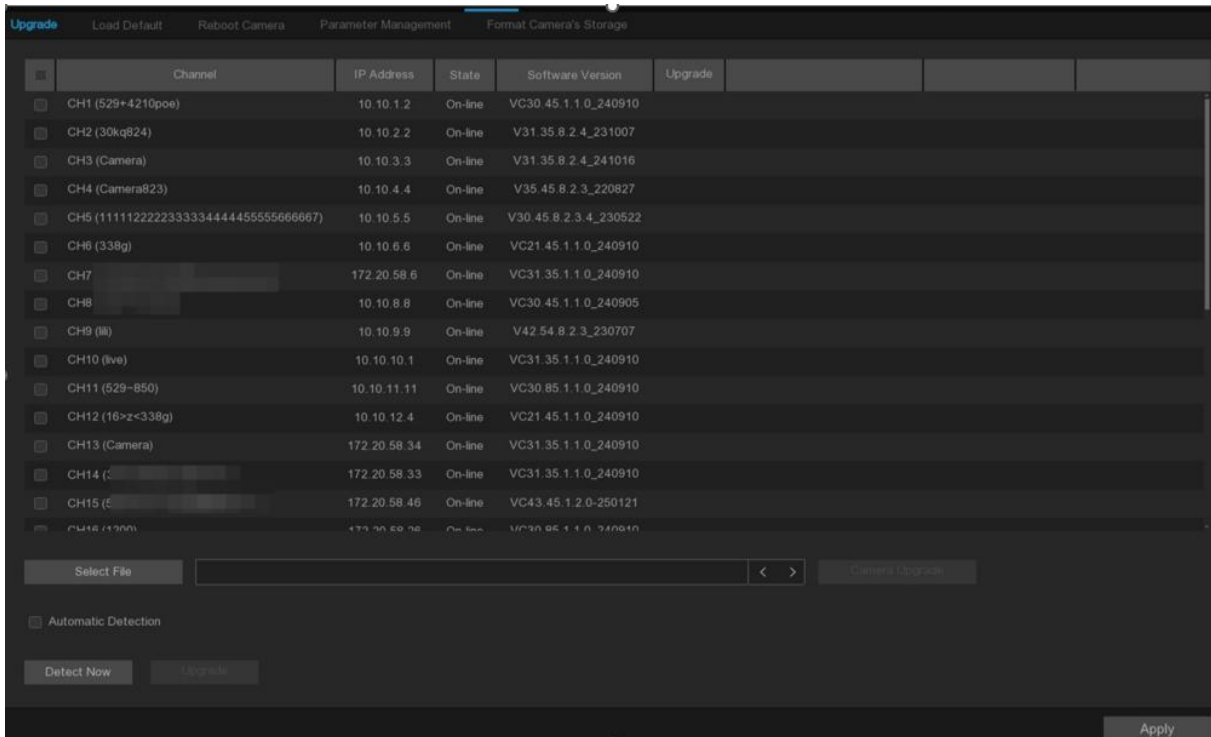

1. Select the IP camera to upgrade.
2. Click [Select File](#), select the upgrade file from the USB storage device, and then click OK.
3. Click the camera [Upgrade](#) button to start the upgrade. Do not power off or unplug the U disk for the NVR and IP cameras during the upgrade.

Automatic Detection: Automatic detection. After enabling, the device runs for 24 hours, and it will detect the latest upgrade file in the server. If so, it will indicate whether to upgrade.

Detect Now: Manually detect the latest upgrade file.

Upgrade: If the latest upgrade file is detected, please click to upgrade.

5.6.4.2 Load Default

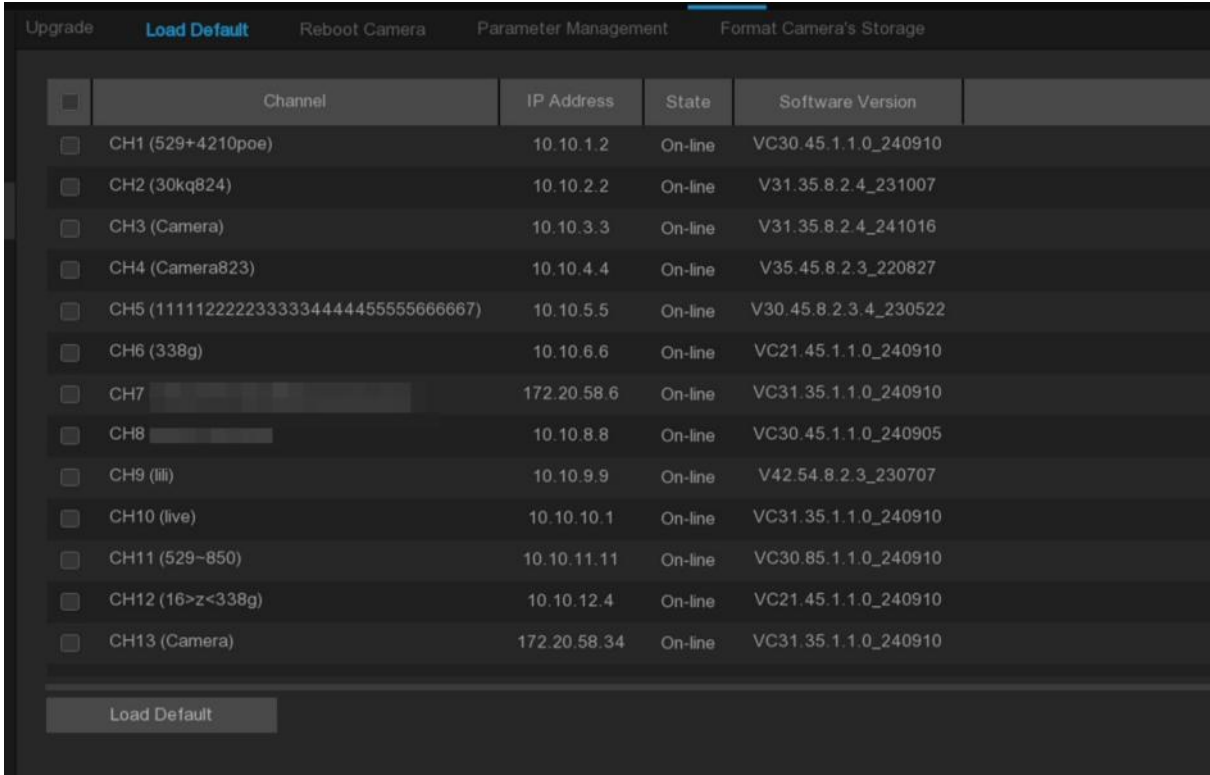

Channel	IP Address	State	Software Version
CH1 (529+4210poe)	10.10.1.2	On-line	VC30.45.1.1.0_240910
CH2 (30kq824)	10.10.2.2	On-line	V31.35.8.2.4_231007
CH3 (Camera)	10.10.3.3	On-line	V31.35.8.2.4_241016
CH4 (Camera823)	10.10.4.4	On-line	V35.45.8.2.3_220827
CH5 (1111122222333334444455555666667)	10.10.5.5	On-line	V30.45.8.2.3.4_230522
CH6 (338g)	10.10.6.6	On-line	VC21.45.1.1.0_240910
CH7	172.20.58.6	On-line	VC31.35.1.1.0_240910
CH8	10.10.8.8	On-line	VC30.45.1.1.0_240905
CH9 (Ili)	10.10.9.9	On-line	V42.54.8.2.3_230707
CH10 (Iive)	10.10.10.1	On-line	VC31.35.1.1.0_240910
CH11 (529~850)	10.10.11.11	On-line	VC30.85.1.1.0_240910
CH12 (16>z<338g)	10.10.12.4	On-line	VC21.45.1.1.0_240910
CH13 (Camera)	172.20.58.34	On-line	VC31.35.1.1.0_240910

Load Default

1. Select the IP camera where you want to restore the factory settings.
2. Click [Load Default](#) to restore the factory settings, you need to enter the administrator password for authentication.

5.6.4.3 Reboot Camera

<input type="checkbox"/>	Channel	IP Address	State	Software Version
<input type="checkbox"/>	CH1 (529+4210poe)	10.10.1.2	On-line	VC30.45.1.1.0_240910
<input type="checkbox"/>	CH2 (30kq824)	10.10.2.2	On-line	V31.35.8.2.4_231007
<input type="checkbox"/>	CH3 (Camera)	10.10.3.3	On-line	V31.35.8.2.4_241016
<input type="checkbox"/>	CH4 (Camera823)	10.10.4.4	On-line	V35.45.8.2.3_220827
<input type="checkbox"/>	CH5 (1111122222333334444455555666667)	10.10.5.5	On-line	V30.45.8.2.3.4_230522
<input type="checkbox"/>	CH6 (338g)	10.10.6.6	On-line	VC21.45.1.1.0_240910
<input type="checkbox"/>	CH7	172.20.58.6	On-line	VC31.35.1.1.0_240910
<input type="checkbox"/>	CH8	10.10.8.8	On-line	VC30.45.1.1.0_240905
<input type="checkbox"/>	CH9 (liii)	10.10.9.9	On-line	V42.54.8.2.3_230707
<input type="checkbox"/>	CH10 (live)	10.10.10.1	On-line	VC31.35.1.1.0_240910
<input type="checkbox"/>	CH11 (529~850)	10.10.11.11	On-line	VC30.85.1.1.0_240910
<input type="checkbox"/>	CH12 (16>z<338g)	10.10.12.4	On-line	VC21.45.1.1.0_240910
<input type="checkbox"/>	CH13 (Camera)	172.20.58.34	On-line	VC31.35.1.1.0_240910

Click the IP camera and click [Reboot Camera](#) to restart IP camera.

5.6.4.4 Parameter Management

<input type="checkbox"/>	Channel	IP Address	State	Software Version
<input type="checkbox"/>	CH1 (529+4210poe)	10.10.1.2	On-line	VC30.45.1.1.0_240910
<input type="checkbox"/>	CH2 (30kq824)	10.10.2.2	On-line	V31.35.8.2.4_231007
<input type="checkbox"/>	CH3 (Camera)	10.10.3.3	On-line	V31.35.8.2.4_241016
<input type="checkbox"/>	CH4 (Camera823)	10.10.4.4	On-line	V35.45.8.2.3_220827
<input type="checkbox"/>	CH5 (11111222223333334444455555666667)	10.10.5.5	On-line	V30.45.8.2.3.4_230522
<input type="checkbox"/>	CH6 (338g)	10.10.6.6	On-line	VC21.45.1.1.0_240910
<input type="checkbox"/>	CH7 ()	172.20.58.6	On-line	VC31.35.1.1.0_240910
<input type="checkbox"/>	CH8 ()	10.10.8.8	On-line	VC30.45.1.1.0_240905
<input type="checkbox"/>	CH9 (lili)	10.10.9.9	On-line	V42.54.8.2.3_230707
<input type="checkbox"/>	CH10 (live)	10.10.10.1	On-line	VC31.35.1.1.0_240910
<input type="checkbox"/>	CH11 (529-850)	10.10.11.11	On-line	VC30.85.1.1.0_240910
<input type="checkbox"/>	CH12 (16>z<338g)	10.10.12.4	On-line	VC21.45.1.1.0_240910
<input type="checkbox"/>	CH13 (Camera)	172.20.58.34	On-line	VC31.35.1.1.0_240910

Save Settings Load Settings

After checking the IP camera, click [Save Settings](#) to save the IP camera parameters to the U disk.

After selecting the IP camera, select the saved parameter file, click [Load Settings](#) can import the IP camera parameters. Note: The parameter file must be imported into IP camera of the same model.

5.6.4.5 Format Camera's Storage

<input type="checkbox"/>	Channel	IP Address	Serial No.	Type	State	Free/Total	Free Time
<input type="checkbox"/>	CH7 (3)	172.20.58.6	SD Card	Read and Write	FULL	0M/14G	0s/10Hour
<input type="checkbox"/>	CH11 ()	10.10.11.11	SD Card	Read and Write	FULL	0M/14G	0s/4Hour
<input type="checkbox"/>	CH15 ()	172.20.58.46	SD Card	Read and Write	FULL	0M/29G	0s/33Hour
<input type="checkbox"/>	CH20 ()	172.20.58.44	SD Card	Read and Write	Unformatted	0M/14G	0s/4Hour
<input type="checkbox"/>	CH21 ()	172.20.58.44	SD Card	Read and Write	Unformatted	0M/14G	0s/4Hour
<input type="checkbox"/>	CH29 ()	172.20.58.40	SD Card	Read and Write	HDD ERROR	0M/14G	0s/11Hour
<input type="checkbox"/>	CH30 ()	172.20.58.22	SD Card	Read and Write	FULL	0M/14G	0s/5Hour
<input type="checkbox"/>	CH32 ()	172.20.58.41	SD Card	Read and Write	FULL	0M/29G	0s/33Hour

The system can detect the IP camera already connected to the SD card. Click [Format](#) button to format the SD card of the IP camera.

5.6.5 Information

5.6.5.1 System information

View the device ID, device model, IP address, MAC address, firmware version, etc.

Information Channel Information Record Info Network State Privacy Statement

Device ID	000000
Device Name	[Redacted]
Device Type	[Redacted]
Hardware Version	2M032
Software Version	VC1.2.0-250121
IE Client Version	VC1.2.0.15-250121
Video Format	NTSC
Total HDD Capacity	7452G
IP Address	172.20.58.38
IPv6 Address	fe80::3a24:f11f:fe06:4fc1 / 64
Http	80,80
MAC Address	38-24-F1-06-4F-C1
Network State	Connected
P2P ID	[Redacted]
Cloud ID	[Redacted]

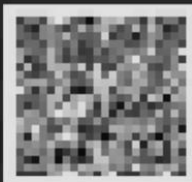

5.6.5.2 Channel information

Channel	State	Mainstream	Substream	Thirdstream
CH1 (529+4210poe)	On-line	2560x1440, 30Fps, 3Mbps	320x240, 30Fps, 512Kbps	640x480, 30Fps, 512Kbps
CH2 (30kq824)	On-line	1280x960, 30Fps, 2Mbps	1280x720, 30Fps, 1024Kbps	640x480, 30Fps, 512Kbps
CH3 (Camera)	On-line	1920x1080, 30Fps, 2Mbps	640x480, 30Fps, 1024Kbps	N/A
CH4 (Camera823)	On-line	2560x1440, 30Fps, 8Mbps	640x480, 30Fps, 512Kbps	640x480, 30Fps, 512Kbps
CH5 (111112222333334444455555666667)	On-line	2560x1440, 30Fps, 8Mbps	1280x720, 30Fps, 1024Kbps	640x480, 30Fps, 512Kbps
CH6 (338g)	On-line	1280x960, 25Fps, 2Mbps	1280x720, 20Fps, 768Kbps	640x480, 25Fps, 512Kbps
CH7 (3[Redacted])	On-line	2880x1620, 30Fps, 3Mbps	640x480, 30Fps, 320Kbps	640x480, 30Fps, 512Kbps
CH8 (5[Redacted])	On-line	2560x1440, 15Fps, 2Mbps	640x480, 25Fps, 320Kbps	640x480, 25Fps, 512Kbps
CH9 (88)	On-line	2688x1520, 25Fps, 4Mbps	1920x1080, 25Fps, 2Mbps	640x480, 25Fps, 1024Kbps
CH10 (live)	On-line	1280x960, 30Fps, 2Mbps	1280x720, 25Fps, 1024Kbps	640x480, 25Fps, 512Kbps
CH11 (529-850)	On-line	3840x2160, 25Fps, 8Mbps	1280x720, 23Fps, 1024Kbps	640x480, 25Fps, 512Kbps
CH12 (16>z<338g)	On-line	1280x960, 30Fps, 2Mbps	1280x720, 30Fps, 1024Kbps	640x480, 30Fps, 512Kbps
CH13 (Camera)	On-line	1280x960, 25Fps, 2Mbps	640x480, 25Fps, 320Kbps	640x480, 25Fps, 512Kbps
CH14 (3[Redacted])	On-line	2880x1620, 15Fps, 4Mbps	1280x720, 25Fps, 1024Kbps	640x480, 25Fps, 512Kbps
CH15 (5)	On-line	1920x1080, 26Fps, 2Mbps	1280x720, 30Fps, 1024Kbps	640x480, 30Fps, 512Kbps
CH16 (1200)	On-line	4512x2512, 15Fps, 3Mbps	1920x1080, 15Fps, 1024Kbps	640x480, 15Fps, 512Kbps
CH17 (529+11)	On-line	3840x2160, 25Fps, 8Mbps	640x480, 25Fps, 320Kbps	640x480, 25Fps, 512Kbps

View channel information for each connected camera, such as alias, primary, child, and third stream recording parameters.

5.6.5.3 Record information

Channel	Record State	Record Switch	Stream Type	Resolution	Frame Rate	Bitrate
CH1 (529+4210poe)	ON	Enable	Dual Stream	2560x1440 320x240	30fps 30fps	3Mbps 512Kbps
CH2 (30kq824)	ON	Enable	Dual Stream	1280x960 1280x720	30fps 30fps	2Mbps 1024Kbps
CH3 (Camera)	ON	Enable	Dual Stream	1920x1080 640x480	30fps 30fps	2Mbps 1024Kbps
CH4 (Camera823)	ON	Enable	Dual Stream	2560x1440 640x480	30fps 30fps	8Mbps 512Kbps
CH5 (1111122222333334444455555666667)	ON	Enable	Dual Stream	2560x1440 1280x720	30fps 30fps	8Mbps 1024Kbps
CH6 (338g)	ON	Enable	Dual Stream	1280x960 1280x720	25fps 20fps	2Mbps 768Kbps
CH7 ()	ON	Enable	Dual Stream	2880x1620 640x480	30fps 30fps	3Mbps 320Kbps
CH8 ()	ON	Enable	Dual Stream	2560x1440 640x480	15fps 25fps	2Mbps 320Kbps
CH9 (lll)	ON	Enable	Dual Stream	2688x1520 1920x1080	25fps 25fps	4Mbps 2Mbps
CH10 (live)	ON	Enable	Dual Stream	1280x960 1280x720	30fps 25fps	2Mbps 1024Kbps
CH11 (529-850)	ON	Enable	Dual Stream	3840x2160 1280x720	25fps 23fps	8Mbps 1024Kbps
CH12 (16-z<338g)	ON	Enable	Dual Stream	1280x960 1280x720	30fps 30fps	2Mbps 1024Kbps
CH13 (Camera)	ON	Enable	Dual Stream	1280x960 640x480	25fps 25fps	2Mbps 320Kbps
CH14 ()	ON	Enable	Dual Stream	2880x1620 1280x720	15fps 25fps	4Mbps 1024Kbps
CH15 ()	ON	Enable	Dual Stream	1920x1080 1280x720	26fps 30fps	2Mbps 1024Kbps
CH16 (1200)	ON	Enable	Dual Stream	4512x2512 1920x1080	15fps 15fps	3Mbps 1024Kbps
CH17 (529+11)	ON	Enable	Dual Stream	3840x2160 640x480	25fps 25fps	8Mbps 320Kbps
CH18 (338g)	ON	Enable	Dual Stream	1280x960 640x480	15fps 25fps	1024Kbps 320Kbps

View the recording information for each connected IP camera, such as the bit rate, code stream type, recording resolution, and frame rate (FPS).

5.6.5.4 Network state

Item	Value
LAN 1	
IPv4 DHCP	Enable
IP Address	172.20.58.38
Subnet Mask	255.255.255.0
Gateway	172.20.58.1
IPv6 DHCP	Enable
IPv6 Address	fe80::3a24:11ff:fe06:41c1 / 64
IPv6 Default Gateway	fe80::/64
MAC Address	38-24-F1-06-4F-C1
LAN 2	
IPv4 DHCP	Enable
IP Address	169.254.215.164
Subnet Mask	255.255.255.0
Gateway	172.20.58.1
IPv6 DHCP	Enable
IPv6 Address	fe80::3a24:11ff:fe06:50fc / 64
IPv6 Default Gateway	fe80::/64
MAC Address	38-24-F1-06-50-FC

View the system network information.

Total Bandwidth: Reflects the total input bandwidth of the NVR used for the IP camera.

Used Bandwidth: Reflects the bandwidth used by the IP camera.

5.6.5.5 Privacy Statement

Users can view the specific content of the device's privacy statement on this page.

Privacy Statement

"We" fully respect your privacy rights. We hereby formulate this "Privacy Statement" (hereinafter referred to as "this Statement") to inform you of how we collect, use, disclose, protect, store, and transmit your personal data. Please read this Statement carefully. If you have any questions, please let us know.

Personal information refers to various information recorded electronically or otherwise that can identify the personal identity of a natural person alone or in combination with other information. This Statement sets out how we handle your personal information, but it does not cover all processing scenarios. The products or services discussed, mentioned, or introduced in this Statement vary depending on your device type, model, or geographic location. How specific products or services handle your personal information, your rights, and how to contact the data controller will be explained by us in the specific privacy notice or supplementary statement published with that product or service. In addition to this Statement, we recommend that you read the relevant privacy notice or supplementary statement when using specific products or services. This Statement applies only to our IPC series products and their video surveillance-related services. This Statement will help you understand the following:

I. How We Collect and Use Your Personal Information

1. Personal Information We Collect

When you use IPC products or services, you may need to provide personal information, and we will only collect and use your personal information for the purposes stated in this statement. The following are examples of the personal information we may collect:

1.1. Information We Obtain During Your Use of The Service

We will collect information about your device and how you and your device interact with our products and services, including:

- A. Device and application information, such as device name, device identifier, hardware model, application version, software identification code, device and application settings (such as region/language/time zone/font), etc.
- B. Internet Protocol (IP) address.
- C. Log information. When you use our services or view content provided by us, we will automatically collect certain information and store it in logs, such as access time, access times, access IP, event information (such as errors, crashes, restarts, upgrades), etc.
- D. Historical audio and video recordings stored on the IPC or real-time audio and video recordings from cameras connected to the IPC. When used with a mobile app, historical audio and video recordings stored on the NVR or real-time audio and video recordings from cameras connected to the IPC will be uploaded directly to the mobile app to enable remote viewing and listening of video and audio recordings through the mobile app.

1.2. How We Use Your Personal Information

We will use your personal information for the following purposes:

- A. To deliver, activate, or verify the products and services you request, or to modify, provide technical support, and after-sales services for the above products and services at your request.
- B. To send you notifications of application updates and installations;
- C. To push video alarm messages to you or provide remote viewing of IPC video monitoring recordings or real-time video services;

Chapter 6 AI Scenario

6.1 Crossing counting scenario

This is an AI application based on cross-counting functions that helps control the attendance of customers / visitors / vehicles in public places such as restaurants, parks, zoos, theaters, museums, parking lots.

6.1.1 Channel

By single camera counting and viewing real-time results. Mainly used for a single entrance of small places.

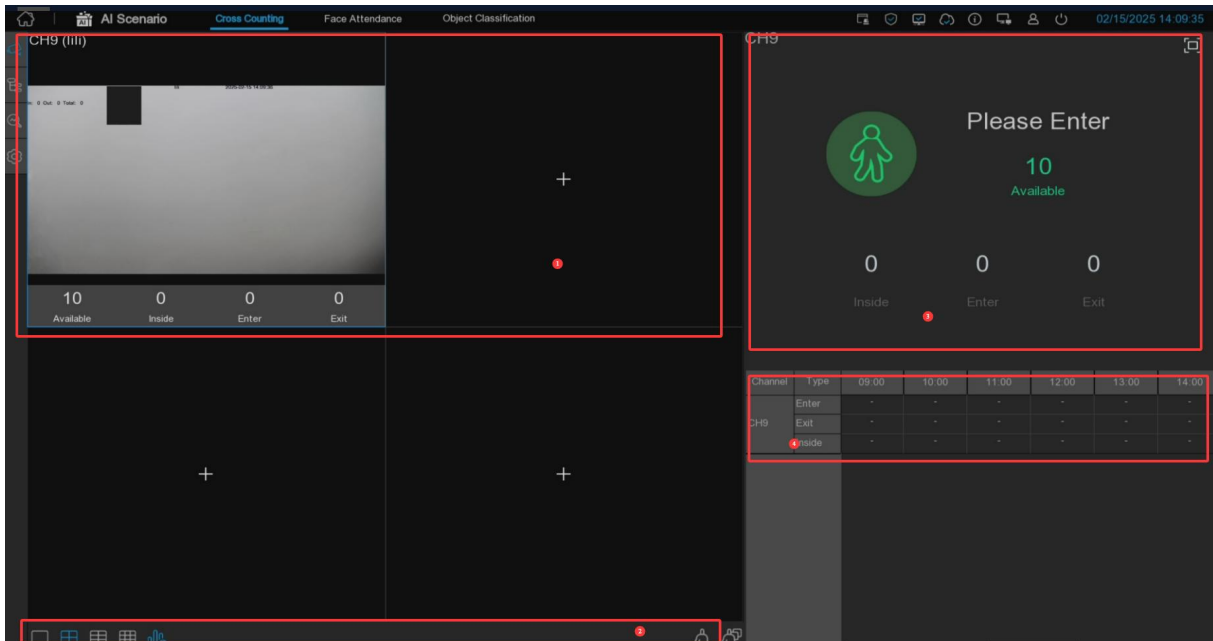

1. Channel drawing and real-time crossing statistical  data, you can select the drawing channel in the Channels in the Settings.







Available: Number of remaining presence allowed

Inside: The current existing quantity in the control area

Enter: Number of entries recorded

Exit: Number of exits recorded

2. Select the number of drawing windows , with  four windows , six  windows and nine windows.  display / hide the statistics under the channel.  clear the current selected channel statistics and clear all channel statistics.

3. Real-time count data information , click to display the total statistics on the full screen.

4. Data of entry and exit information of each channel and each time period.

6.1.2 Group No

Statistics and view real-time results by group. It is mainly used in large places with multi-channel entrances and is monitored by multi-channel cameras.

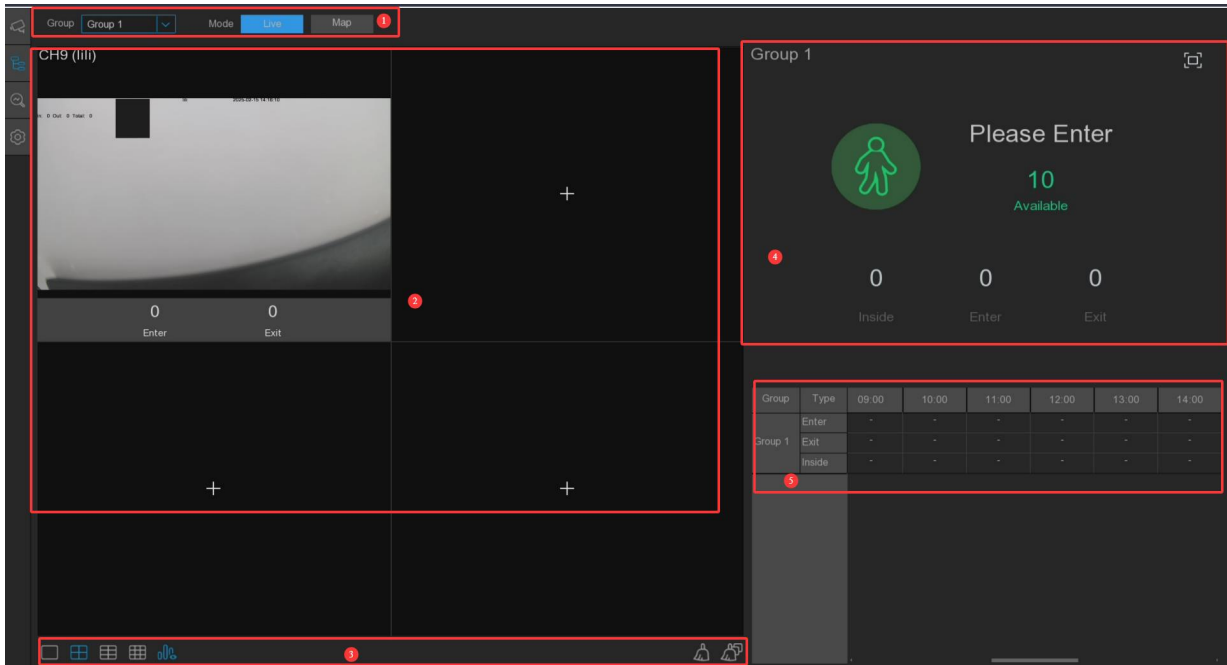







1. Group can select the group information displayed, Live displays the channel preview screen and statistics information, and Map displays the map information.

2. Channel drawing and real-time line crossing statistical  data, you can select each group drawing channel in the Group in the Settings.





Enter: Number of entries recorded

Exit: Number of exits recorded

- Select the number of drawing windows with  four windows,  six windows  and nine windows. click  to display / hide the statistics under the channel. click  to clear the current selected channel statistics and click  to clear all channel statistics.
- Real-time count data information, click  to display the total statistics on the full screen.

Available: Number of remaining presence allowed

Inside: The current existing quantity in the control area

- Entry and exit data information of each group during each time period.
- Map information configuration , click to add a map  picture, click to set the position of the IPC  diagram on the map, click to display the map information and the statistical information of the current group in full screen.

6.1.3 Search

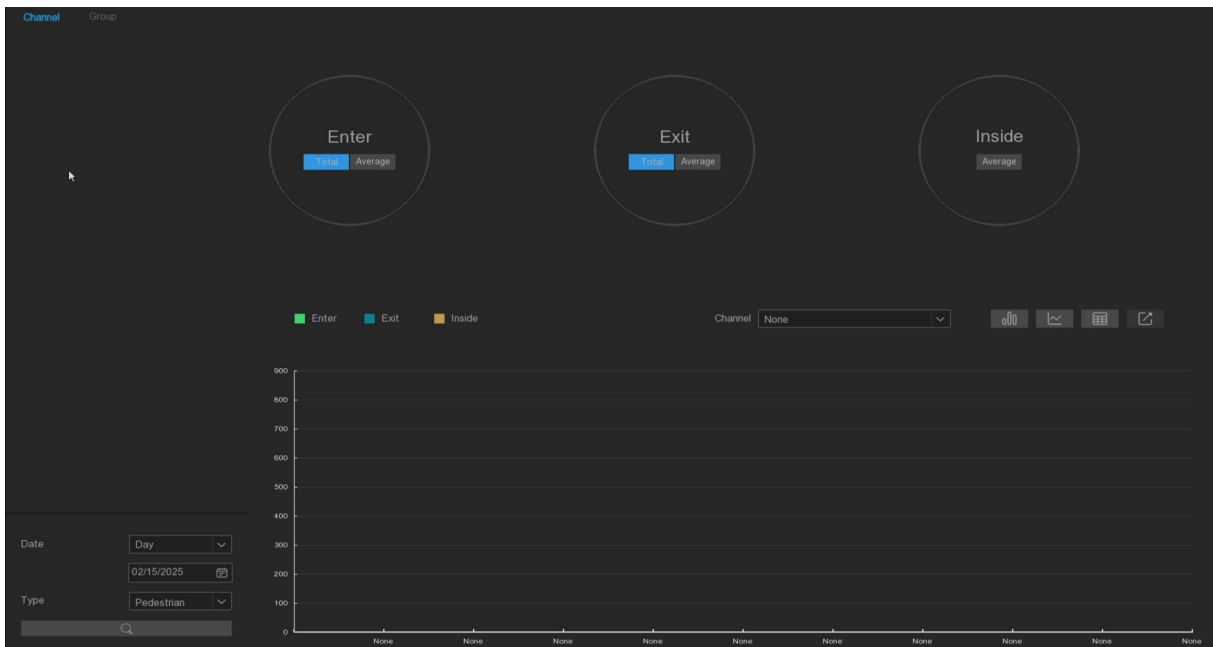

You can search for channels and groups separately. Select the channel or group that you want to search for, set the search duration by day, week, month, or year, and select the target type that

you want to search for. Click the search icon and the results appear on the right side of the window.

6.1.4 Setting-up

Advertising Mode

Advertising Mode Keep Aspect Ratio

Cycle Dwell Time Image File(s) **1**

This feature allows you to set the advertising pictures and choose their display mode (stretched or original aspect ratio). You can also specify the advertising Cycle Dwell Time to control the slideshow frequency.

Channel

Channel	Enable	Max. Capacity	Settings	Alarm	Schedule
CH1 (529+4210poe)	<input type="checkbox"/>	10			
CH2 (30kq824)	<input type="checkbox"/>	10			
CH3 (Camera)	<input type="checkbox"/>	10			
CH4 (Camera823)	<input type="checkbox"/>	10			
111222	<input type="checkbox"/>	10			
(30kq)	<input type="checkbox"/>	10			
Ch	<input type="checkbox"/>	10			

Group

Group	Add IP Camera	Enable	Max. Capacity	Start Time	End Time	Type	Alarm
Group 1		<input checked="" type="checkbox"/>	10	00:00:00	23:59:59	Pedestrian	
Group 2		<input type="checkbox"/>	10	00:00:00	23:59:59	Pedestrian	
Group 3		<input type="checkbox"/>	10	00:00:00	23:59:59	Pedestrian	
Group 4		<input type="checkbox"/>	10	00:00:00	23:59:59	Pedestrian	
Group 5		<input type="checkbox"/>	10	00:00:00	23:59:59	Pedestrian	
Group 6		<input type="checkbox"/>	10	00:00:00	23:59:59	Pedestrian	
Group 7		<input type="checkbox"/>	10	00:00:00	23:59:59	Pedestrian	
Group 8		<input type="checkbox"/>	10	00:00:00	23:59:59	Pedestrian	



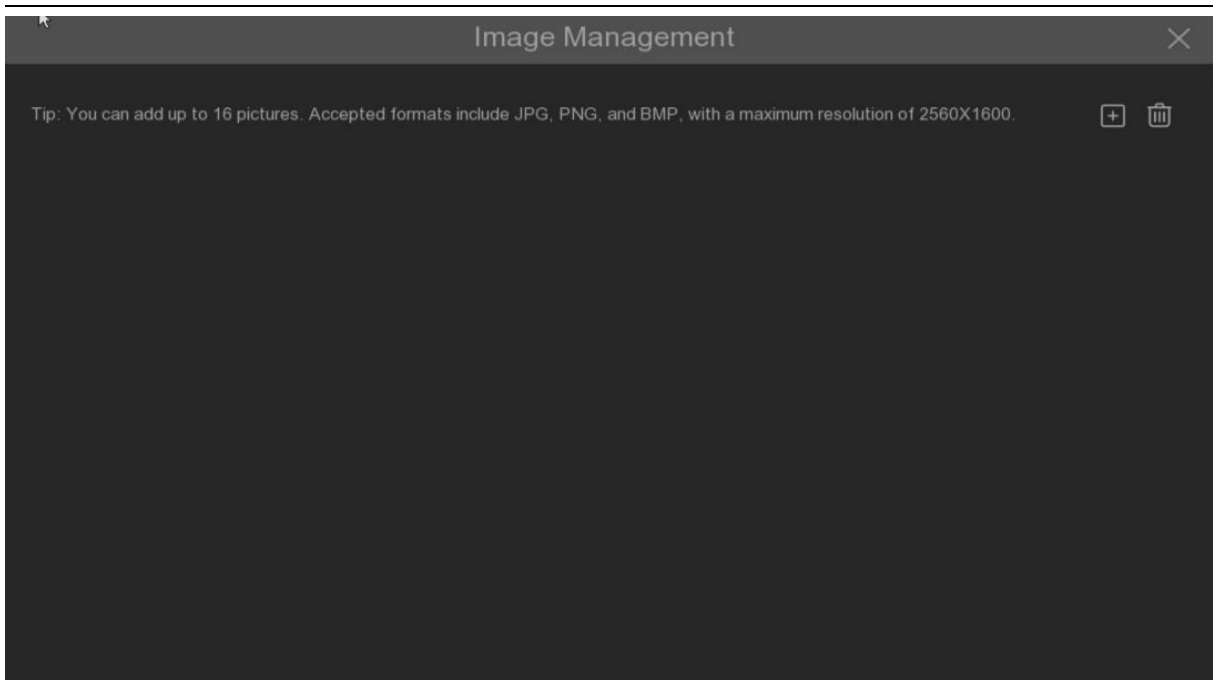

Apply

1. Check **Advertising** mode to open advertising mode. set the picture playback residence time in seconds, the default is 3 seconds. Click the ImageFil (s) button to import the AD images to be displayed from the USB directory, supporting up to 16 images in jpg, png and bmp format, with a resolution not more than 2560x1600.



Click  Add New Picture, and click  Delete the added pictures one by one.

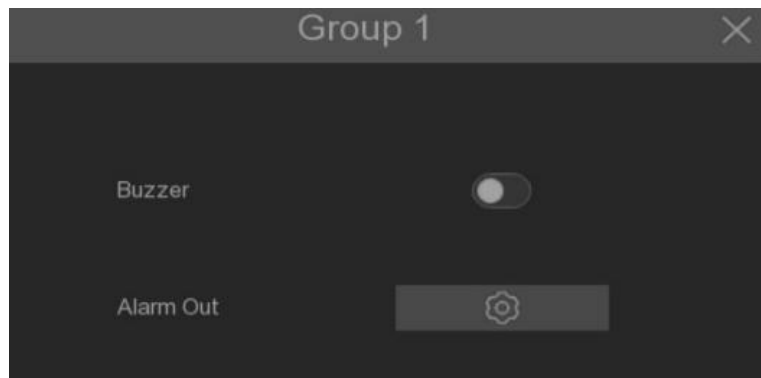

If you want to display an image with the original aspect ratio, select Keep Aspect Ratio. If you want the image to stretch and display in full screen, uncheck the box. Enter the channel mode or group mode, click the full screen button in the upper right corner of the page to display the AD picture and real-time count data.

2. The Set Enable enable box selects which channels to display on the channel page. If the camera in the channel supports AI, the setup  and alarm icons will be blue. Instead, if the camera does not support AI, the icon  will be gray. Set up  the Capacity for each channel, which is the maximum limit for attendance. Click  the configuration detection condition of Setup, and click the Alarm configuration to enter the alarm action when the number is 0.



Buzzer: Set the buzzer duration in seconds when the available number is 0.

Alarm Out: If NVR supports connection to an external alarm device, set the external alarm device when the alarm triggers.

3. Click  the Add IP camera icon to add channels to the group. Up to eight groups can be set, but only one channel can be added to one group. If channels are enabled in channel view mode, they are not allowed to be added to any group. Select the Enable box to activate the group. You can set the number of Capacity per group, Start Time, End Time, detection type (Person, Vehicle and Motion). Click  the configuration of Alarm to enter the alarm action when the number is 0.

6.2 Face Attendance

The full-screen display can record the face attendance in real time and check the attendance results in real time

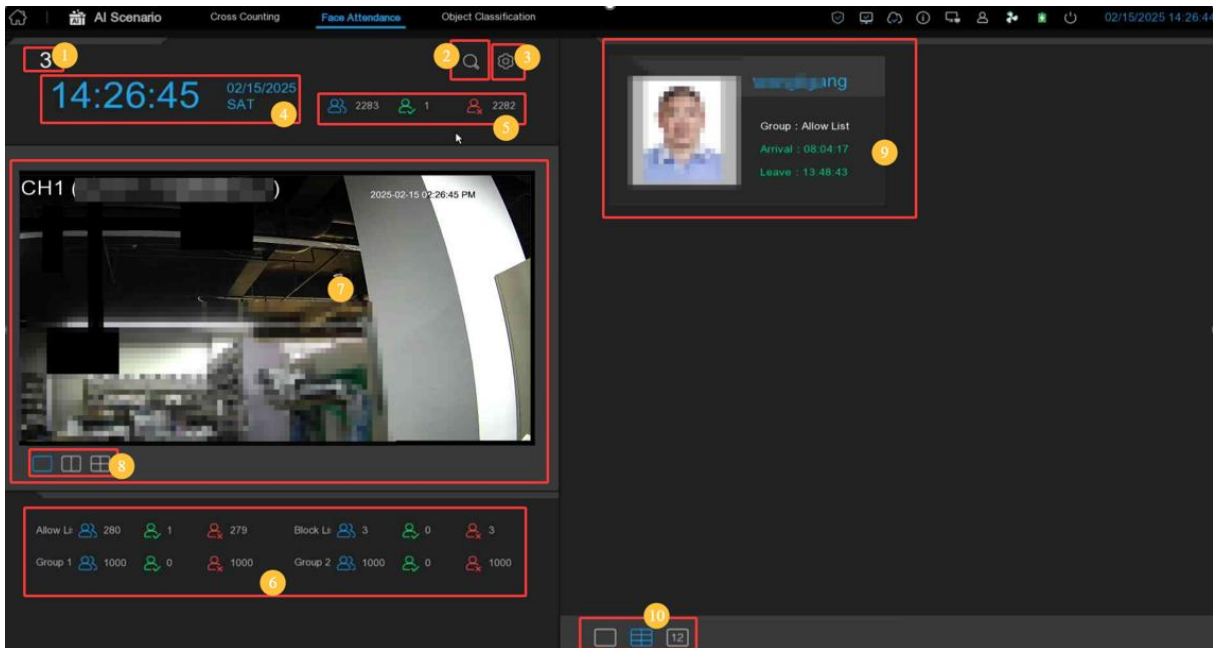

1. Face attendance interface theme.

2. Click  button to enter the playback face attendance search interface, and select the face pictures in the face group by default

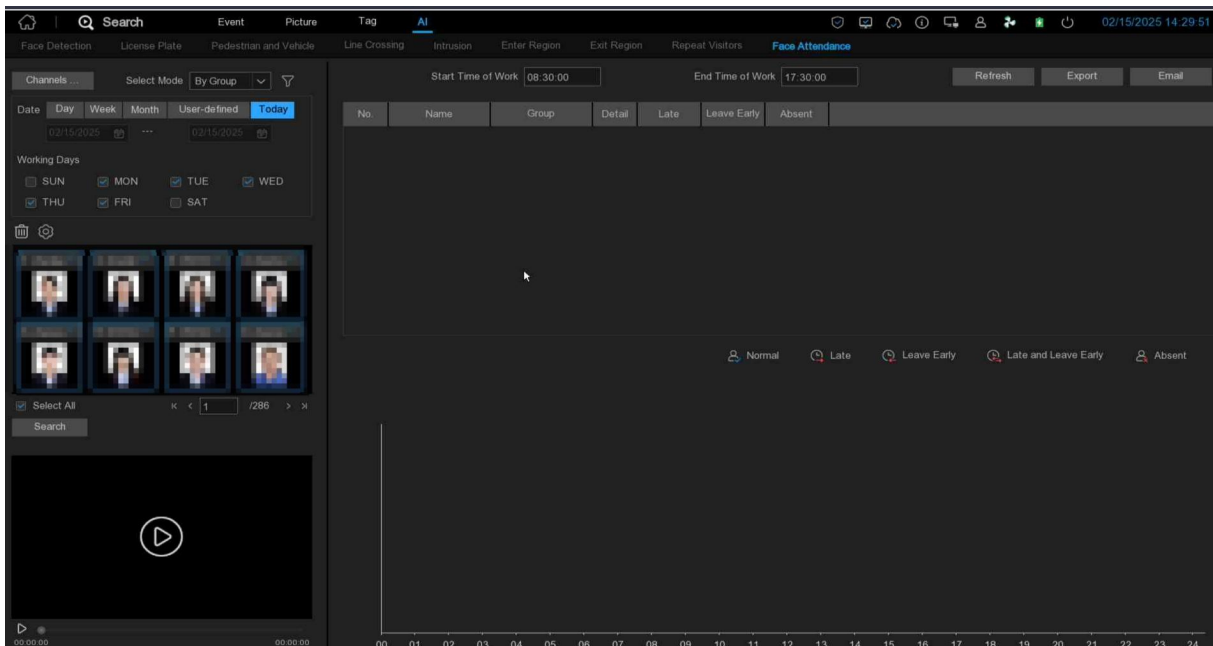

3. Click  to enter the setting interface.

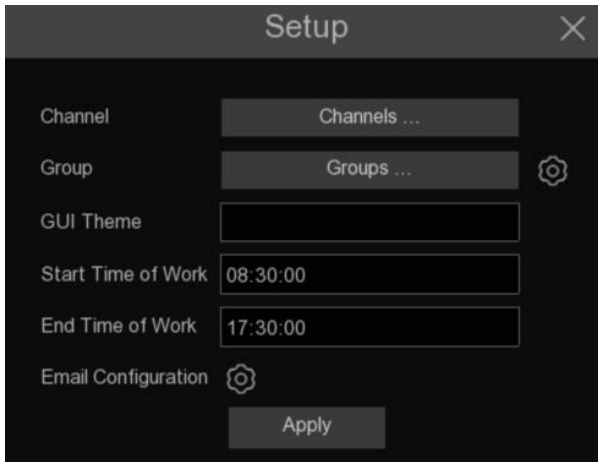

Channels: You can select the attendance channel

Groups: Select the faces of those face groups for attendance , and click on the right

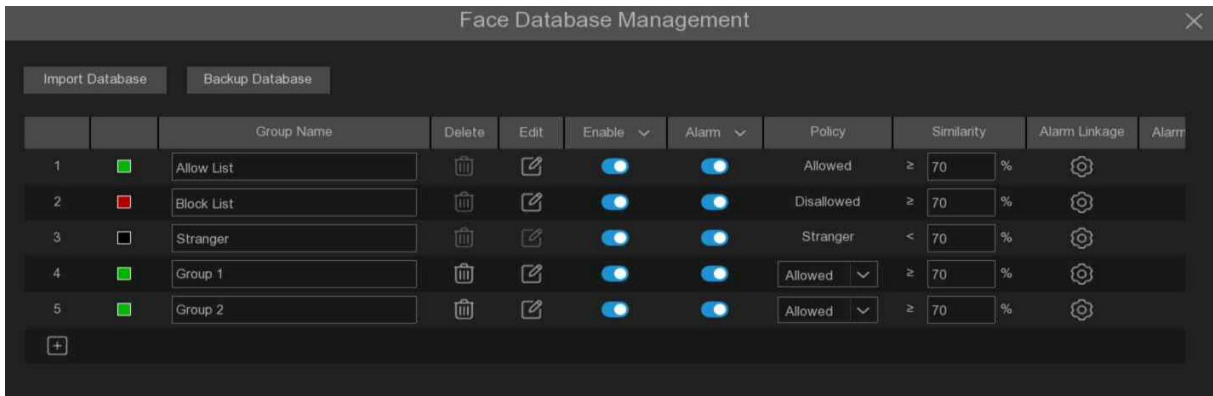

to pop up to the AI face bank setting interface.

GUI Theme: Interface theme

Start Time of Work: Set the working hours

End Time of Work: Set the closing time

Email Configuration: Face attendance result to send the mailbox configuration, click  to send

the face attendance result email configuration

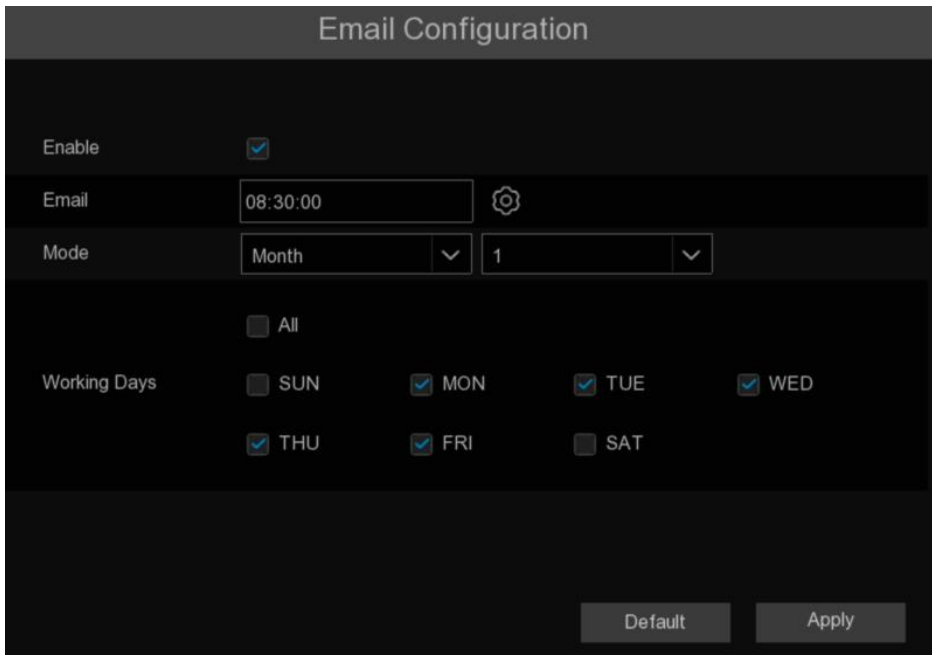

Enable: Open the email to send the face attendance results (the attendance result is a table file)

Email: Set the time for sending the face attendance result email. Click  the pop-up system mail setting interface on the right side of the sending time to configure the system

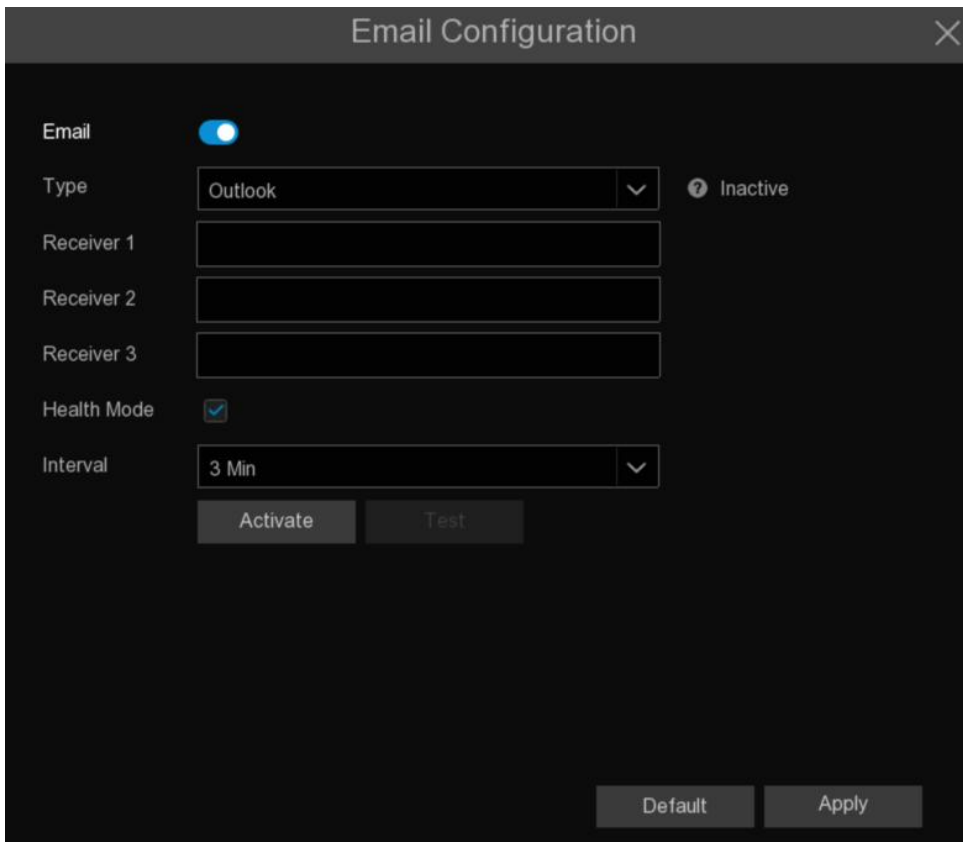

email

Mode: The mode of sending face attendance results is: Day, Week, and Month

Day: Send once a day, send yesterday's face attendance results.

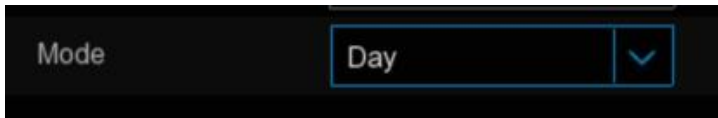

Week: send once a week, can choose the week to send sent face attendance results for the time to send mail forward a week, such as,

Send an email on Monday, and the attendance record is Monday to Sunday

Send an email on Tuesday, and the attendance record is from last Tuesday to this Monday.



Month: send once a month, you can choose the date of each month to send the sent face attendance results for the email time forward one month, such as:

If an email is sent on the 10th of each month, the attendance record is from the 10th of last month to the 9th of this month

That is, if the email is sent on May 10th, the attendance record sent is the attendance record from April 10th to May 9th

Working Days: Select a working day, and select every day is a working day

Apply: Click on Apply to save the settings

Default: Send the attendance email setting to restore the default

4. Show the current date and time
5. Current total number of people attendance situation



Total number of attendance required



Number of attendance



No attendance

6. Attendance status of each face group



7. Channel diagram, the channel can be selected in the Channels inside

8. Select the number of exit windows with  one window,  two windows and



four exit windows

9. Face real-time attendance push, display attendance face picture, name, from the group name, work attendance time and off-work attendance time

10. The interface also shows the maximum number of face attendance push, with



1,



6 and



12

6.3 Non-motor vehicle statistics

Face, human form, motor vehicle, non-motor vehicle detection scene interface full screen display, the detection results can be viewed in real time.

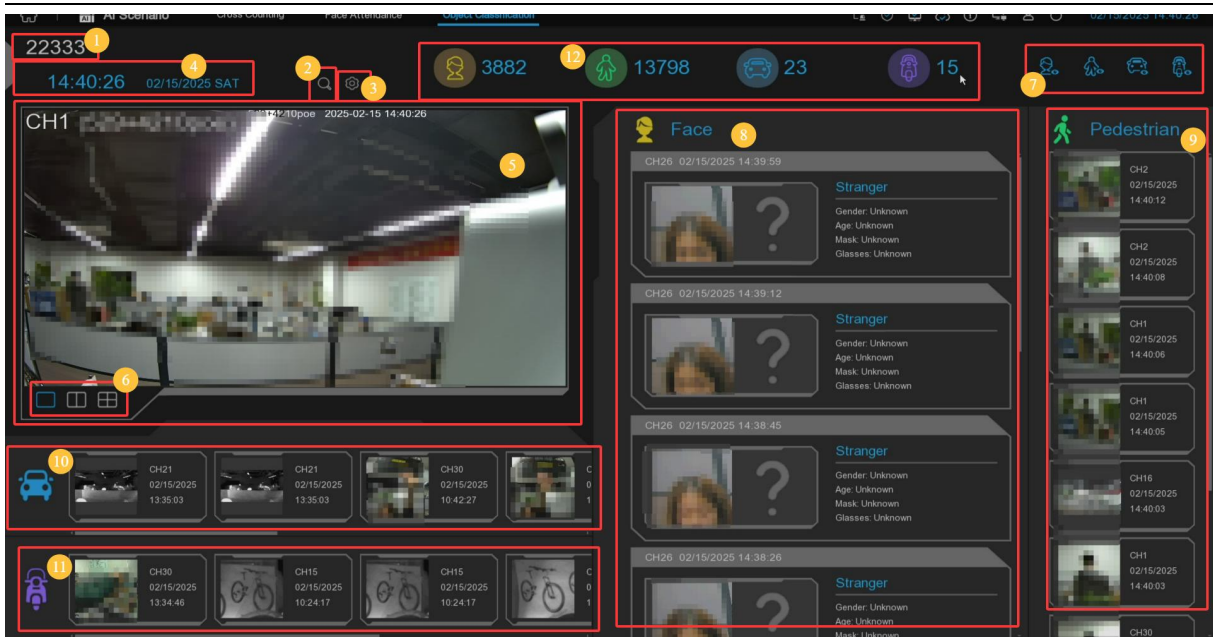

1. The interface theme of computer-nonhuman statistics
2. Click  to enter the playback humanoid model search interface.

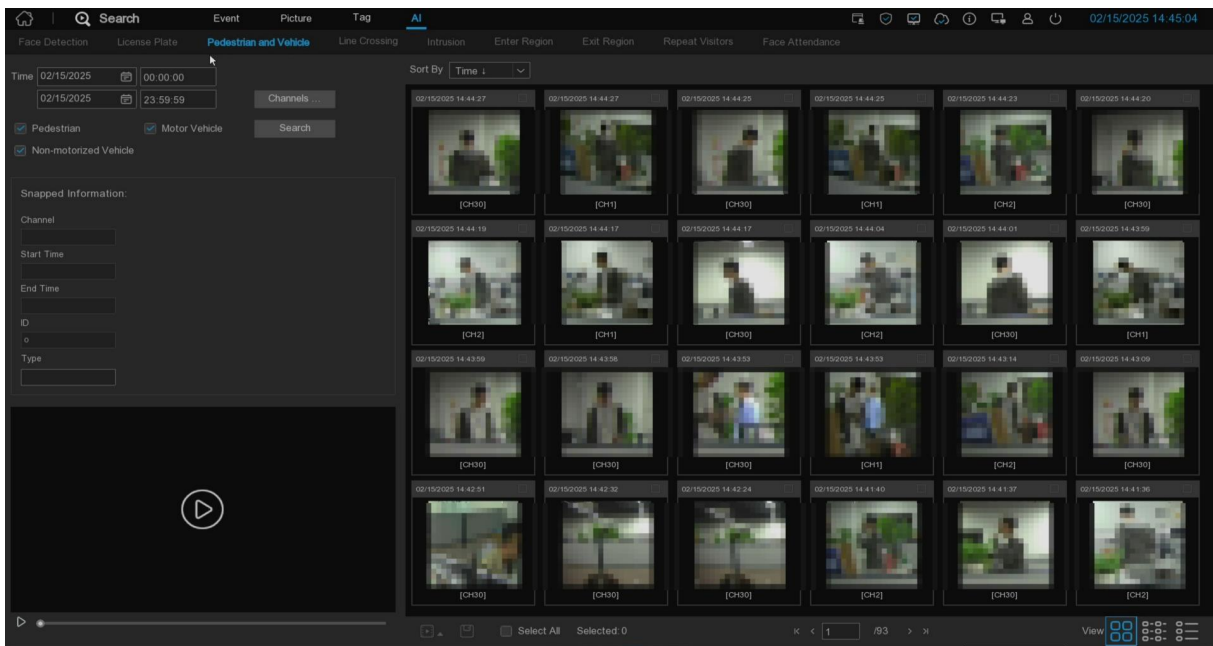

3. Click  to enter the setting interface.

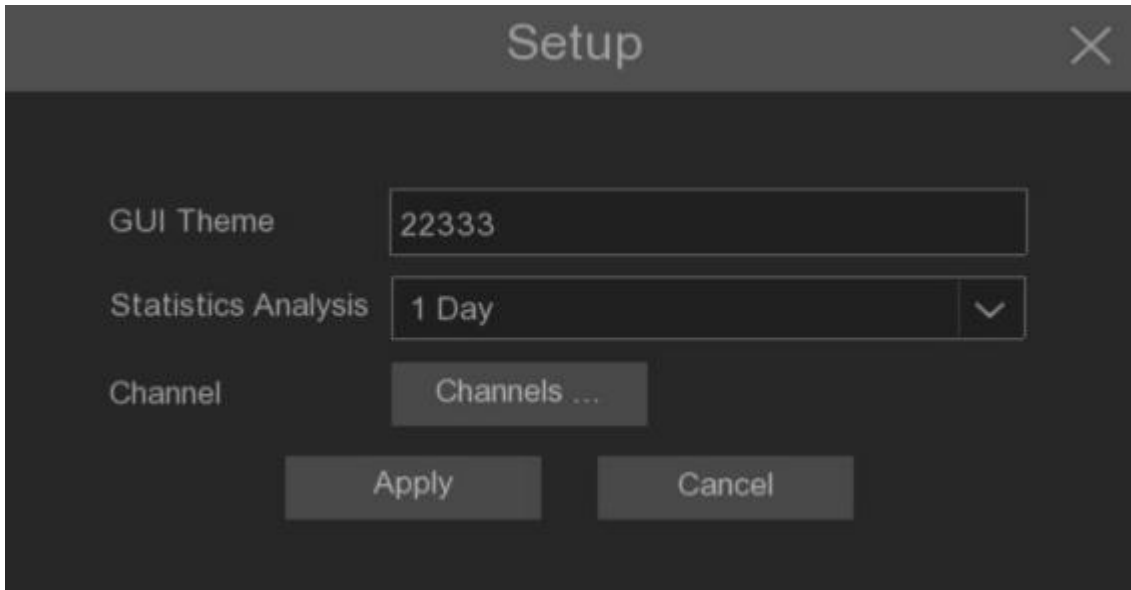



GUI Theme: Interface theme

Statistics: Statistical time, you can choose 1 day, 2 days, 3 days, 4 days, 5 days, 6 days, 7 days, week, month, year.

Channels: Channel selection, you can select the statistical channel.

4. Show the current date and time.

5.  Channel drawing, and the drawing channel can be selected in the Channels inside.

6. Select the number of drawing Windows, with  one window,  two Windows and  four Windows drawing

7. Real-time push display switch, click the icon to display / hide the corresponding detection results for real-time push

8. Real-time push of face detection, showing the detected face picture, the name, and the incoming group name.

9. Real-time push of humanoid detection, display the detected humanoid images, detection channel and detection time



10. Real-time push of motor vehicle type detection, and display the detected motor vehicle pictures, detection channels and detection time

11. Real-time push of non-motor vehicle type detection, showing the detected non-motor vehicle pictures, detection channels and detection time

12. Statistics of the number of human faces, human shapes, vehicle models and non-motor vehicles captured.

Chapter 7 Playback Search and Backup

7.1 Use of the search function

Click  icon to play back and  icon to search in the system menu to enter the search playback interface.

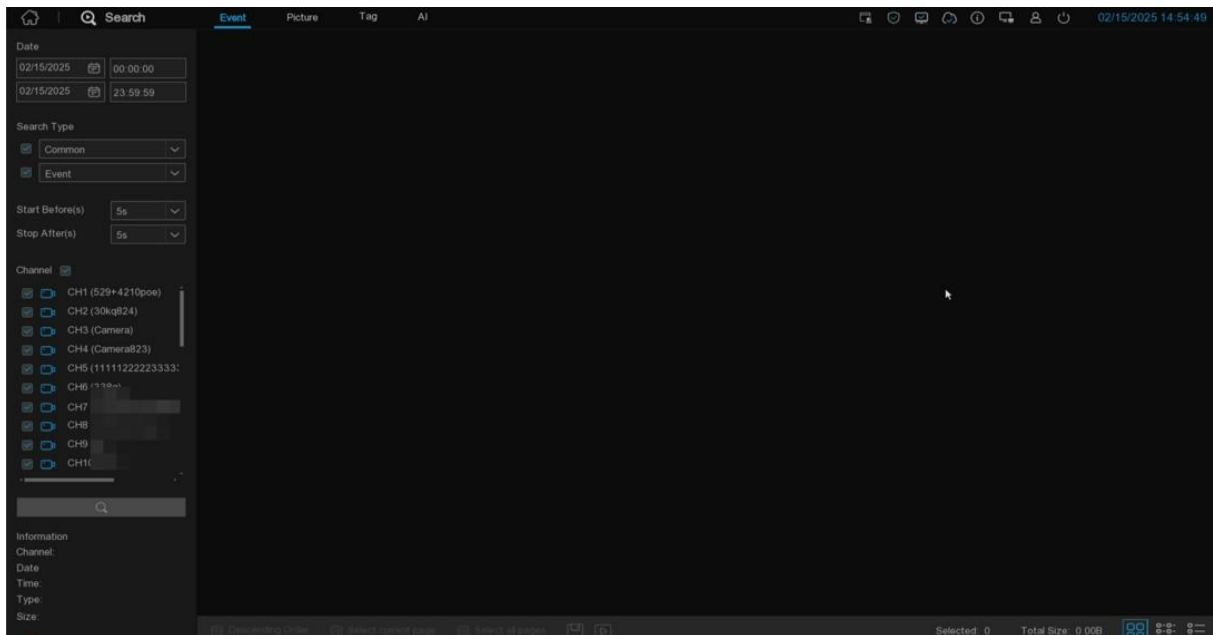
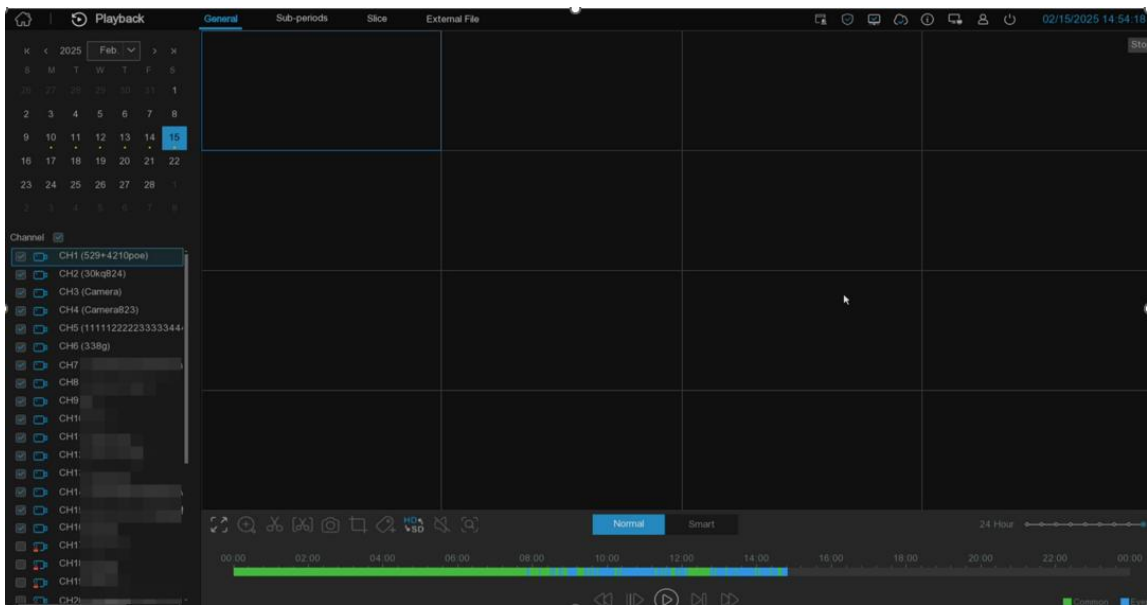

1. **Search options:** The system provides a variety of search and playback methods: general, event, slice playback, intelligent, tag playback, external files, pictures, slice playback, and AI.
2. **Search Date:** Select the playback date.
3. **Channel selection:** Select the channel to search for and play.
4. **Video playback control:** controls the playback of the video.



Enoom video to full screen



Fast pla, with rates x2, x4, x8, and x16



Slow down, with rates 1 / 2,1 / 4,1 / 8, and 1 / 16



Play video



Stop the video



Play by frame: Click to play a video



Fast-forward, with rates x2, x4, x8, and x16



Electronic zoom: Click to zoom in, and then click and drag the camera image during playback to zoom in on the selected area. Right-click to return to the regular play.



Video clip: Quickly save a video to the USB storage directory.





Manually input the backup video time period and save the video to the USB storage directory.



Save the clip video.



Volume control: Roll the scroll bar to increase or reduce the volume.

 **Screenshot:** Capture the images to the USB storage device. If the video playback is in the split screen view, move the mouse cursor to  On the channel you want to capture, then click the icon to save the scratch map.

 Screenshot, capture an area in the video screen saved to the USB storage directory in picture format, or capture the face to import into the face database.

 Switch between main stream and substream video.

 **Add Tag:** Click add tag, pop up the definition window can name the tag.

 **In-Pick mode:** This button is displayed when the camera is connected, and click the button to enter In-Pick mode (some cameras do not support In-Pick function, which is not supported by Slice, External File and AI playback).

 In fisheye mode, this button is displayed when the camera channel of fisheye is played back. Click the button to enter fisheye mode playback (only some NVR models support local fisheye mode)

5. **Timeline:** Continuous videos are shown in green and blue bars, representing different types of video recording (the legend  appears in the lower right corner of the display). Use the time frame () option to view the smaller or larger time periods.





Different types of videos are displayed in different colors:

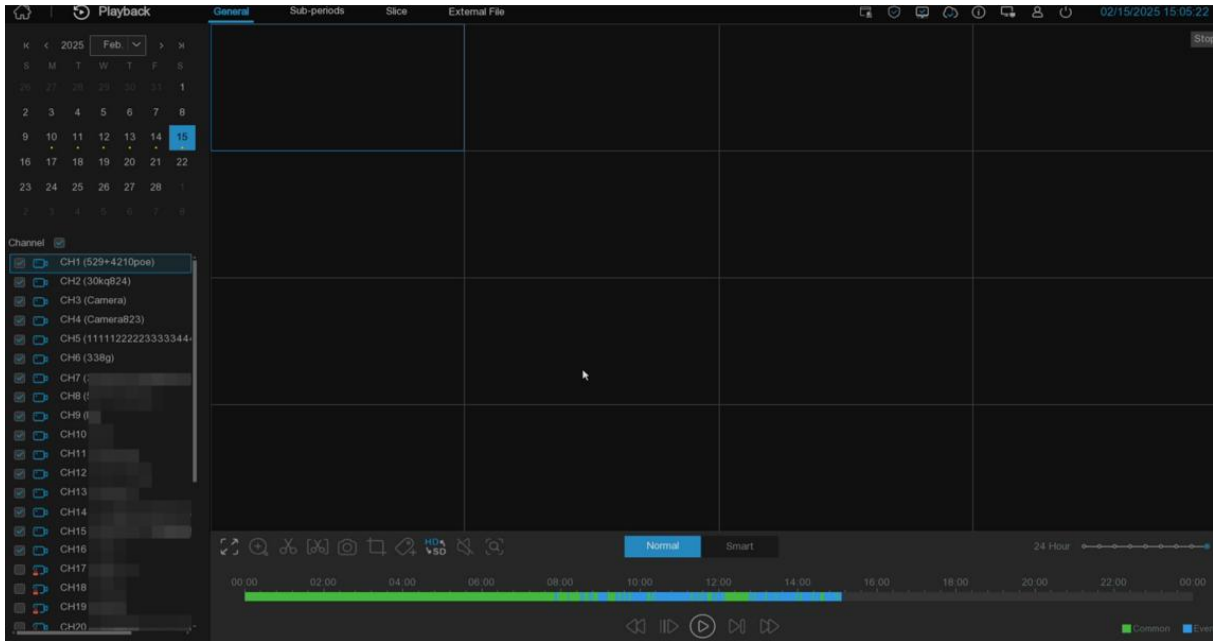

6. **Video playback status:** displays the status of the video playback.



7.1.1 Playback interface search and playback video recording

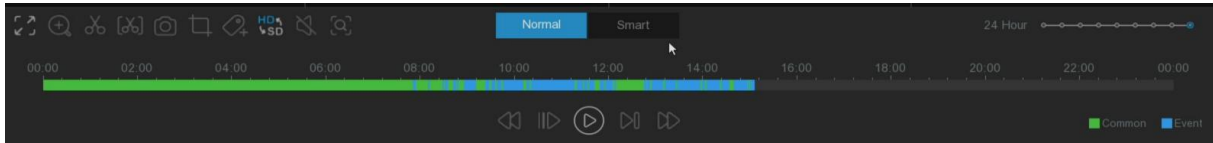

1. Select the search date in the calendar.
2. Select the search channel.
3. Search results will be displayed on the 00:00-24:00 timeline.
4. Click the  icon to start the play.
5. Control the playback by using the icon on the video playback control.
6. Select  or swipe the mouse wheel to view smaller or larger time periods.
7. If you want to quickly save a video during playback, you can use the video  clip backup function.
8. Click Add  a custom tag to make a mark at the current time of the current channel. After the addition is completed, you can jump to the previous "mark" in the label playback interface.

7.1.1.1 Smart pattern



After selecting Smart search, click  the pedestrian type and  vehicle below buttons, and the video progress bar will mark the alarm video of the trigger person and car type in blue. The alarm video of human and car type includes the video of human model events detected by Pedestrian & Vehicle, Intrusion, Enter Region, Exit Region, Line Crossing and SMD.

Click  the Policy Playback button to adjust the playback strategy.

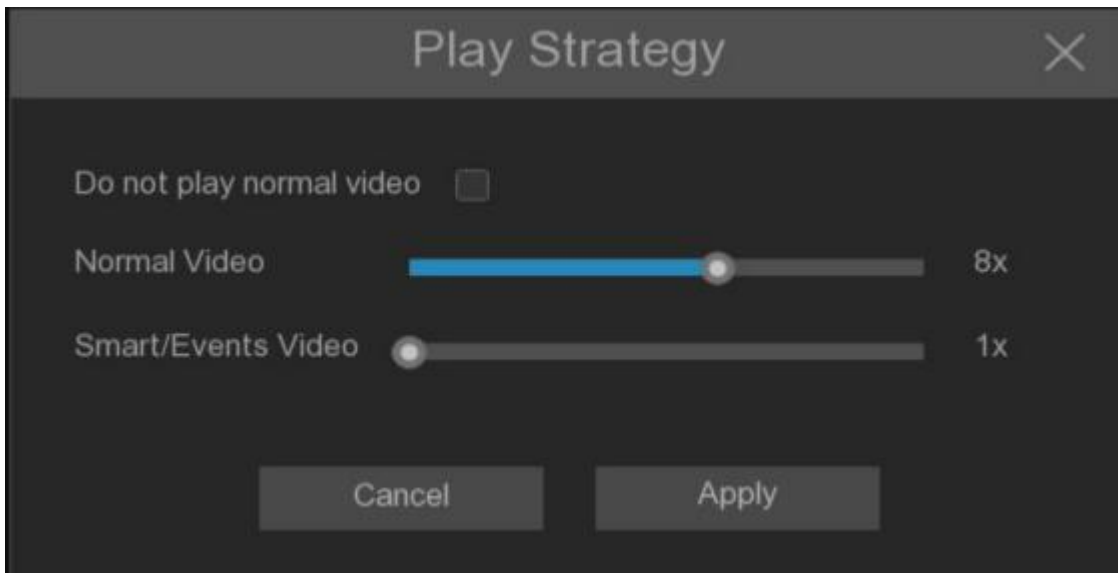

Do not play normal video: Check the Normal event type video of the day will not be played, but only play the alarm event video of the searched human model at the double speed set by Smart / Events Video.

Normal Video: If Do not play normal video is not checked, you can set the double speed for video playback to the Normal event type. After **Do not play normal video** is checked, the popup will be displayed.

Smart / Events Video: Set the double speed of the alarm event video played to a human model.

Note: Only single channel search playback main stream video is supported in Smart mode.

7.1.1.2 Motion Search

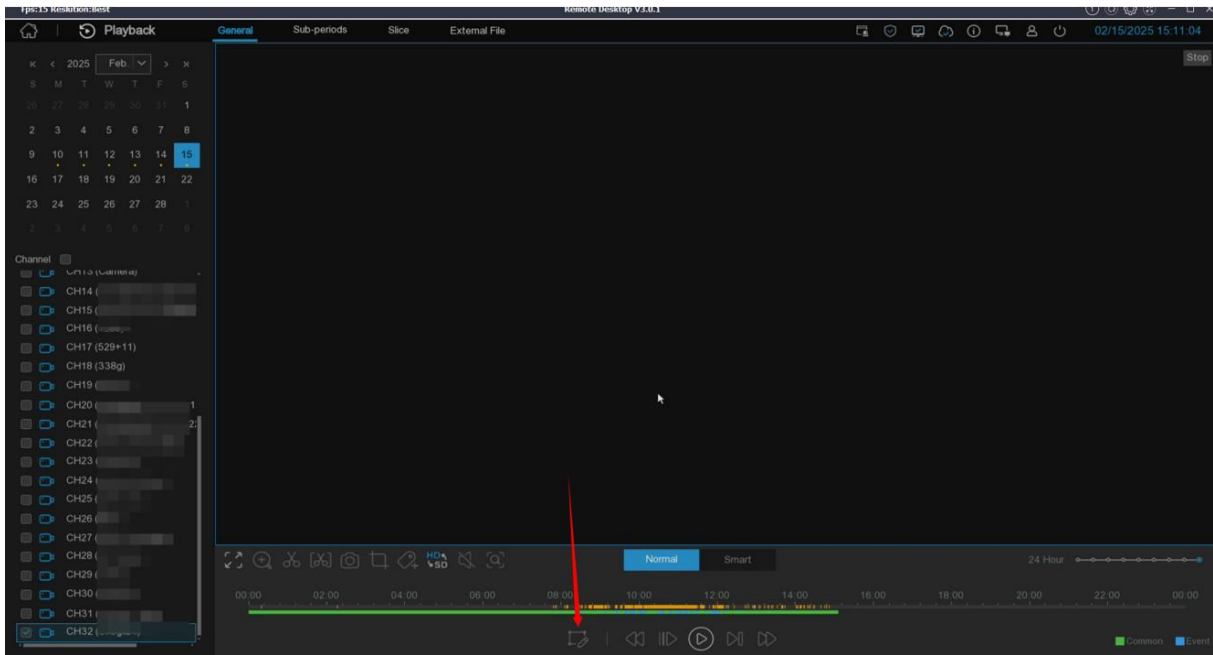





The device detects a Motion-Search type, which is displayed in yellow in the time bar below the progress bar. Click  to enter the Motion-Search locating interface.

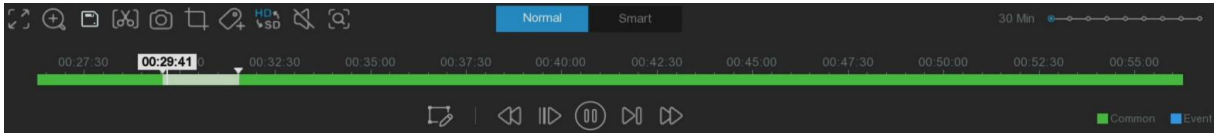

The red box is the selected area. If there is a picture change in the area, it will be searched out and mark the time bar with yellow.

7.1.1.3 Video clip backup



1. Insert the U disk into the NVR.
2. Select the backed-up channel to start the video playback.
3. Click  the clip icon.
4. Move the mouse cursor to the timeline in which to start the video clip.
5. Hold down the left mouse button and drag the cursor to the timeline where you want to end the video clip.
6. When the icon  changes to the icon , click the icon  to save the clip of the video clip.
7. Select a file type for the backup file, and click the Save icon to save the video clip. Please make sure that the USB storage directory has enough space to save the video clips.

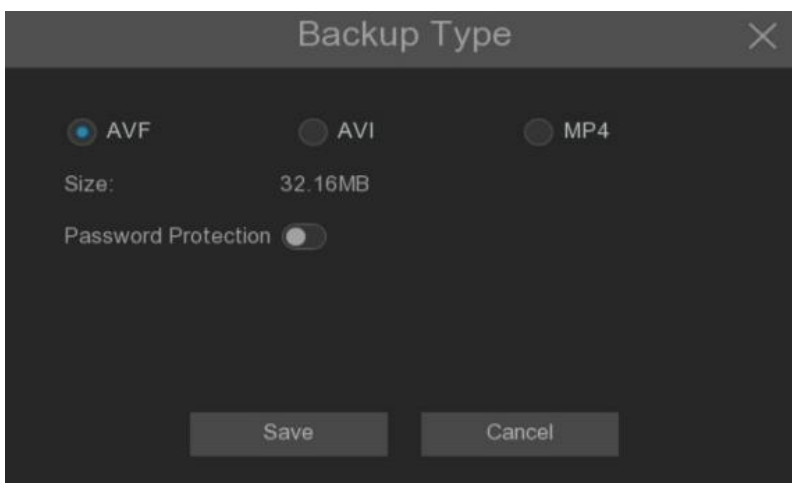

8. The Backup menu page appears to select the directory to be saved
9. Click OK to start a backup. The progress bar at the bottom of the window shows the progress of the backup.

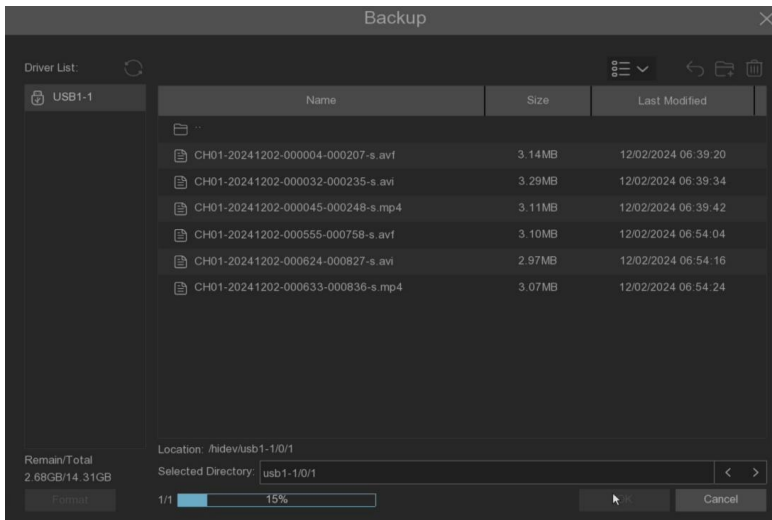

7.1.2 Sub-Periods

Sece playback can play event video of multiple periods in a single channel. The searched video period will be split according to the selected split screen mode. For example, if the searched event video time is 60 minutes long and the split screen is x 4, each split screen will play for 15 minutes.

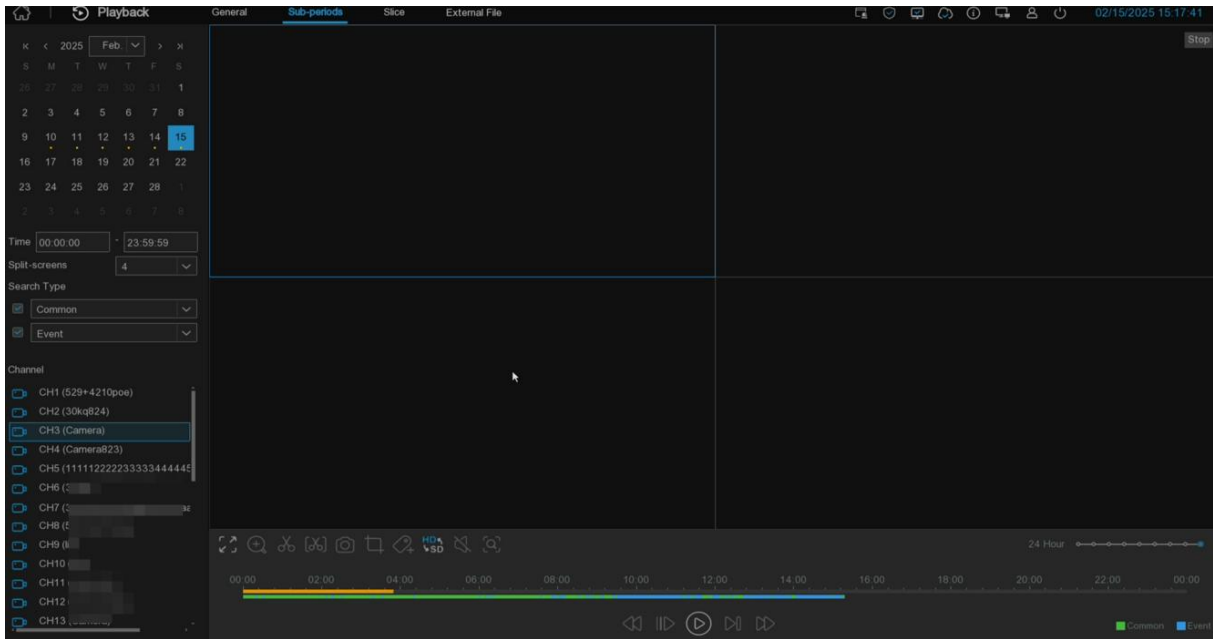

Strip search for playback video:

1. Select the date and time of the search.
2. Select the number of split-screen plays for the video channel.
3. Select the type of video that you need to search for, or select All.
4. Select stream type and search channel (only one channel)
5. Click the play icon  to start the play, and control the play by the icon on the video playback control.
6. Click the left mouse button on a specific split screen, and the time period of the video split screen will be displayed on the timeline. The color bar at the top of the timeline indicates the time span of the video split screen that you clicked on. The color bar at the bottom of the timeline indicates the time span of the entire video already searched.

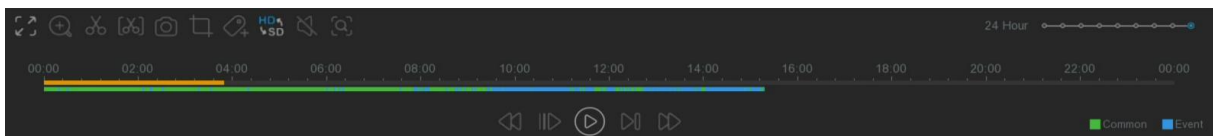

7. Select  or swipe the mouse wheel to view smaller or larger time periods.

7.1.3 Slice Playback

The page refines the video of the search to every minute display.

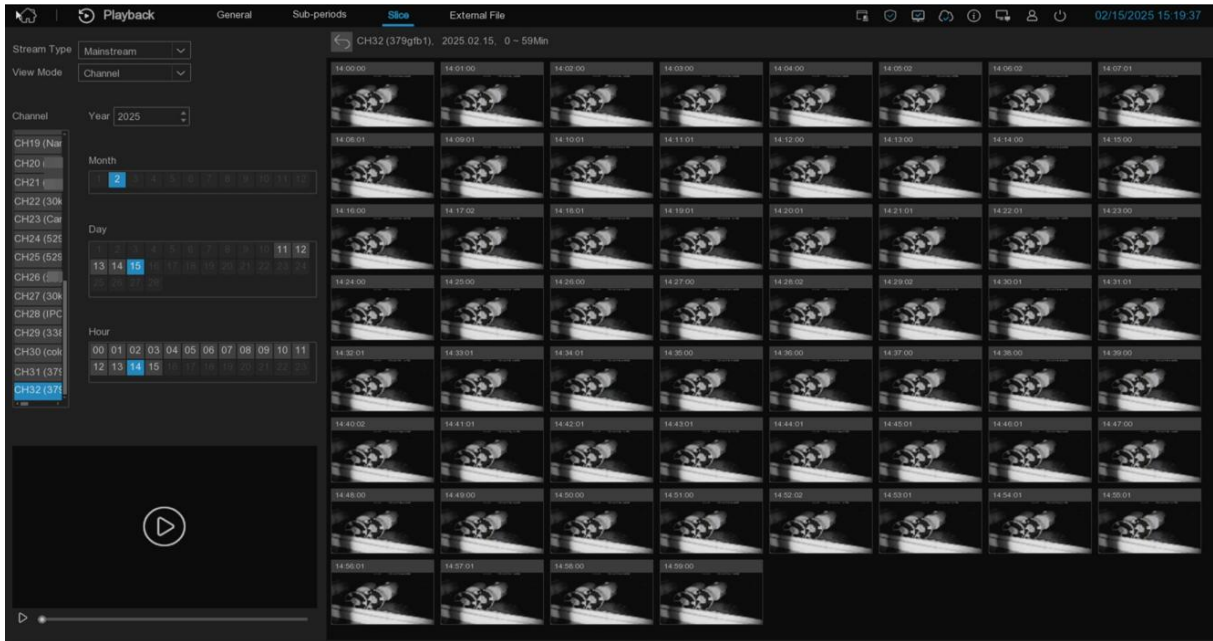

Select Code stream, Channel, Month, Days, and Hours, then, to display 60 current hours on the right, each for 1 minute. Click to do a simple playback in the  lower corner. Click to access the normal playback.

View mode: If you choose the channel (Channel), the selection before the search can only select the channel first, and if the time (Time), the selection before the search can only be selected first.

7.1.4 External files

You can play the video file in the external U disk, select the left file list, and click the play button to play.



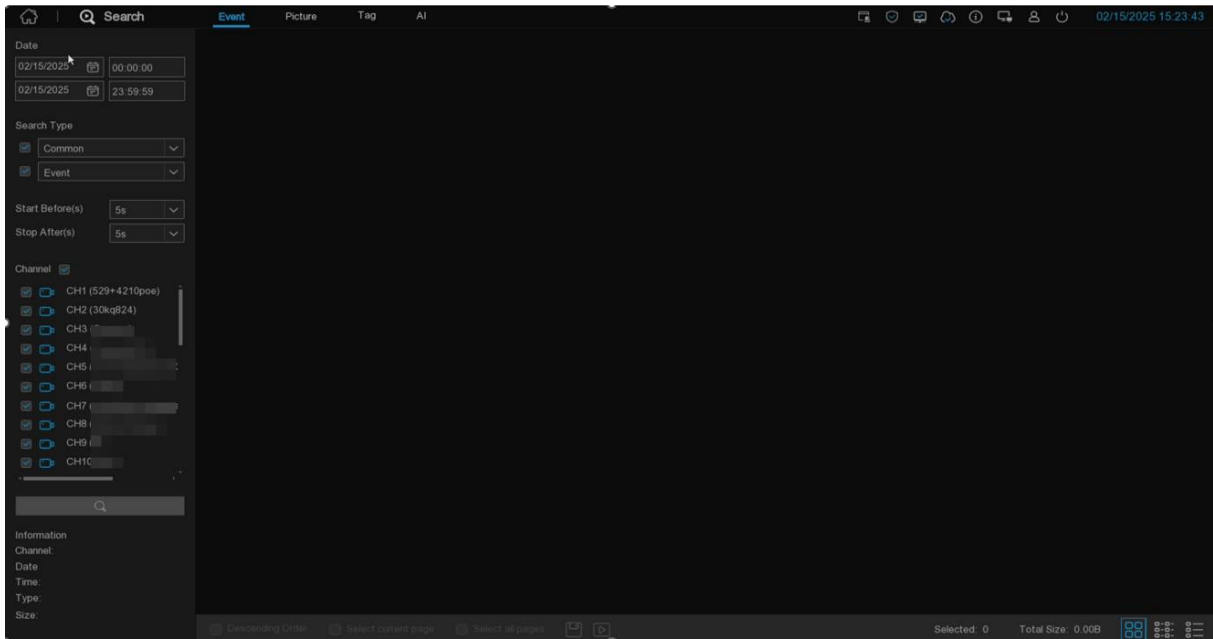

7.1.5 Event search, playback, and backup

Through the event search page, you can view the list of each event video, showing detailed the channel, start and end time, memory size, and event type of each event.



Event search, playback, and backup:

1. Select the date and time that you want to search for.
2. Select the type of video that you need to search for, or select All.
3. Select how long it takes the event to start playing. how long it ends.
4. Select the channel that you want to search for, or select all of the channels.
5. Click on the search  icon to search.
6. Events that meet the search criteria are displayed as a thumbnail view. Double-click one of the events to play the event video immediately.
7. Clicking the icon in the lower  right corner of the menu can browse between event pages or enter the page to browse.
8. Switch the view of the list form by clicking the icon in the lower right corner of the screen:



 Thumbnail view: You can view the snapshots of the event.

 List View: Events will appear in the list.

 Details View: You can view the details of the event.

In Detailed View mode, video events to prevent them from being covered by  the hard disk.

Click the icon  to lock or click the icon to unlock the event.





9. When the left mouse button is clicked on the event, the event information is displayed in the lower left corner of the screen.
10. In descending order: arrange the file list in descending order.
11. **Select:** Select the check box before Event Number to select events, the check box before Select Current Page to select all events in the current page or the check box before Select All Pages to select all events.
12. The selected number of files and total size information will be displayed in the bottom right corner of the screen.
13. After selecting File, click the icon  to save the video to the U disk, or click the icon  to enter the event playback control window to play the video.

7.1.6 Picture search

This page can search for all images saved to the hard disk.



Search, play, and back up the images:

1. Select the date and time of the search.
2. Select the picture capture type you want to search, or Search Type to select all.
3. Select the channel to search for
4. Click on the  icon to start the search.
5. Pictures that meet the search criteria are displayed in a thumbnail view. Click the button  in the upper right corner of the  thumbnail to view the image, and click the button in the middle of the thumbnail to play the front and back video of the time point of the image.
6. Clicking the icon in the lower  right corner of the menu can browse between event pages or enter the page to browse.
7. Switch the view of the list by clicking the icon in the lower right corner of the screen below.

 **Thumbnail view:** View a picture of the event.



List View: The picture appears in the list.





Details View: View the details of the picture.

8. When you click the left mouse button on one of the pictures, the system displays the picture information in the lower left corner of the screen.

9. **Select:** Select the check box before Image Number to select images, the check box before Select Current Page to select all images in the current page or the check box before Select All Pages to select all images.

10. The selected number of files and total size information will be displayed in the bottom right corner of the screen.

11. After selecting File, click the icon  to save the picture to the U disk, or click the icon  to enter the event picture playback interface.

7.1.7 Tag playback

This page can view all added tags and edit, replay, or delete. Select the time and channel to click



to complete the search. Click  to jump to the position marked by the label for playback.

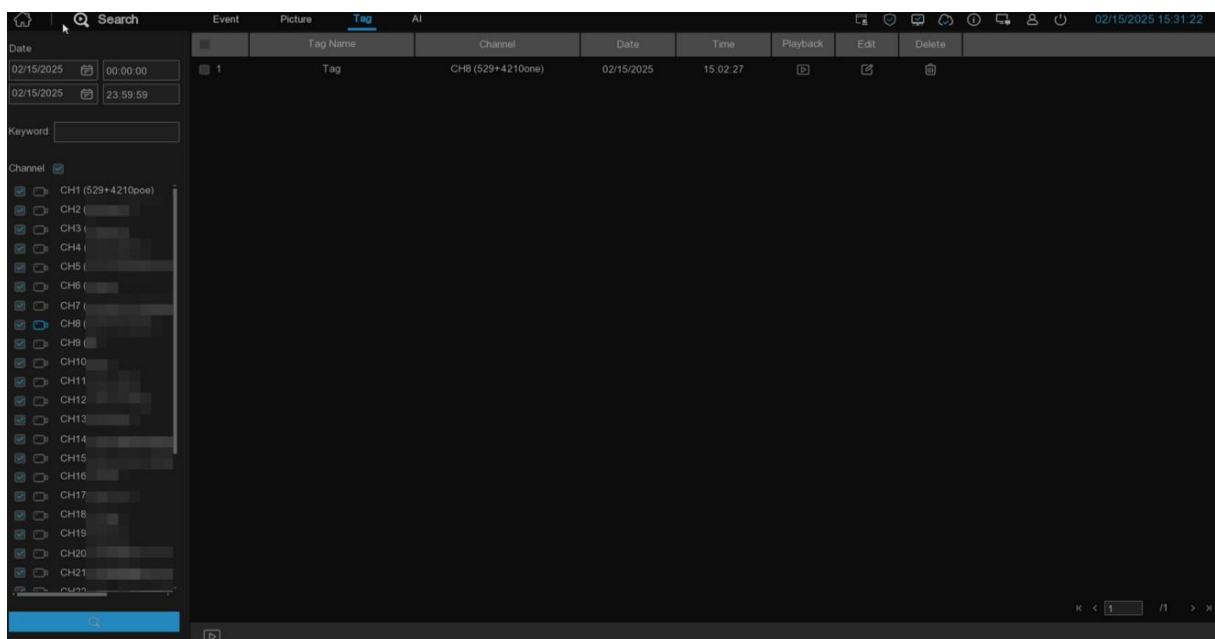



Keyword: Enter the keyword in the label name for accurate search.

7.1.8 AI

7.1.9.1 Face

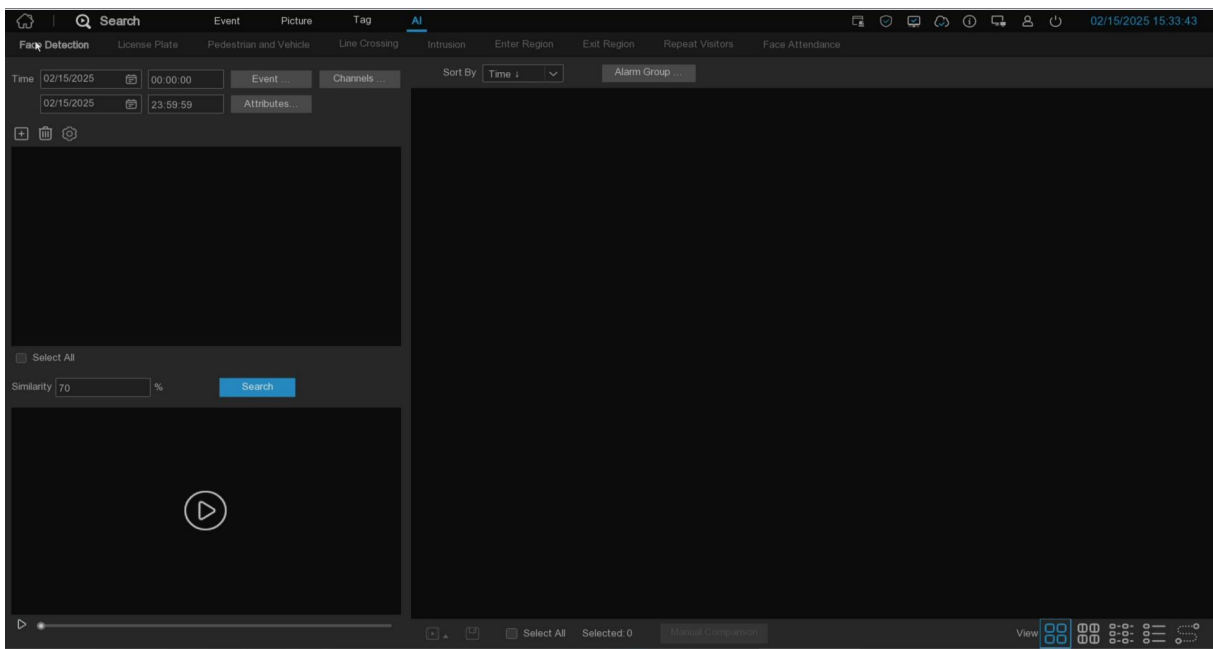
After selecting the date, time, channel and face event, click search to search the all face information of the event during that time.



1. Click  to customize the added search face. Or select Event Select All Face Event for contrast search.

Face recognition alarm: Face recognition after enabling Alarm linkage.

Frequent persons alarm: trigger the face grasp map after personnel frequency analysis and alarm.

Others: Face recognition after not enabling Alarm linkage and face capture after triggering face detection.

Note:

A. Face recognition refers to face alarm detected after importing face information and enabling at least one face group. face detection means no face information or imported face letter information but all face group is not enabled.

B. Aarm linkage refers to the Alarm enable switch on the face database page, as shown in the below picture.

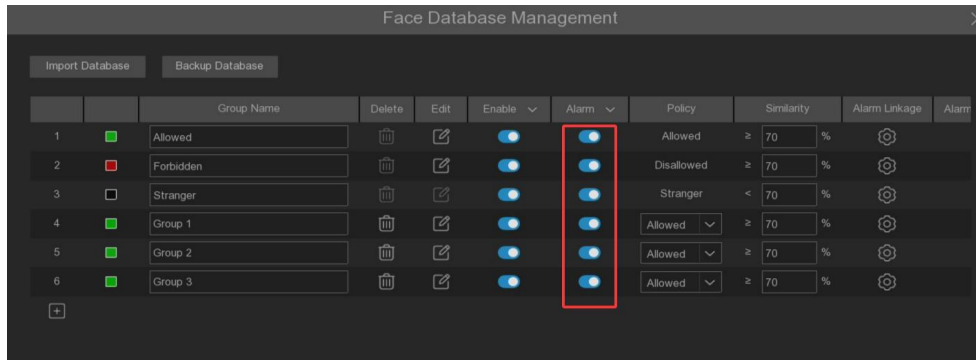

2. Click Channels to select the channel for the search
3. Click Attributes to set the face attribute conditions for search, select Gender, Age, Mask, glasses Glasses and expression Expression
4. Select Alarm Groups Select the face group with the face contrast
5. Select the picture in the search area, click to delete the picture, and click to pop up to the face database setting interface.
6. In the search results, right-select Import To to import this image into the face library grouping.
7. Right-select Detail Information in the search results to view the details of the face.
8. Click Custom Playback to enter the time when the face is detected for playback.
9. Click to view the different viewing methods.

7.1.9.1.1 Face track map

Click on the lower right corner to enter the electronic track chart menu.



Click Load Map to pop up U disk, select map Add. Check  Edit to drag the IPC icon to the place you want to place and unexit edit mode. Then click, select the face from the local face library or U disk, click search (only support the search for one face), you can search out the IPC that has detected the face, and there will be a color mark on the map.

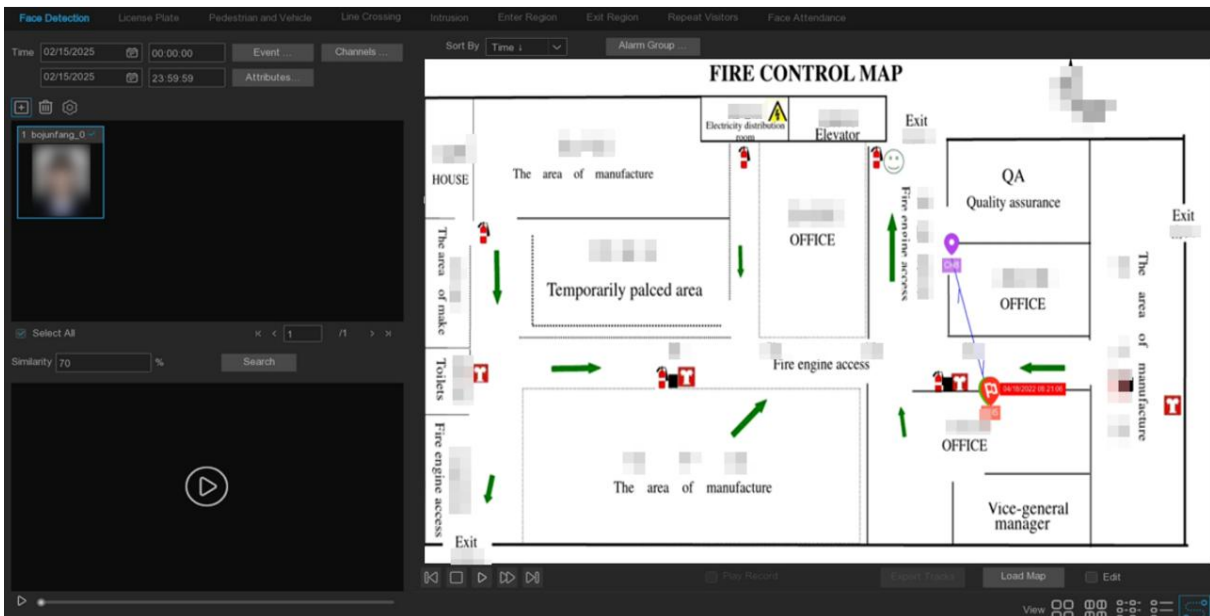

If you click the left button on an IPC icon and play it back, there will be a simple playback in the lower right corner. If more than one IPC detects the face, the click player will automatically determine the person's movement and introduce an arrow.

7.1.9.2 License plate

If the camera turns on the license plate detection, triggers the alarm and records the video, view the video details or export it in this interface.

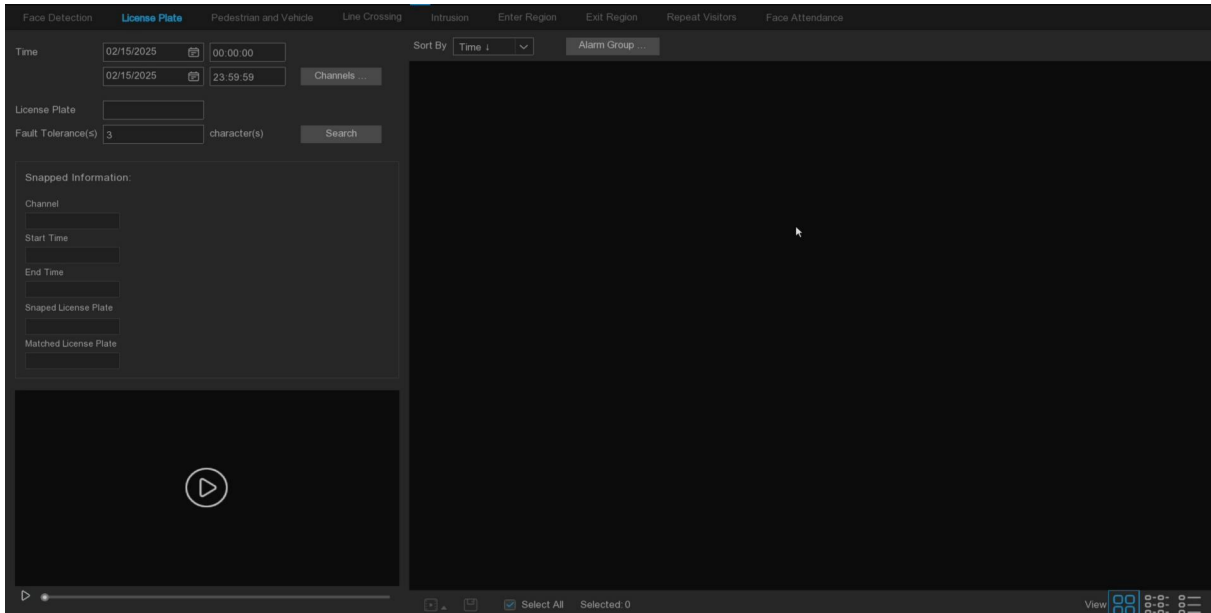

Time: Set the time period. The date can be set by clicking. 

License Plate: Screen and query according to the license plate information.

Fault-tolerant: Fault tolerant character, which allows the number of characters inconsistent with the set license plate number. The lower the setting, the higher the matching degree of the search results.

Note: If you want to search for the target license plate by entering only a few characters, the fault tolerance rate can be set to the maximum. At this time, many unrelated license plates will be found, but the search results are sorted by similarity, similar and high license plates are in front, and you can find the desired target license plate.

Snapped Information: Details of alarm events have the following five items:

Channel: Video shooting channel in the event.

Start Time: Start time of the event trigger.

End Time: End time of the event trigger.

Snaped License Plate: The camera captures the license plate number by taking the license plate photo.

Capture License Plate: Compare the license plate number obtained from the database.

Sort By: Event videos are sorted by time.

Channels: License plate detection events triggered by each channel can be searched.

Search: Query according to the selected settings.

Alarm Group: Select different groups in the database to compare and search to display the results.



This function is to click the triangle icon in the lower right corner of the event video to select the delay of playing the video. There are the following: 5s, 10s, 20s, 30s, 1min, 2min, 5min, 10min, Custom Playback. If 30s is selected, the video will be extended by 30 seconds each.



Video can be backed up to U disk, and the video format supports AVF, AVI and MP4.



All the videos selected and the number of videos selected.



Click to turn the page.



Click to select different views.

Select an event right-click gives two options:

Detail information: View the event details.

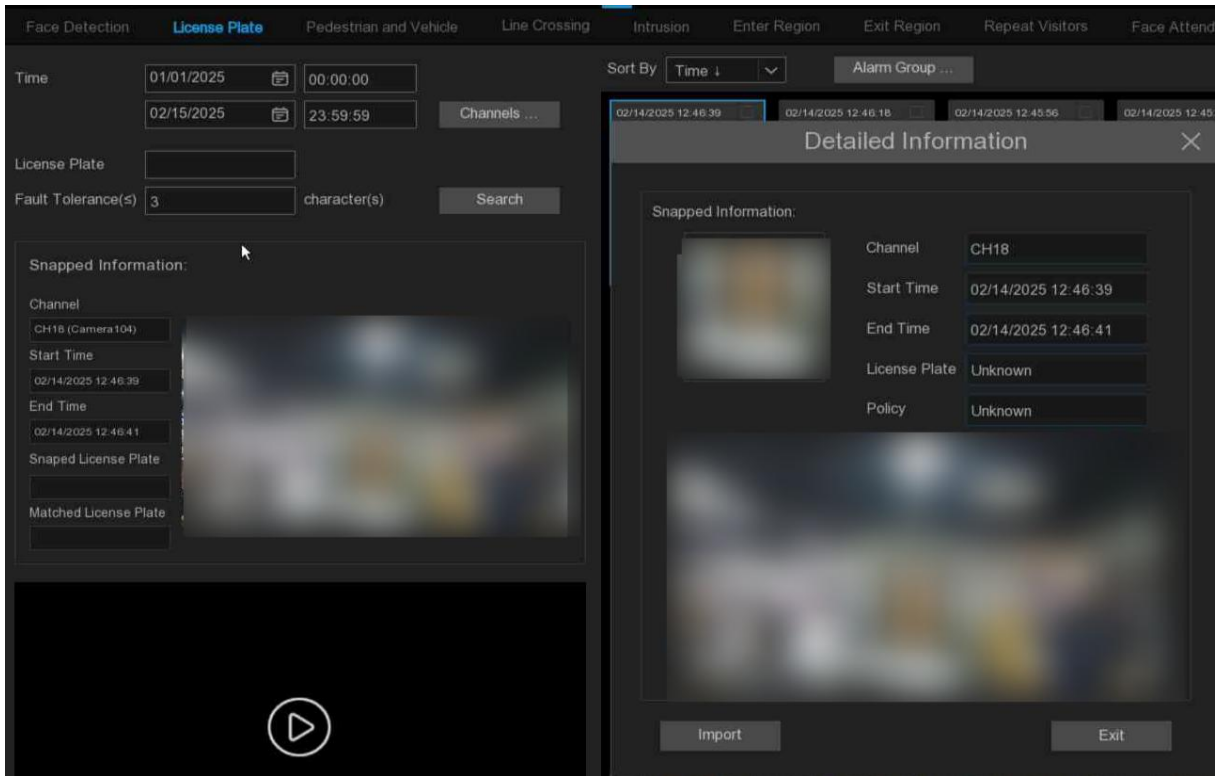

Custom Playback: Playback setting, click, you can set how long the event plays in advance and how long the delay will end. The maximum time period was 10Min.

Double-click the event or drag to the lower left corner to play the event video.

7.1.9.3 Pedestrians and vehicles

After selecting the date, time, passage, pedestrian and vehicle type, click search, you can search for all pedestrian and vehicle information in this time period.

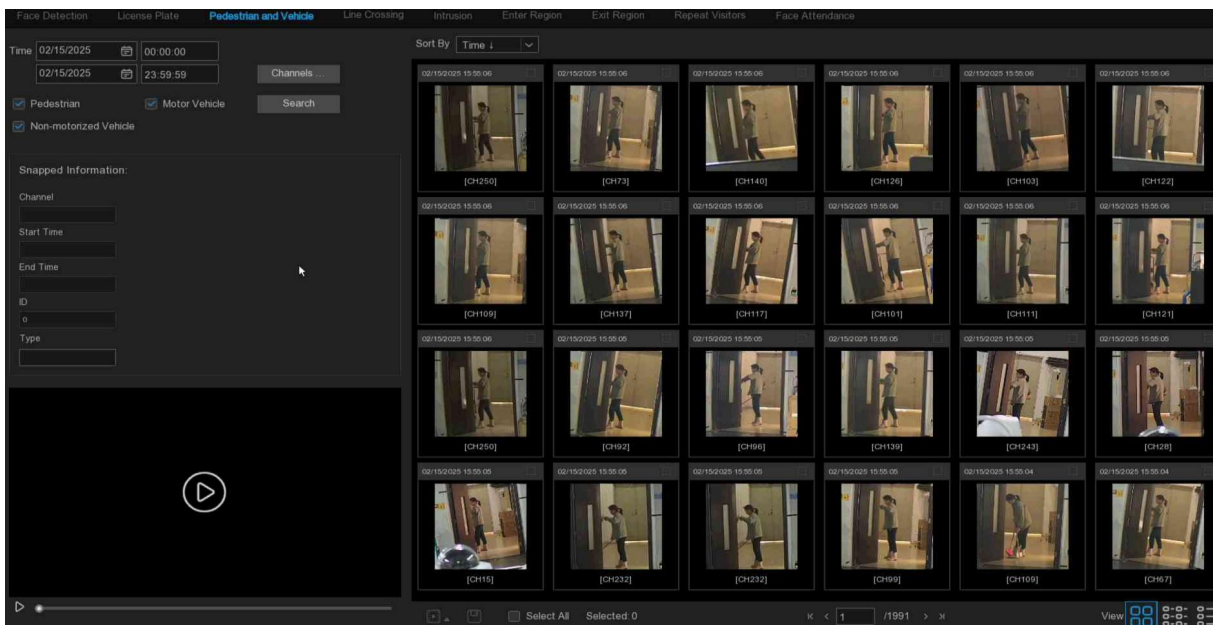

Left click on the left will have basic information, right click to customize the playback and view the details. Click on the lower left corner to play for simple playback, double-click to zoom in, and enter the normal playback mode.

7.1.9.4 Line Crossing

After selecting the date, time, channel, and alarm type, and person and car type, click search for the alarm information triggered by the grouped person and car during this time

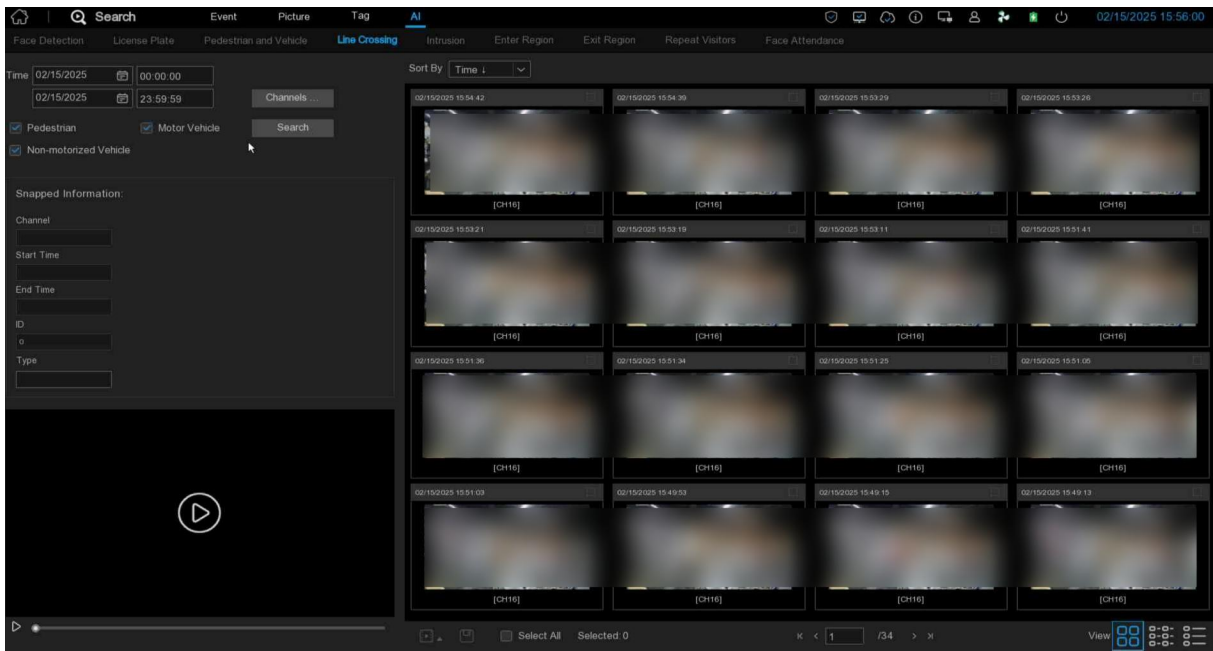

period.

Left click on the left will have basic information, right click to customize the playback and view the details. Click on the lower left corner to play for simple playback, double-click to zoom in, and enter the normal playback mode.

7.1.9.5 Intrusion / Enter Region / Exit Region

After selecting the date, time, channel, and detection target type, click **Search** to search out the alarm events captured in the selected time period.

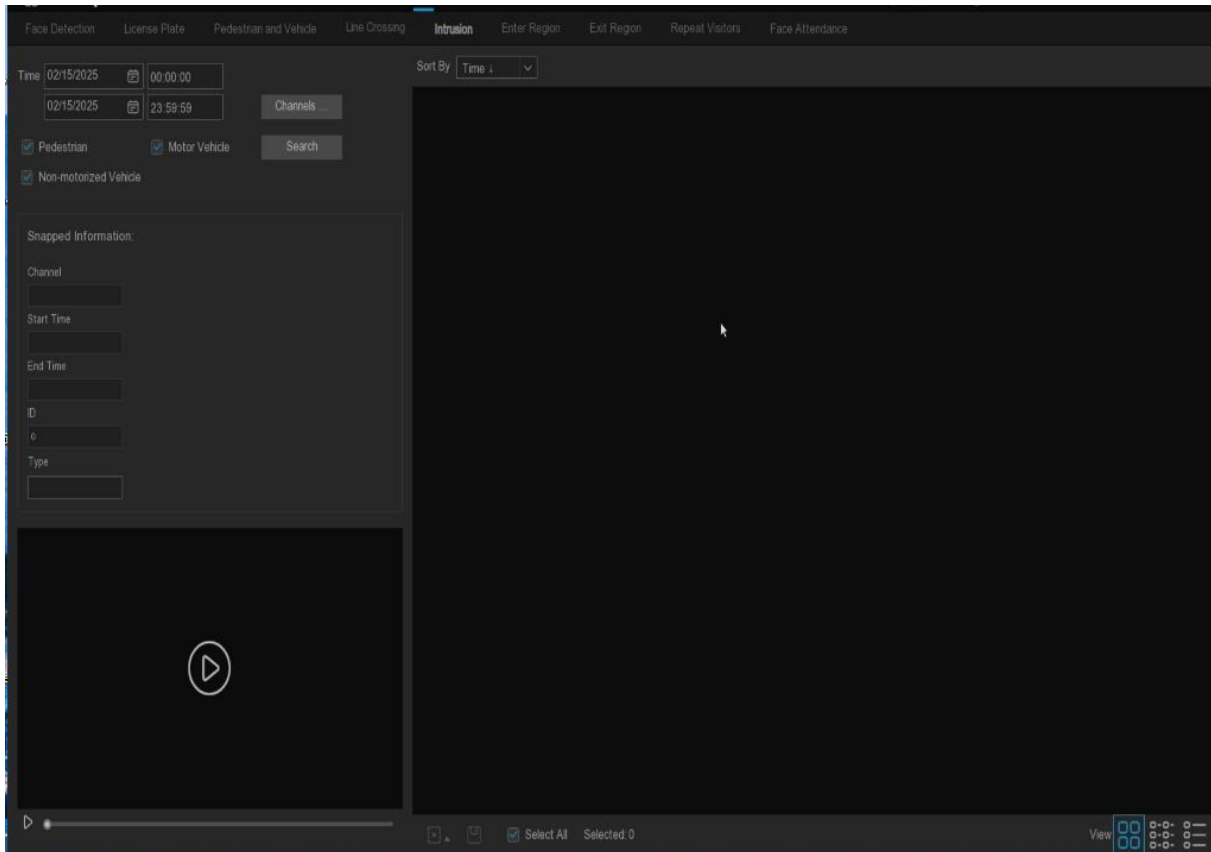



7.1.9.6 Repeat Visitors

7.1.9.6.1 Real-time Repeat Visitor

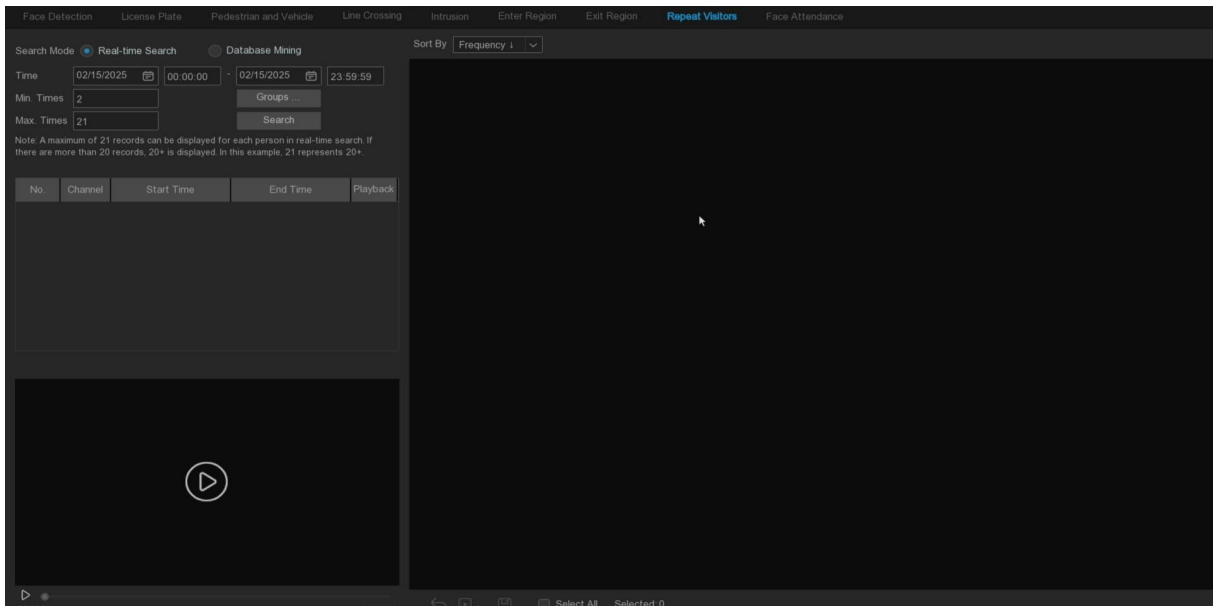
Search Mode Select Real-time Search to retrieve the statistical results of the personnel frequency analysis.





1. Select the date and time that you need to search for.
2. Select the face library group to compare and search group by default.
3. Select the minimum and maximum number of people to search (over 20 times please enter 21).
4. Click the Search button, display the search results on the right side, and display the number of times of the person at the bottom of the face grab map.
5. Click the search results, there will be detailed playback and information on the left, right click to import the face library or edit the face library image information and view the detailed information.
6. Click Sort By to sort, in order of time or quantity.
7. Check the search results or Select All. Check all the search results, click the icon  to customize the play, or click  the picture and video backup to the USB storage device.

7.1.9.6.2 Database mining

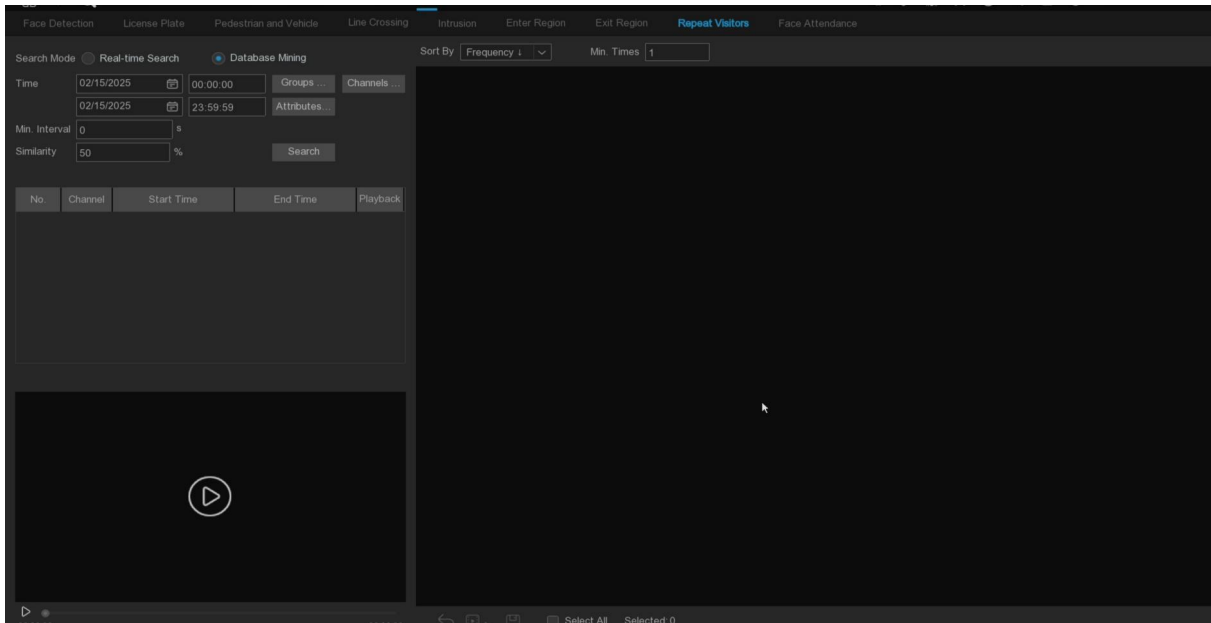
Search Mode Select Database Mining can be retrieved and counted for the number of times of the same face according to the similarity and face attributes.



1. Select the date and time that you need to search for.
2. Select the face library group to be compared, and search group.
3. Select the channel that you need to search for.
4. Select the corresponding face attributes in the face attribute Attribute interface.
5. Enter the number of seconds of the minimum interval.
6. Left click the search result, click the search result, there will be a detailed playback and information on the left, right click to import the face library or edit the face library picture information and view the detailed information.
7. Enter the minimum number of face appearances at Minimum Times for screening.
8. Click Sort By to sort, in order of time or quantity.

9. Check the search results or Select All, select the search results, click the icon  to customize the play or click the picture  and video backup to the USB storage device.

7.1.9.7 Face attendance

The attendance system can check if someone appears within the specified time. And automatically determine whether they are late or leave early.

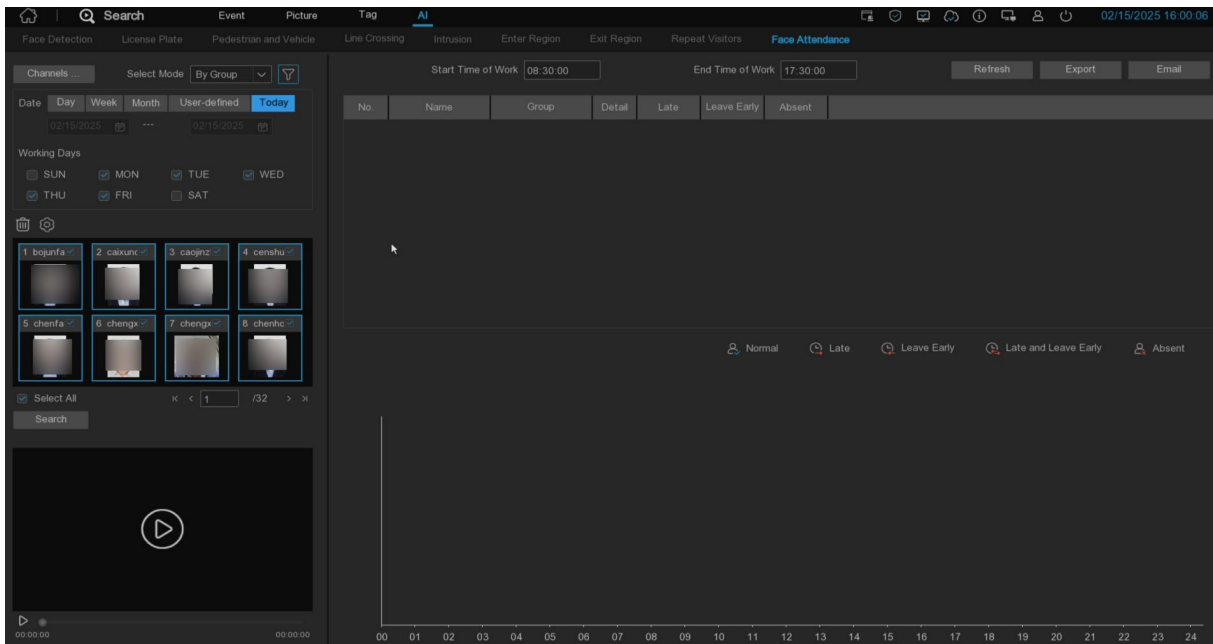

1. **Channels:** Choose the channel for face attendance
2. **Select Mode:** Select the face picture of attendance, By Group and By Person
 - By Group:** Select the face picture through the face group, that is, add all the face pictures of the group.
 - By Person:** Select the face map, click the right button to pop up the face map interface of the face library.
3. **Date:** Select the search date, the default is the system time day, there are five selection modes: Day, Week, Month, User-defined, Today.

4. **Working Days:** Select working days
5. **Start Time of Work:** Set the working hours
6. **End Time of Work:** Set the closing time
7. Click on the Search. You can search out the results.

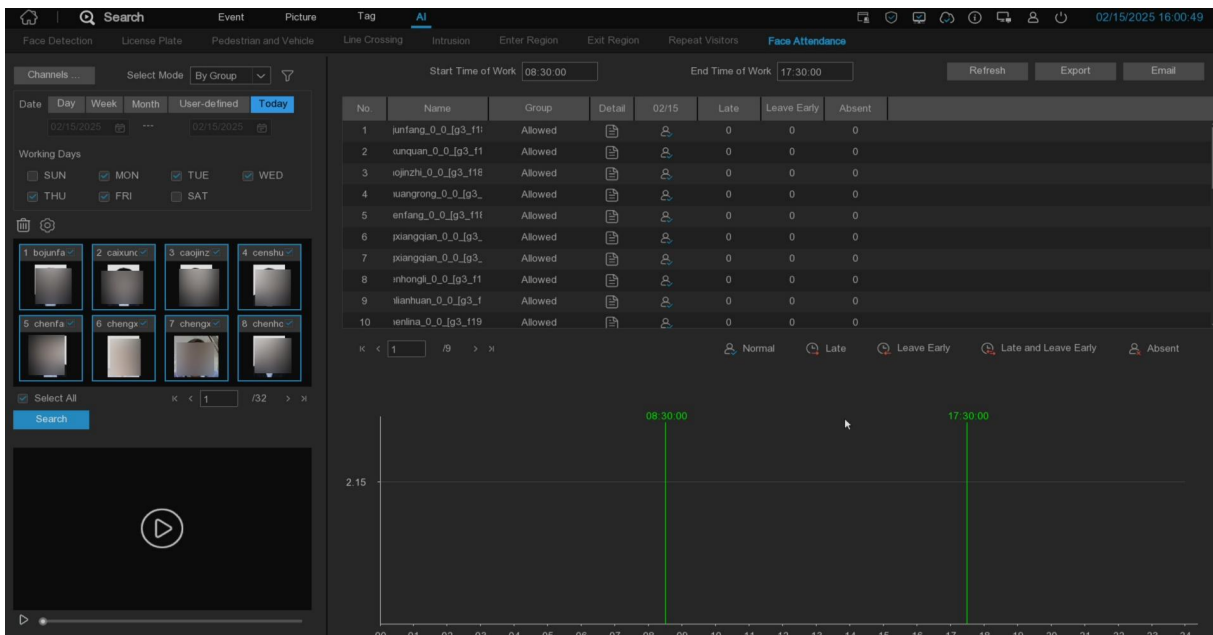

Click on a result, and all the detection records will be displayed below. Click  to the detail icon



to enter the details interface.

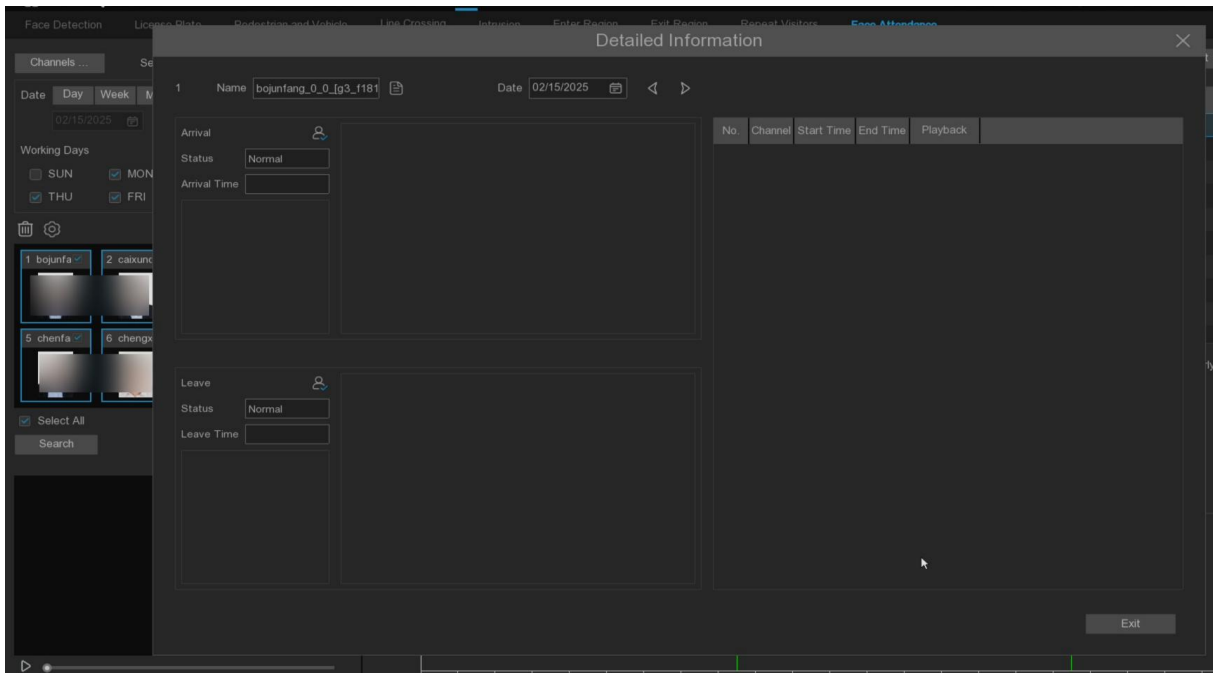

There are details on attendance, including the first appearance and the last appearance. Click



to make a simple playback in the lower left corner.

Click [Export](#) to save the searched attendance information generation file to the U disk.

Click [Email](#) to send the searched attendance information generation file to the mailbox.

Chapter 8 Remote Access through the Web Client

Access the device remotely at any time through a PC using a Web client. Make sure the device network is working before accessing the Web client.

8.1 Basic environment requirements of the system

The minimum requirements for the hardware and operating system required to run the Web client are shown below.

project	least value	Recommended value
CPU	Intel® Core™ i5 CPU	Intel® Core™ i5 CPU or higher
Run memory	4G or more	8G or more
hard disc drive	And 500G or more	And 500G or more
Display memory	2G or more	4G or more
Displays the resolution	1280*1024	1920*1080
OS	Windows 7 Or above Mac OS X® 10.9 or above	
DirectX	DirectX 11	
Direct3D	Acceleration Function	

Ethernet adapter	The 10 / 100 / 1000M Ethernet adapter
IE browser	Microsoft IE browser (Version: 11,10)
Firefox browser	V52 and above
Google browser	V57 and above
apple Safari	Version 12.1 and above
Edge browser	V79 and above

8.2 Download and installation of the Web plug-in

To access the Web client, follow these steps:

1. Open the browser, enter the IP or DDNS + port number of the device in the URL box, and enter the correct user name and password in the user information verification page to login to the web client.(Five consecutive password errors will be locked for 180s)

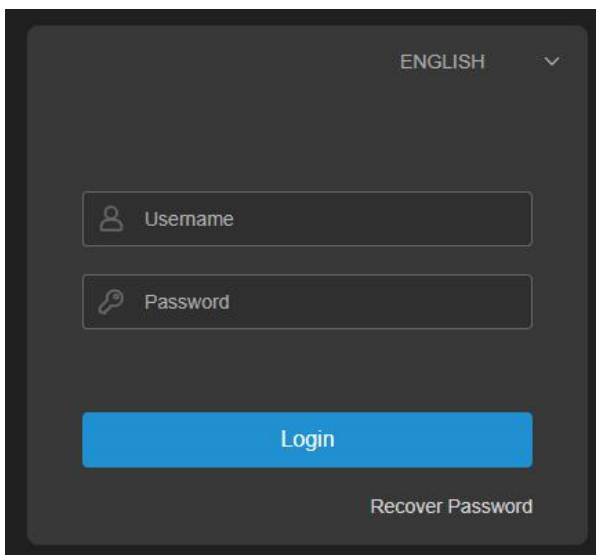

2. When you first visit the IE browser, the system will require a plug-in. Click on Download and install the player to download the plug-in and install it to the computer.

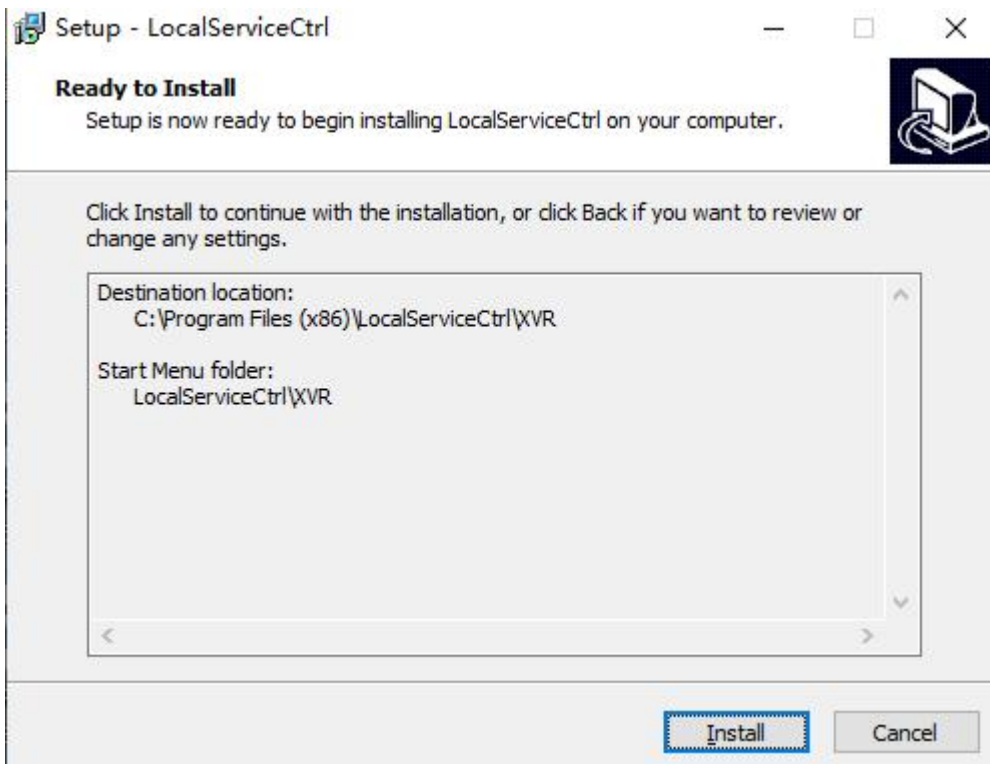
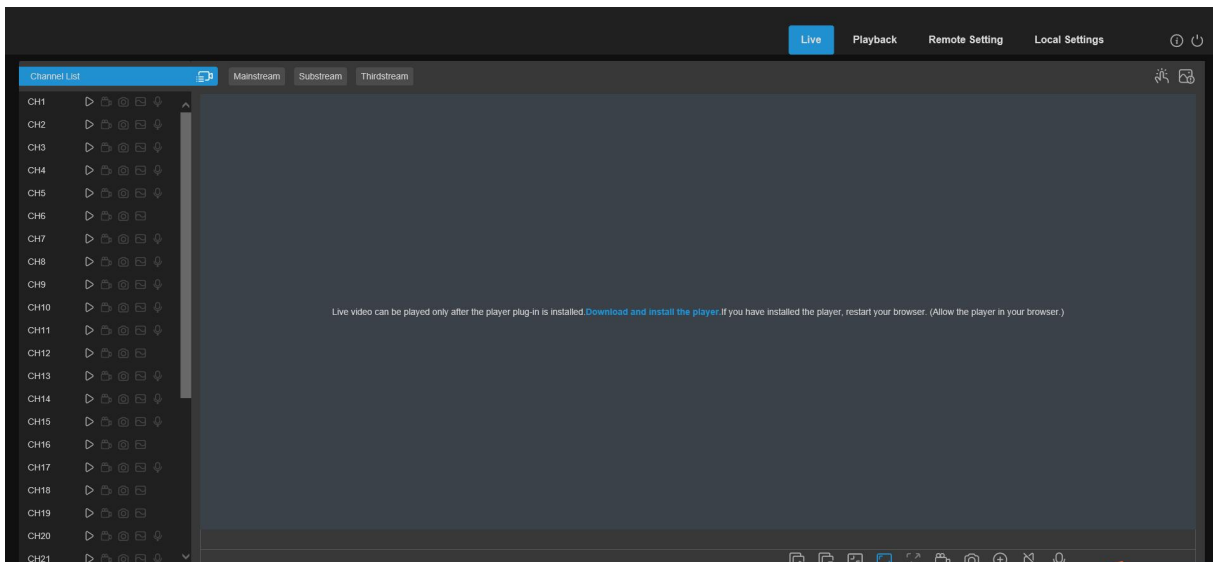

3. After installing the plug-in, refresh the page, click the permission in the pop-up window at the bottom of the page, and then use the diagram normally.

Note: When using Apple Safari / Google browser / Firefox browser / Microsoft Edge browser, you do not need to download the plug-in, and you can directly login and access to the device.

8.3 Web Client Management



8.3.1 Preview interface

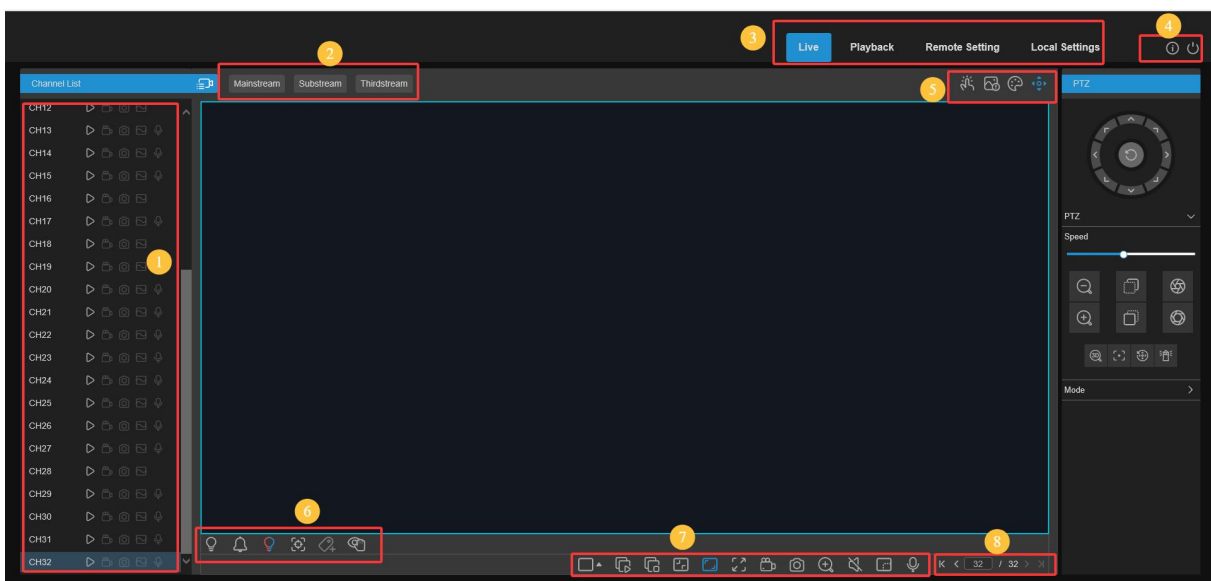

After the Web side verifies the user information through the device, enter the real-time preview page of the device. This page can open or close the real-time preview, manually record video to the local computer, snapshot of the screen, cloud head control, color adjustment, etc.



1. List of channels

Click  the list of channels.

Turn the live video stream on  / off , and the icon appears blue when the live video stream is on.

Click  to start  manually recording the streaming video. Click again to stop the recording. Manual video recording is saved to the computer. On video recording, the icons are colored in blue.

 Manual snapshot icon. Click to save the current live-displayed snapshot to the computer.

 Bitrate icon. The camera is set to use mainstream, substream or mobile stream video settings, which is only for IP channels.

2. Code flow switch

The Web automatically cuts into the main stream mode when watching single split screen, and into sub stream mode when watching multi-split screen. Users can select the appropriate code stream mode according to the actual network environment.

3. Main menu:

Preview: Real-time access to device video streams

Replay: remotely play the video stored on the device side

Remote settings: Remote sets the device

4. Mouse over  to display the system user and web version information



 withdraw from web

5.  **Manual Alarm:** Manually open or close the IO alarm

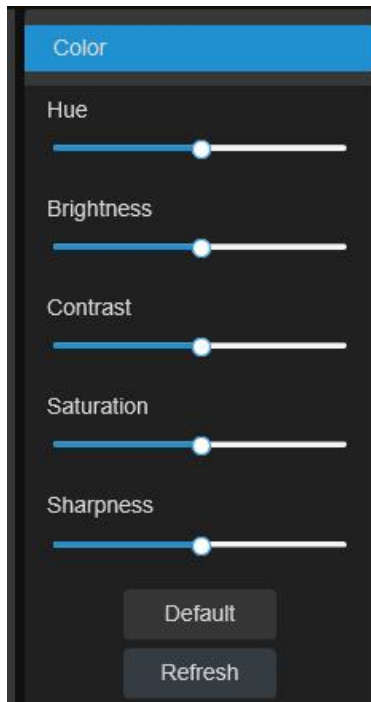

 **Color settings:** Click to display or hide the color control.



 **AI alarm:** Push the AI alarm events, click to  check the AI push type, push the selected type of AI alarm events, and click  to empty the current push list

- All
- Face Recognition
- Pedestrian
- Motor Vehicle
- Line Crossing[Pedestrian]
- Line Crossing[Motor Vehicle]
- Non-motorized Vehicle
- Line Crossing[Non-motorized Vehicle]
- License Plate Recognition
- Intrusion[Pedestrian]
- Intrusion[Motor Vehicle]
- Intrusion[Non-motorized Vehicle]
- Region Entrance[Pedestrian]
- Region Entrance[Motor Vehicle]
- Region Entrance[Non-motorized Vehicle]
- Region Exiting[Pedestrian]
- Region Exiting[Motor Vehicle]
- Region Exiting[Non-motorized Vehicle]
- Package Delivered
- Loitering
- Package Taken Away

PTZ control: Click  to open or close the PTZ Operation menu.

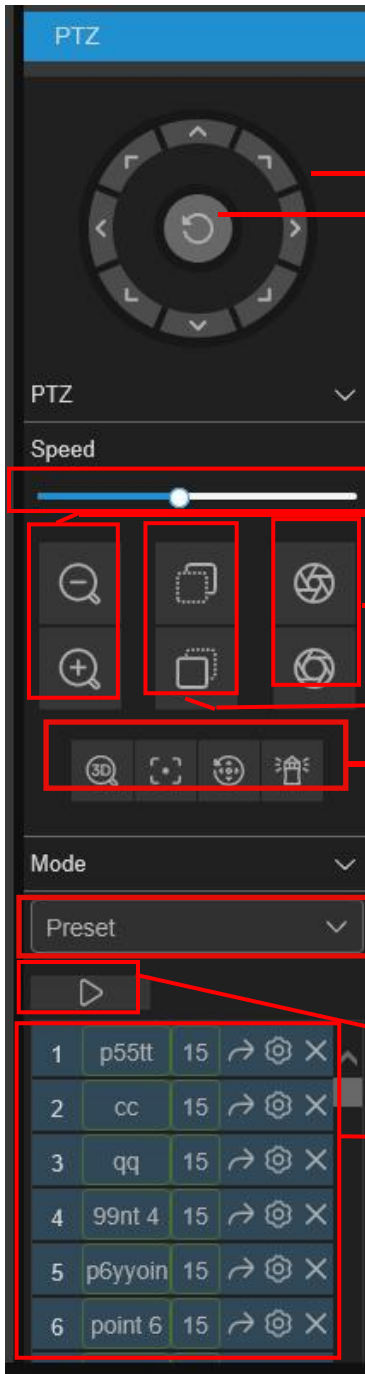

Direction arrow: Click to turn the PTZ camera

Default cruise

PTZ speed: Set the speed at which the PTZ camera rotates.

Zoom: Click- - / + to zoom in or out.

Aperture: Click to adjust the aperture size.

Focus: Click- - / + to adjust the focus.

It is the 3D DPTZ, it is the automatic focus, it is the reset preset point, it is the watch mode

PTZ rotation mode, with six modes: PTZ, PRESET, Line Scan,

Watch Mode, Tour, and Pattern Scan.

Cruise: Start / stop the head cruise

Preset point: modify the preset point name, go to, add, and delete the preset point.

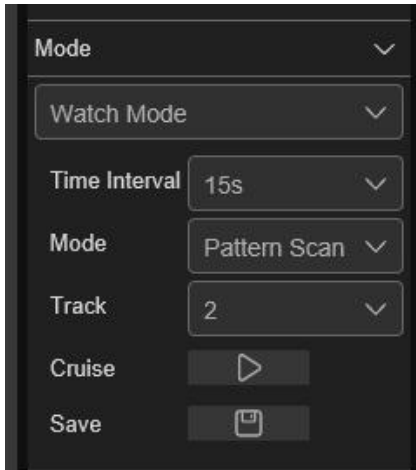

Watch Mode Page:

Time Interval: Watch wait time, stop operation to continue watch action.

The interval time Mode: Select the watch mode , you can choose the default, preset point, linear scan, track cruise, pattern scan.

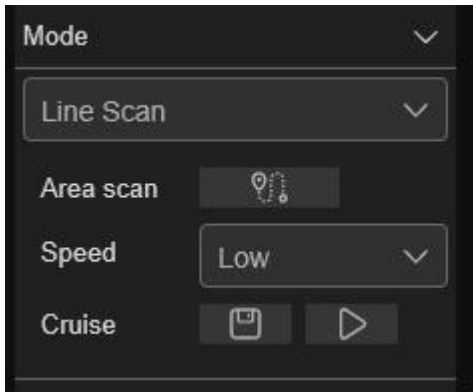

Line Scan Page:

Area scan: Click  the record start position, turn High-Speed Dome, and click  the record end position.

Speed: Select the linear cruise speed.

Click  to start the linear cruise, and High-Speed Dome moves only in the same level schedulee in this mode.

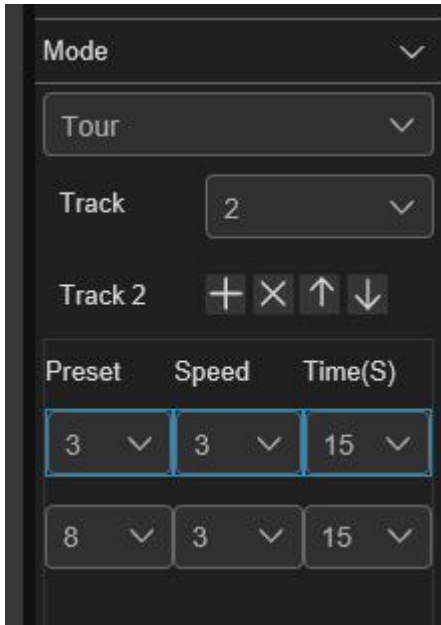

Tour page:

Time Interval: Dwell time of each preset point

Click Add Preset, click Delete, click Up / Down, and click Start Cruise.

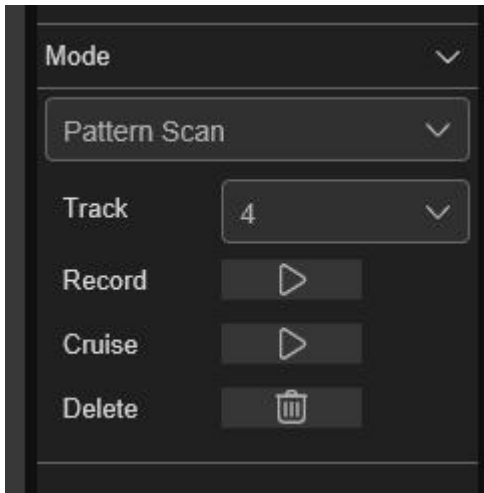









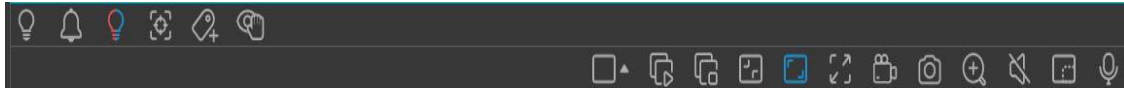









Pattern Scan Page:

Record: Click to start recording the cruise route, and click to stop recording.

Cruise: Click to start cruising following the previously recorded route and action.

6. Live View Control Buttons



-  The channel window switches over the display mode
-  Open all the channel previews
-  Close all channel previews
-  Original proportion: Display the live video according to the original proportion
-  Stretch: Stretch live video to fit the entire area of each channel on the screen
-  Zoom in the web client to full screen
-  Manual recording: Click to start a manual recording for all of the display channels. Click again to stop the recording. Manual video recording is saved to the computer
-  Manual capture: click to grab the picture of all the current display channels to save to the computer
-  Electronic zoom: Click on an active image, then click-drag over an area of the active image to zoom in. Right-click to return to the normal display.
-  Volume control: by adjusting the volume of the level. Silent  mode
-  Intertext icon: Click Open the intercom between the client and the device, and click close the intercom with the device again (Note: this function requires the device to support the intercom function)
-  White light control, can manually turn on the white light deterrence (need camera support).
-  Warning alarm control, can manually open the alarm warning (need camera support).
-  Red and blue light control, can manually open the red and blue light warning (need camera support).
-  Area focus, click the button, use the mouse to preview the area, the camera lens will focus according to the sliding area.(Zoom camera support only)
-  Click on the Add a Custom Tab event.
-  Privacy mode (requires camera support).



Fisheye mode: This button is displayed when connected to a camera supporting fisheye, and click the button to enter the fisheye mode preview (only some NVR models support fisheye mode)

7. Switch to the display paging

8.3.2 Playback

This page can search and replay videos stored in the device's hard disk, and can download videos to the PC.

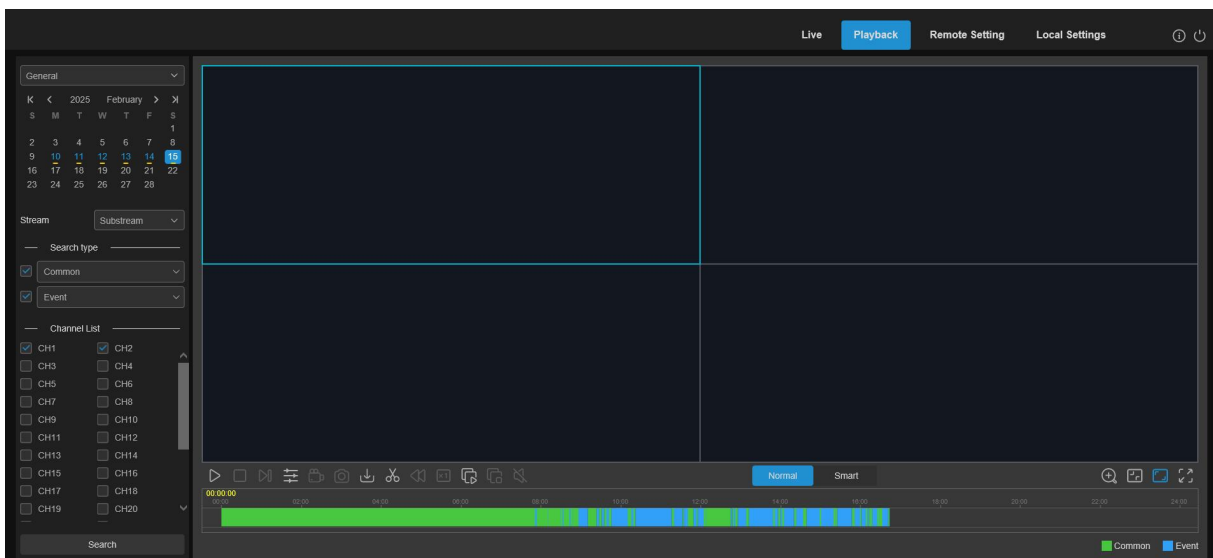





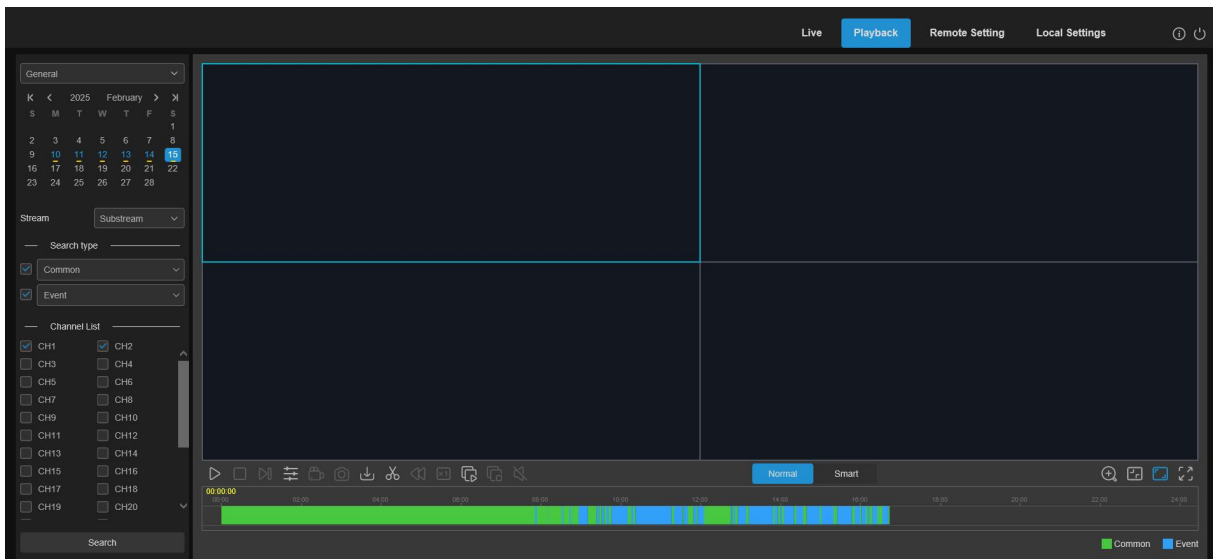

Search video:

1. Click on the upper right corner to play back the Playback, and the icon enters the playback interface
2. Select the date to query the video on the calendar. Days with video recording are shown as red underlined.
3. Select the type of video to query in the Type.
4. Select the video stream that you need to search for and play to.

5. Check the channel back in the "channel".(Up to four channels simultaneously)
6. Click on the search element Search icon to search for the video.
- 7, the video of the search will be displayed on the timeline. Click the video clip you want to start playing, and then click the play icon to play the video.

8.3.2.1 General Playback



-  Play a single video
-  Single video is suspended
-  Stop playing a single-channel video recording
-  Play by frame:: the first frame and move by playback. Available only when the Sync playback option is not selected.
-  Sync play: Click to synchronously play the selected channel simultaneously at the same time
-  Click to select a playing channel, and then click the recording icon to record the current video to the computer. Click again to stop the recording.



Click on one of the channels that are playing, then click the capture icon to take a snapshot and save to the computer.



Open the Download menu to download a video of the selected type of time for the selected channel.

	<input type="checkbox"/>	Start Time	End Time	Status	File Size
1	<input type="checkbox"/>	2025-02-15 00:00:01	2025-02-15 02:13:50	Not Downloaded	195.11M
2	<input type="checkbox"/>	2025-02-15 02:13:46	2025-02-15 07:51:13	Not Downloaded	491.78M
3	<input type="checkbox"/>	2025-02-15 07:51:13	2025-02-15 07:51:45	Not Downloaded	0.87M
4	<input type="checkbox"/>	2025-02-15 07:51:45	2025-02-15 07:52:15	Not Downloaded	0.75M
5	<input type="checkbox"/>	2025-02-15 07:52:15	2025-02-15 07:53:19	Not Downloaded	1.59M
6	<input type="checkbox"/>	2025-02-15 07:53:19	2025-02-15 07:53:49	Not Downloaded	0.77M
7	<input type="checkbox"/>	2025-02-15 07:53:49	2025-02-15 08:10:21	Not Downloaded	24.10M
8	<input type="checkbox"/>	2025-02-15 08:10:21	2025-02-15 08:10:53	Not Downloaded	0.79M
9	<input type="checkbox"/>	2025-02-15 08:10:53	2025-02-15 08:28:42	Not Downloaded	25.07M
10	<input type="checkbox"/>	2025-02-15 08:28:42	2025-02-15 08:29:12	Not Downloaded	0.73M
11	<input type="checkbox"/>	2025-02-15 08:29:12	2025-02-15 08:32:18	Not Downloaded	4.40M
12	<input type="checkbox"/>	2025-02-15 08:32:18	2025-02-15 08:32:50	Not Downloaded	1.09M
13	<input type="checkbox"/>	2025-02-15 08:32:50	2025-02-15 08:33:24	Not Downloaded	1.04M
14	<input type="checkbox"/>	2025-02-15 08:33:24	2025-02-15 08:33:54	Not Downloaded	0.80M

14 Row / Page < 1 / 31Page >

Start Download Stop Download

Select the file to download, press the Start Download icon to start the download, and will display the download status. Press the Stop Download icon to stop downloading.



Cut the backup, and download the video  button of the cut time period to the PC local.



Back forward, only available when the sync playback option is not selected.



Playback speed: Click to select the play speed.



Play all channels: Click Play all channels for select search. Available only when the Sync playback option is not selected.

 Stop playing all channels: Click to stop playing all channels. Available only when the Sync playback option is not selected.

 Electronic zoom: Click the video you are playing, and then click and drag an area of the video to zoom in. Right-click to return to the normal display.

 Original scale:: Display the video being played in the original scale.

 Stretch: Stretch the played video to fit the entire area of each channel on the screen.

 Zoom in the web client to full screen play.

8.3.2.2 Picture Playback

After the device sets the picture, the pictures captured by the device can be searched on this page. Maximum of 5000 pictures can be searched for a single time, and the time interval can be modified according to the need.

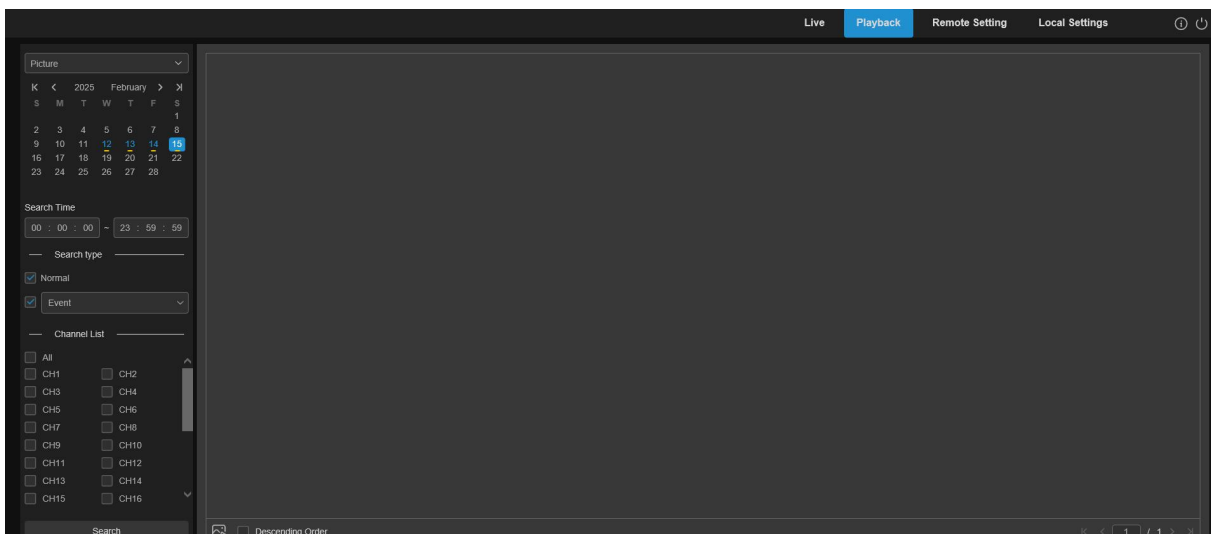

Search capture map:

1. Click on the Playback in the top right corner of the window.
2. Select Picture from the drop-down menu in the upper left corner.
3. Select a date search on the calendar, with a red underline.



4. Select the type of image to search from the list in the Search Type menu.
5. Check the channel to search for the video.
6. Click on the Search.
7. The picture that meets the search criteria will be displayed on the right side. When

double-clicking , the playback video of the time period before and after the picture will be played, and click to return to the previous interface.

8.3.2.3 Smart playback

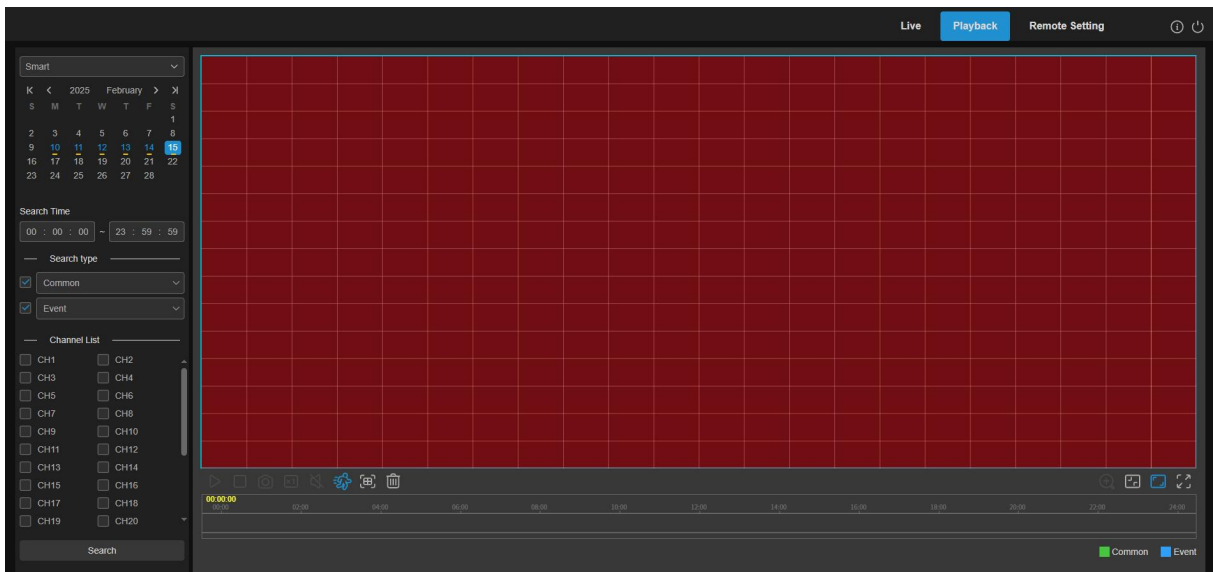
The device will be marked as a smart type when it detects a change in the screen, and it can search for a Smart Playback video.



Click  to display smart setting area, click  to select all areas, click  to clear all selected areas.

8.3.2.4 Tag playback

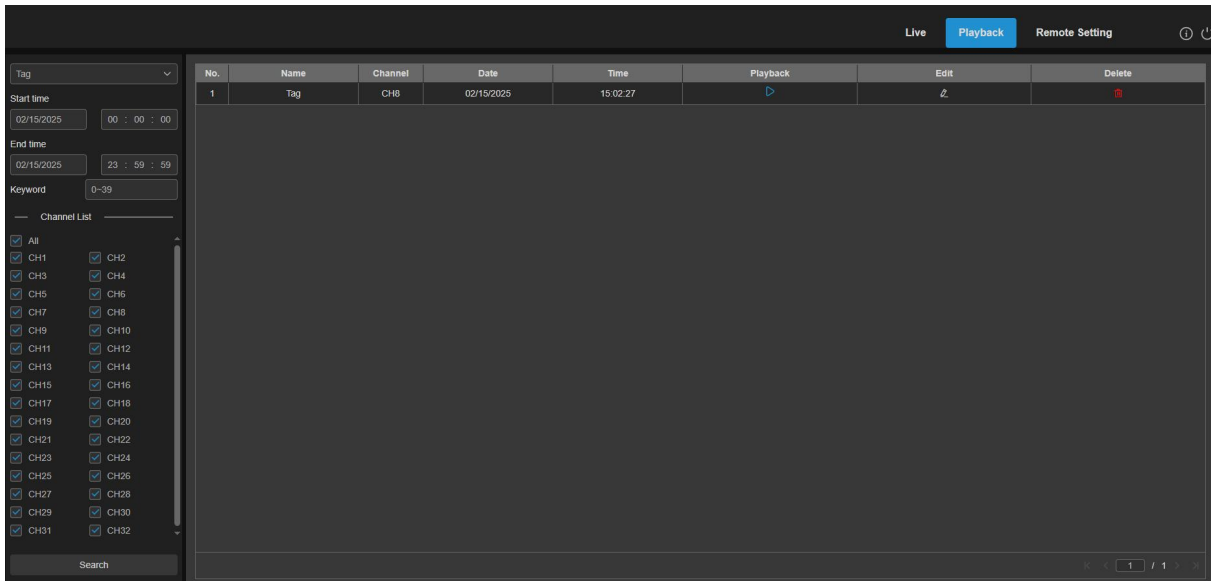

This page searches for all the added tags and ed, plays back, or removes them. Select the time and channel and click on  the Search to complete the search. Click to jump to the position marked by the label for playback.

8.3.2.5 AI playback

After the device opens the AI alarm, the AI alarm event search can be conducted on this page, including face detection, license plate detection, pedestrian and vehicle detection, PID & LCD, repeat customers and face attendance type events.

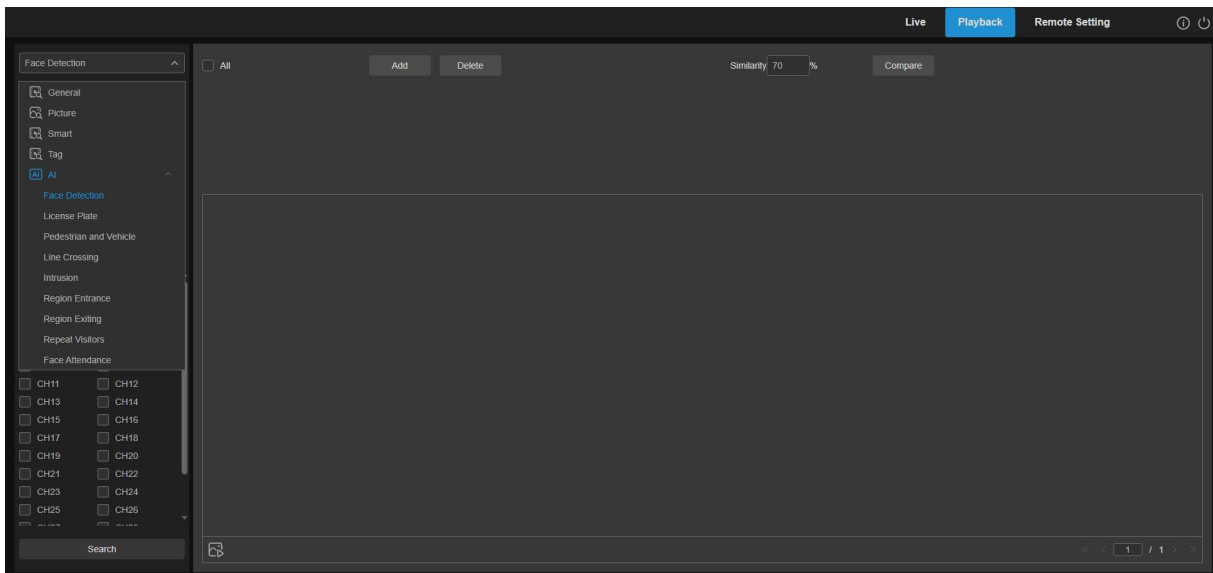

8.3.3 Remote Settings



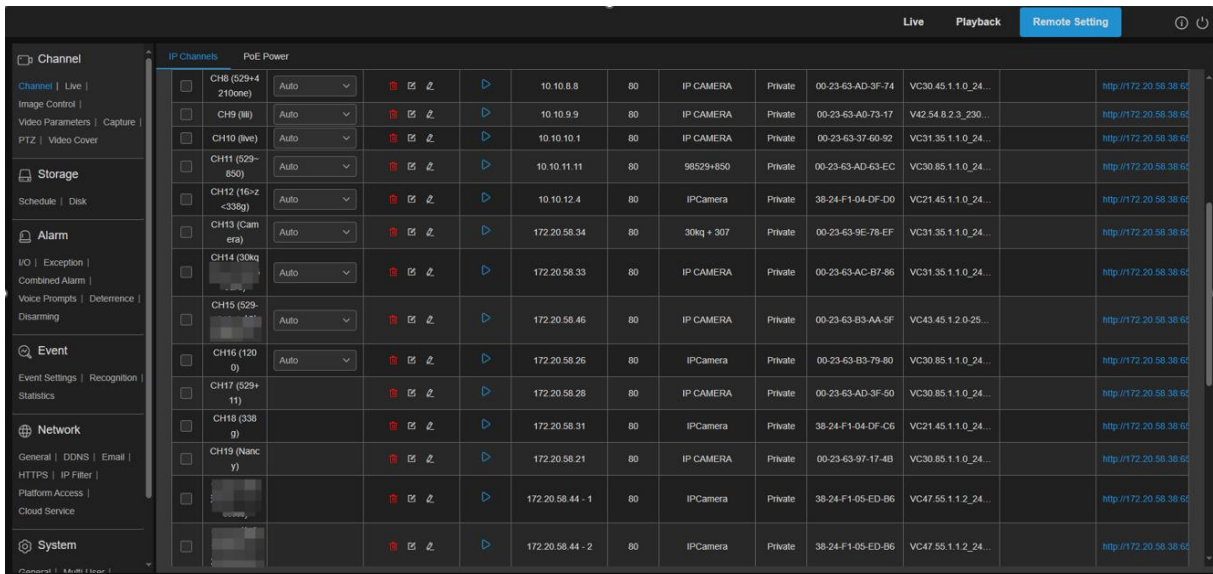

This interface supports remote configuration of device parameters, and channel, video recording, storage, alarm, event, network and system parameters.



8.3.4 Local settings

Set the download location for videos and snapshots taken through the Web client and select File Type for the video file.

Path configuration

Record Path	D:\Device\Record	
Download Path	D:\Device\Download	
Snapshot Path	D:\Device\Capture	
File type	MP4	
Capture Type	JPG	

Save

Record Path (Manual recording path): Click  Browse and select the folder where you need to save the manual recording on the computer.

Download Path (Video download path): Click  Browse and select the folder you need to save to the computer.

Snapshot Path (Grab path): Click Browse  and select the folder where you want to save the manual captured snapshot on your computer.

File Type (File type): Select the manual video recording file type.

Save (Save): Click to save the modification.

Chapter 9 Play the backup video

This section will help users to play video files backed up from the device using the VideoPlayer player.

Computer system minimum requirements

- Intel I3 and above CPU
- Microsoft Systems 7 / 8 / 10 / 11, MacOS 10 and above
- And 8GB of memory

1.Install the video playback software in the CD and run it.

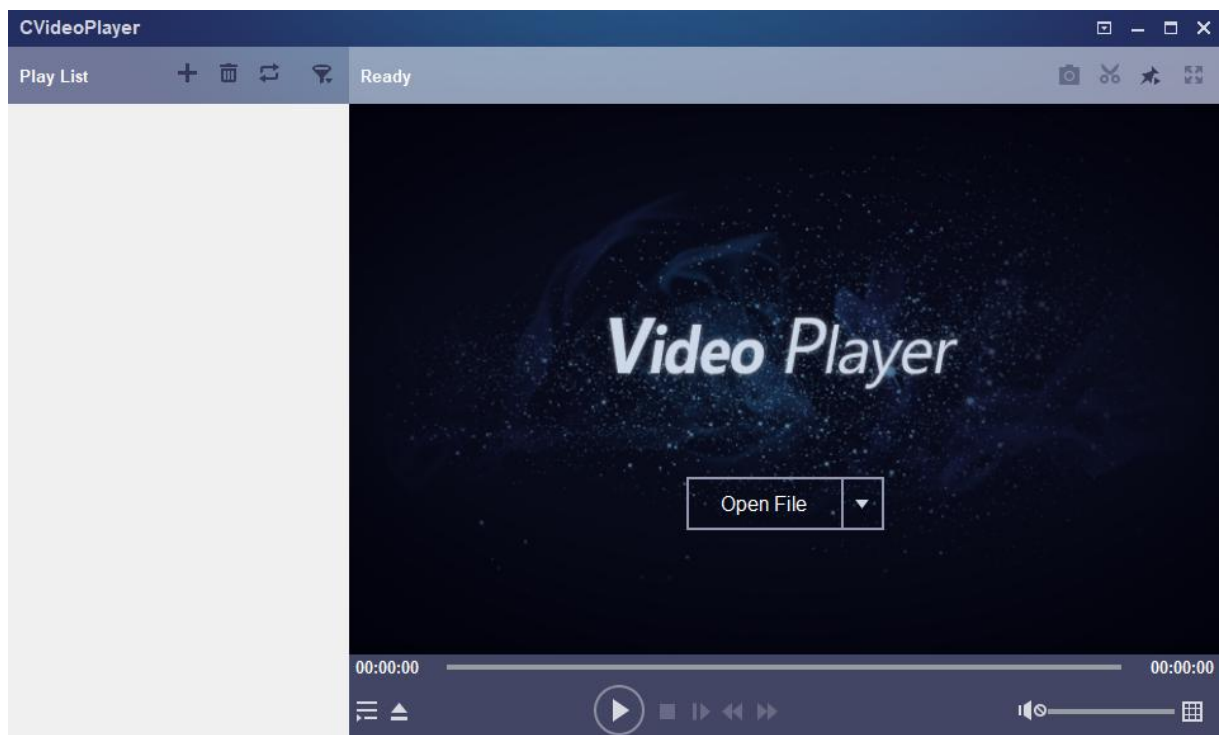

2.Copy the backup files to your computer.

3. Click the Open file icon or click the + icon in the playlist to load a single or multiple video files. It supports adding and playing the ".avi", ".mp4" format file. Click on the icon to load the backed-up video folder.

Video Player Control



1. Playlist

Add file

Deleted file

Select play mode: play a single file and stop. play all listed files in order. play one file repeatedly and play all files repeatedly

Filter by file name

2. Hide / display the playlists

Click to Open the file or to load the folder

3. play control

 Play

 Pause

 Stop playing

 Play by frame: Click to play a video

 Slow playback: 1 can set 1 / 2, 1 / 4, 1 / 8 and 1 / 16 times playback

 Fast forward: You can set x2, x4, x8 and x16 times of playback

 Volume control

 Multi-screen playback: you can play multiple videos at a time. When you select Multiple Screen Play, you can drag and drop videos from the Playlist to the Play screen.

 Snapshot

 Save a video clip to the computer. Press Start once and Press End the video clip again.

 Put the video player on the top

 The video window is displayed in full-screen

 The Advanced Settings menu selects the language of the player to configure the player function.

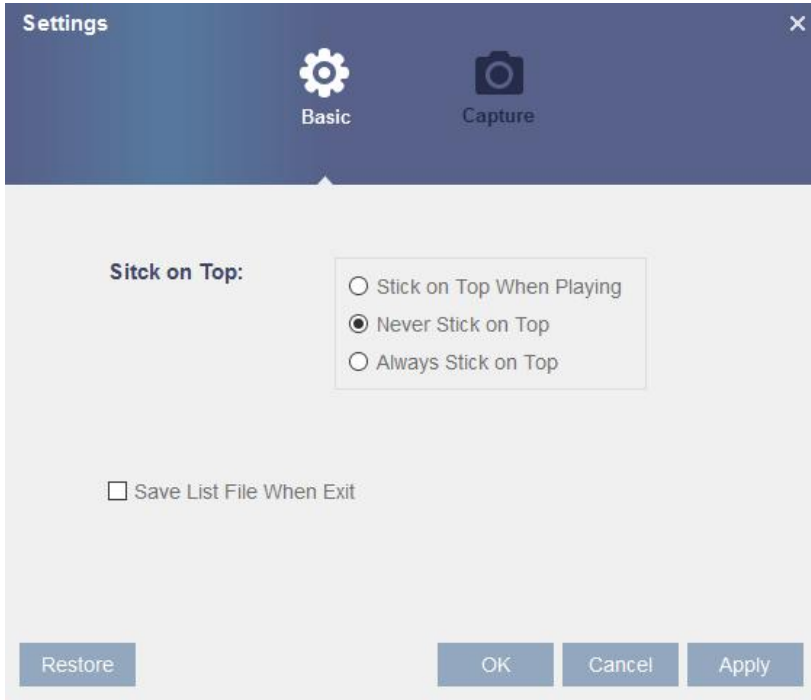

Basic Settings: Set the top-setting mode

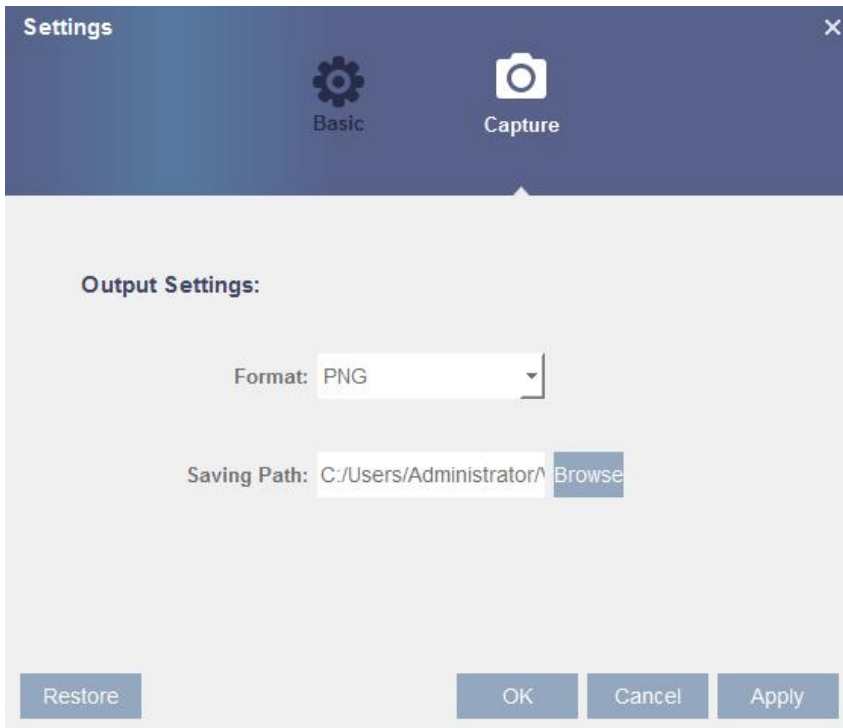

Capture Settings: Set the save format and save path of the snapshot.

Chapter 10 Remote access via a mobile device

The device supports remote access through mobile devices based on Android and iOS operating systems, and Android and iOS devices can search for RXCamView and CybVu in Google Store and Apple store respectively.

10.1 RXCamView

1) Run the application and will display a live viewing screen.

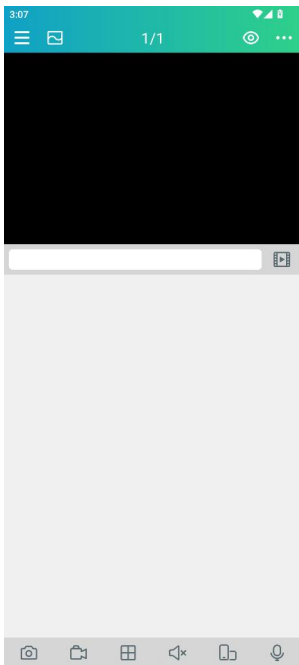

2) Click the icon  to open the menu, select the device list "Device List", and click "+" to add the device..

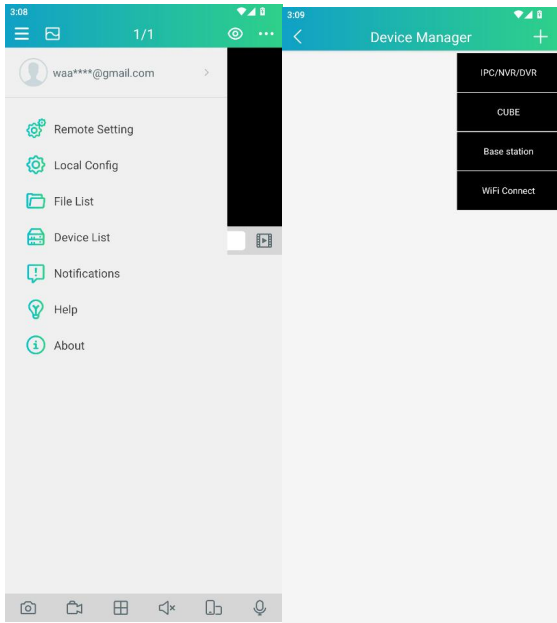

3) Select manually Add Manual Add, enter device information, and add a new device.

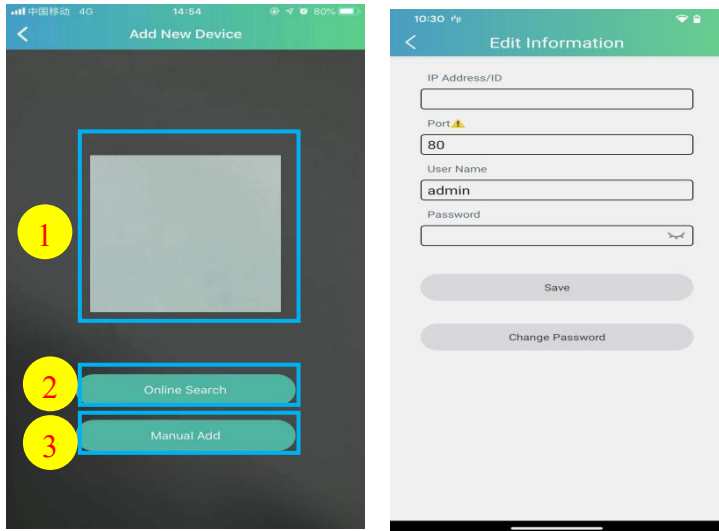

1. Scan the QR code: scan the QR code to add the equipment

2. Online search: in the same LAN as the device, search to add

3. Manual addition:

IP Address / ID: Enter the IP address or enter the P2P ID

Port: The input device port

User name / Password: Enter the user name and password of the device

4. After all the Settings are completed, click Save. When the device is well connected, the app will turn to the real-time display.

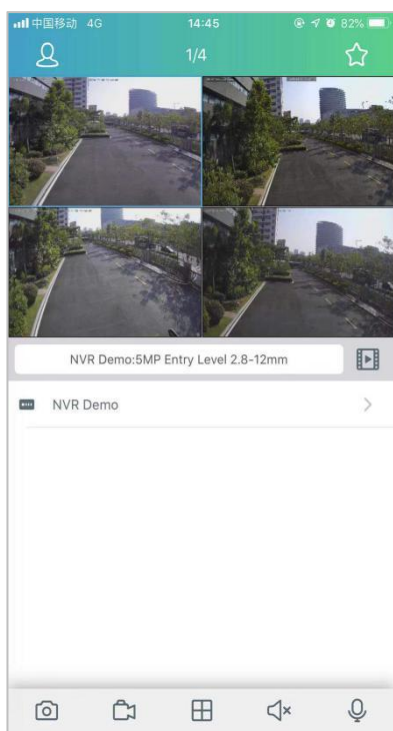



- 1-channel display
- 4-channel display
- 6-channel display
- 8-channel display
- 9-channel display
- 16-channel display

NOTE: The app displays up to 16 channels in one screen

interface, swiping the screen left and right to move to the next

screen to view the other channels



 Capture: capture the image of the selected channel screen, save it in the APP file list, and you can download the captured picture to the mobile phone in the file list

 Video recording: record the selected channel screen and save it in the APP file list, which can be downloaded to the mobile phone in the file list

 Audio: Turn the sound on or off

 intercom: two-way device intercom (requiring equipment support)

 PTZ control (video camera support required)

 Close the channel: Press and hold down the video image, this icon appears above the window, drag  to pull the video to this icon and close the video preview.

10.2 CybVu

1. Run applications and register Cloud account.

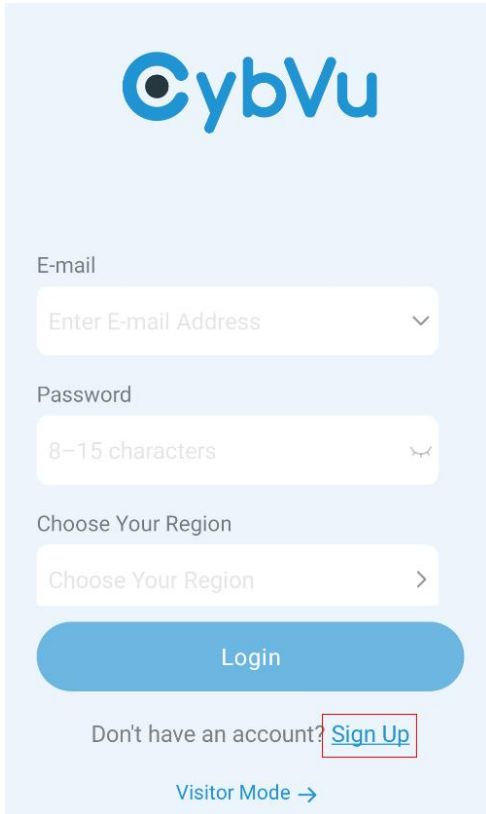

The image shows the CybVu registration interface. At the top is the CybVu logo. Below it are three input fields: 'E-mail' with a placeholder 'Enter E-mail Address', 'Password' with a placeholder '8-15 characters', and 'Choose Your Region' with a placeholder 'Choose Your Region'. A blue 'Login' button is positioned below these fields. At the bottom, there is a link 'Don't have an account? Sign Up' where 'Sign Up' is highlighted with a red box, and a 'Visitor Mode ->' link.

2. Enter the email address, set the account number, password, and register the Cloud account in the country / region where the NVR device is located.

←

Sign Up

Account

Enter E-mail Address

Choose Your Region

Choose Your Region >

Password

8-15 characters

Confirm Password

8-15 characters

! Password Rules

Verification code

Enter Code [Get Verification Code](#)

3. Log in to the registered account, click  button on the Home page to bind NVR.

The APP supports binding devices in three ways.

- a. Scan the Information page of NVR device or the QR code (NVR should be in the same LAN as the mobile device).
- b. LAN online search (NVR should be in the same LAN as mobile devices).
- c. Scan the dynamic QR code on the NVR device cloud service page, please refer to **5.5.2 Cloud**

Service

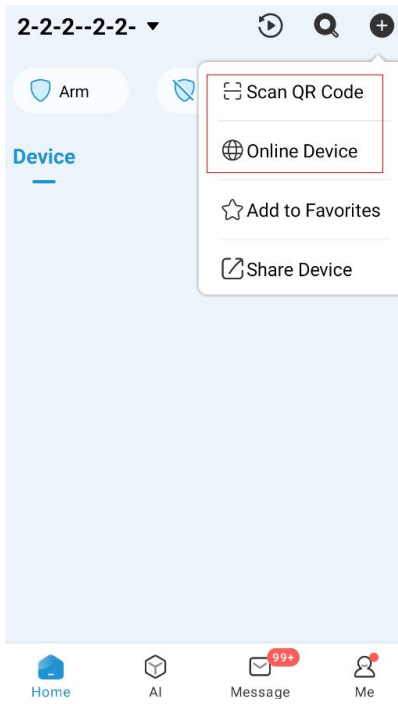

4. After successful binding, the NVR device can be operated on the Home page for parameter setting, preview and playback, share the collection, etc.

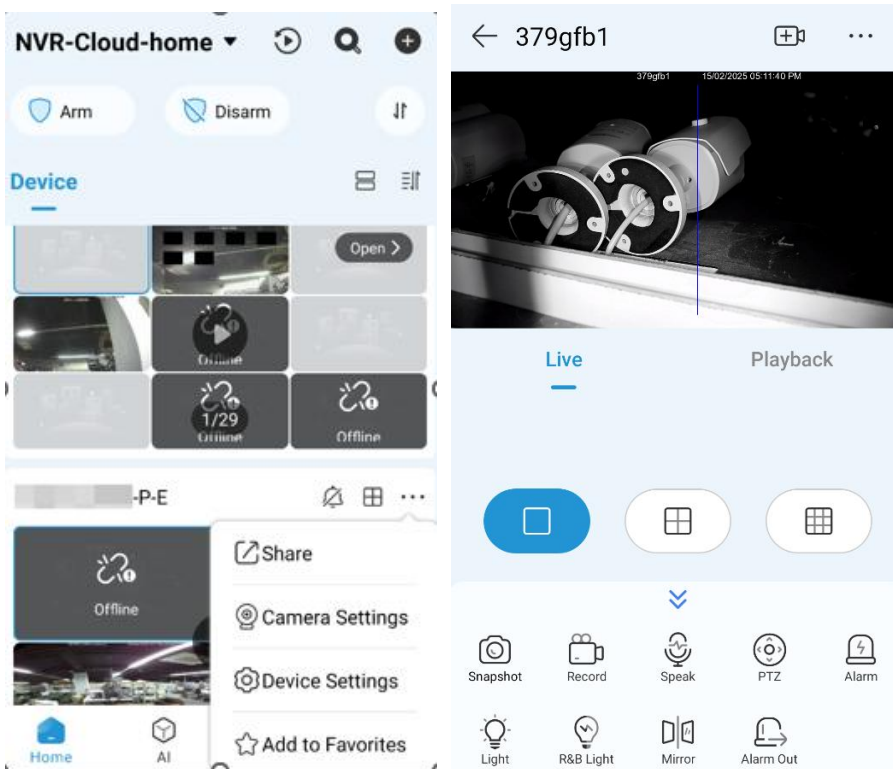

Chapter XI Appendix

11.1 FAQs

1. What should I do if the hard disk is not detected?

A: If the system does not detect the hard disk, please check whether the data cable and the power cord are well connected, whether the interface on the motherboard is faulty, or whether the hard disk you use is supported.

2. After changing the system password, can accidentally forget and can not enter the system?

A: When the administrator forgets the password, he can reset the device through the password retrieval function or restore the factory Settings through the physical reset button. It is recommended that users should set easy to remember and relatively secure passwords when setting the password.

3. Why is the power supply of the equipment and the camera normal but there is no video signal or abnormal images output at the monitor end?

Answer: Please check whether the network cable connection of the device is good, whether the network cable is used for too long and aging, or check whether the selection of N system / P system is consistent.

4. What is the influence of heat dissipation of the equipment?

Answer: The operation of the equipment will generate a certain amount of heat. Please place the equipment in a safe and well-ventilated place to avoid affecting the stability and service life of the system due to the high temperature of the equipment.

5. Why can the remote control of the device not be operated, while the monitoring screen is normal and the panel buttons can be used?

A: If the operation is aimed at the IR signal on the front panel of the body, but the remote control is still invalid, please check whether the battery in the remote control is normal and sufficient. If it is not the above problem, the remote control is broken.

6. If I put a hard drive on my PC into my device, can I use it?

A: It is recommended to use the special hard disk for video surveillance to avoid affecting the stable operation of the equipment.

7. Can you play it back along with the video?

A: Yes, the local system can support the recording back at the same time.

8. Can you clear some video records on the hard disk?

A: Considering the security of the file, you can not clear part of the video. If you do need to delete all the videos, you can choose to format the hard disk.

9. Why can't you log in to the device client?

Answer: Please check whether the network connection mode configuration is correct, whether the RJ-45 interface contact is good, and then when the network login password switch is opened, please check whether your input account and password are correct.

1.What is it like not to find any recorded information when you put the video back?

A: Please check whether the data cable of the hard disk is well connected and whether the system time is being illegally adjusted. Try a few more times, if the above phenomenon still appears after the restart to check whether the hard disk is damaged.

2.Why can't the device control the cradle head?

A: There may be the following reasons:

A) Forward PTZ fault.

B) Incorrect setup, connection and installation.

C) incorrect PTZ setup.

And d) the cradle head decoder protocol does not match the device protocol.

E) The cradle head decoder address does not match the device address.

3. Why doesn't dynamic detection work?

Answer: Check whether the motion detection time and motion detection area settings are correct, and it is to check whether the sensitivity setting is too low.

13. Why doesn't the alarm work?

Answer: check whether the alarm setting, alarm line are correct, and whether the alarm input signal is correct.

14. Why does the buzzer keep chirping?

Answer: check the relevant setting of the alarm, whether the motion detection is open and detected, whether the I/O alarm is normally closed, and check the relevant hard disk alarm setting.

15. Why is the system still recording by pressing STOP or clicking "Stop recording" in the shortcut menu?

Answer: "STOP" or "Stop recording" can only stop the manual recording. modify the recording status of some time to no video. to stop the video recording, change the video mode to the timing or manual recording, and then stop the recording in the above way. Or to stop video can set the channel status in the video setting to close.

11.2 Use and maintenance

1. When the hard disk recorder is shut down, turn off the system in the software interface, and then turn off the power. Please do not directly turn off the power switch, so as not to avoid loss or even damage the hard disk data.
2. Ensure that the hard disk recorder is far away from the heat and source and place.
3. Clean the dust deposited in the body regularly, and keep the box around the hard disk video recorder well ventilated to facilitate heat dissipation.
4. Audio and video signal lines and RS-232, RS-485 and other interfaces, please do not plug plug, otherwise it is easy to damage these ports.

5.Regularly check whether the hard disk power cord and data cable in the body are used for too long and aging.

6.Try to avoid the impact of other circuits on audio and video signals, to prevent electrostatic or induced voltage damage to the hard disk damage.

If the interface connected to the network cable is often plugged, it is recommended that users replace the cable regularly to avoid unstable input signal.

7.This is A Class A product. In a living environment, the product may cause radio interference. In this case, the users may need to take practical measures about the interference.

11.3 Random attachments (subject to the physical object)



Remote Controller



Power Adapter



Warranty Card



USB mouse



CD

Warning:

If the wrong battery is replaced, there is a risk of an explosion

Handle the used battery according to the instructions